



Edgy

Produktdaten

Product information
Information produits

Bretz
True Characters

Elementare Freiheit

Edgy feiert die Gestaltungslust. Das wohl modularste Sofa der Kollektion entstand aus dem Anspruch heraus, Flexibilität, Bequemlichkeit und Einfachheit zu vereinen. Inspiriert vom Tetris-Spiel der Achtziger basiert das System auf Quadern, die sich nach Bedürfnis immer wieder umstellen und neu kombinieren lassen. Mit seiner funktionalen Haltung, der klaren Formensprache und Fähigkeit, sich ad hoc auf neue Situationen einzustellen, geht Edgy auf den urbanen Lebensstil ein. Abgerundete Ecken und eine durchdachte Polsterung bescheren Komfort auf fühlbarem Premiumlevel. Einfach, spontan, ohne Limits, so ist das Leben mit Edgy.



Collection **Edgy**



L 107 li Edgy ▶ 390 cm ▼ 215 cm ▲ 72 cm
Stoff · Fabric · Tissu **65 9687 / 63 1584**



Q 107 li Edgy ▶ 297 cm ▼ 175 cm ▲ 72 cm
Stoff · Fabric · Tissu **64 1985**

Elemental freedom

Edgy celebrates the desire to design. The most modular Sofa in the collection came from the aspiration to combine flexibility, comfort and simplicity. Inspired by the game Tetris from the 80s, Edgy is based on a system of cuboids, which can be rearranged and combined by your heart's desire. With its functionality and its clear form language and the ability to immediately adapt to new situations, Edgy welcomes the urban lifestyle. Rounded edges and a thought-out upholstery bring comfort on a premium level. Easy, spontaneous and without limits: That's what life with Edgy looks like.



Z 107 li Edgy ▶ 310 cm ▼ 215 cm ▲ 72 cm
Stoff · Fabric · Tissu **61 9487 / 63 1584**

Facts & Highlights

- Super flexibel, weil das Leben nie stillsteht: Modulares System beruhend auf einem 40 cm Raster mit 4 Modultiefen: 82 / 122 / 162 / 202 cm, 4 Sitztiefen: 62 / 102 / 142 / 182 cm und 4 Modulbreiten: 82 / 122 / 162 / 202 cm
- Nachträglich veränderbar durch ab- und/oder ummontieren der Lehnenelemente
- Fest montierbare Lehnen sowie flexible Auflagerollen mit Roll-back-Effekt
- Spannender Materialmix von Sitz zu Rücken möglich für noch mehr gestalterische Freiheit
- Super flexible because life never stands still: modular system based on a 40 cm grid, with 4 module depths of: 82 / 122 / 162 / 202 cm, 4 seat depths 62 / 102 / 142 / 182 cm and 4 module widths of: 82 / 122 / 162 / 202 cm
- Suitable for subsequent changes due to arm/backrests which can be taken off and/or repositioned
- Arm/backrests can be installed firmly, flexible support rollers with "rollback effect" exist as well
- Exciting mixture of materials in between seat and backrest possible – for even more creative freedom
- Ultra-flexible, parce que la vie est toujours en mouvement : système modulaire basé sur une trame de 40 cm avec 4 profondeurs de module : 82 / 122 / 162 / 202 cm, profondeurs de d'assise 62 / 102 / 142 / 182 cm et 4 largeurs de module : 82 / 122 / 162 / 202 cm
- Modifications ultérieures possibles grâce à la capacité à démonter et changer les éléments d'appui
- Appuis fixes et rouleaux de surface flexibles avec effet Rollback
- Possibilité de mélange parfait de matériaux de l'assise au dossier pour une liberté créatrice encore décuplée

Collection **Edgy**

La liberté élémentaire

Edgy célèbre le plaisir d'aménager. Le canapé le plus modulables de la collection est né de la volonté de réunir flexibilité, confort et simplicité. Inspiré du jeu Tetris des années 1980, le système repose sur des carrés qui peuvent être réorganisés et combinés à volonté. Avec sa posture fonctionnelle, le langage clair des formes et la capacité de s'adapter à toutes les situations, Edgy adopte un style de vie très urbain. Des angles arrondis et un rembourrage bien réfléchi garantissent un confort de premier choix. Simple, spontanée et sans limites, c'est la vie avec Edgy.



F 107 Edgy ▶ 270 cm ▼ 135 cm ▲ 72 cm
Stoff · Fabric · Tissu **61 9426 / 63 1524**



Collection **Edgy**



F 107 Edgy ▶270 cm ▼135 cm ▲72 cm
Stoff · Fabric · Tissu **61 9426 / 63 1524**

C 107 D Edgy ▶122 cm ▼82 cm ▲40 cm
Stoff · Fabric · Tissu **61 9426**



Z 107 li Edgy ▶310 cm ▼215 cm ▲72 cm
Stoff · Fabric · Tissu **61 9426 / 63 1524**

Collection **Edgy**



U-TN-RK-RE 107 Edgy ▶297 cm ▼135 cm ▲72 cm
Stoff · Fabric · Tissu 64 1922 / 65 0322



Y 107 re Edgy ▶297 cm ▼215 cm ▲72 cm
Stoff · Fabric · Tissu 64 1922 / 65 0322



Y 107 re Edgy ▶297 cm ▼215 cm ▲72 cm
Stoff · Fabric · Tissu 64 1922 / 65 0322

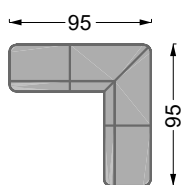

SNE

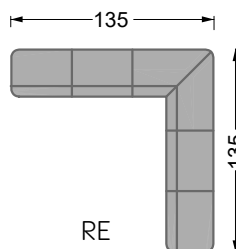

RE

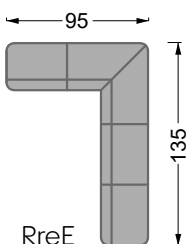

RreE

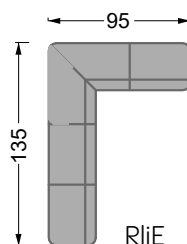

RliE

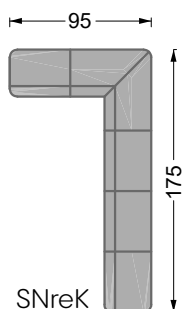

SNreK

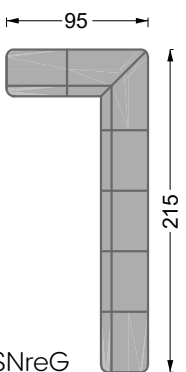

SNreG

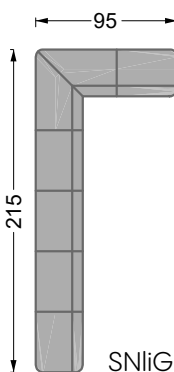

SNIiG

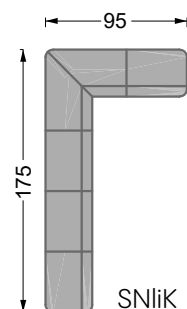

SNliK

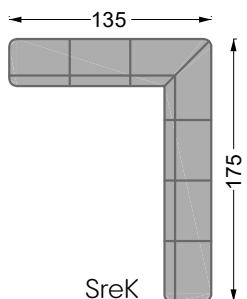

SreK

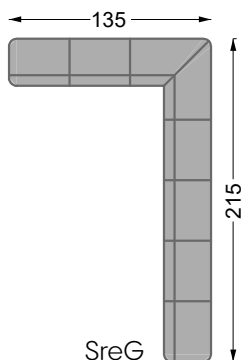

SreG

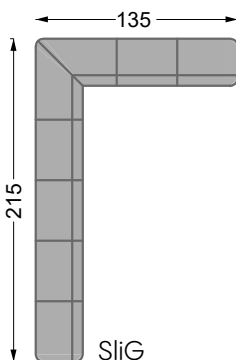

SliG

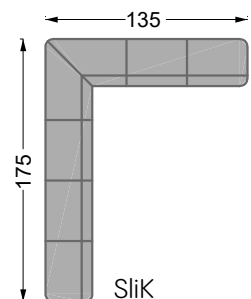

SliK

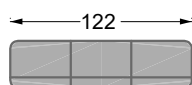

RK

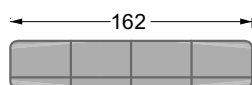

RM

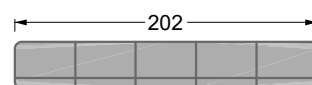

RG

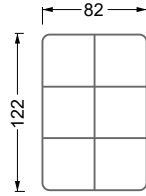

PS

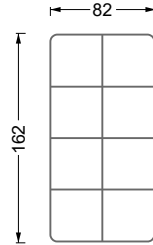

TE

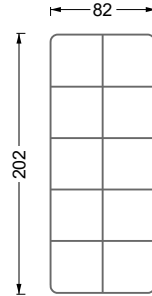

TDE

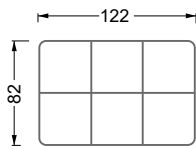

TNS

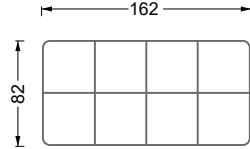

UN

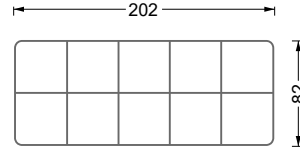

VN

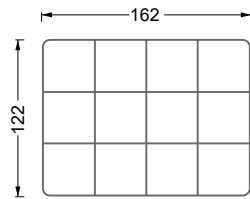

U

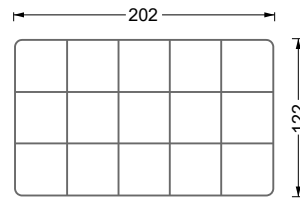

V

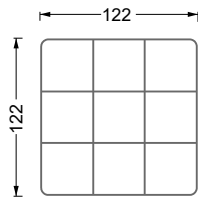

TN

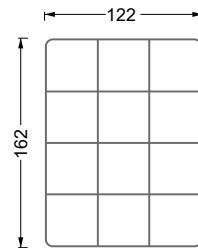

T

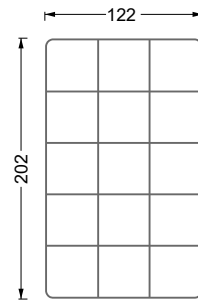

TD

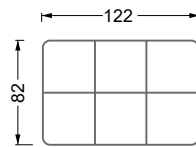

CD

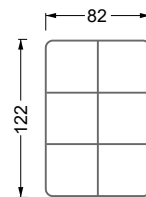

CE

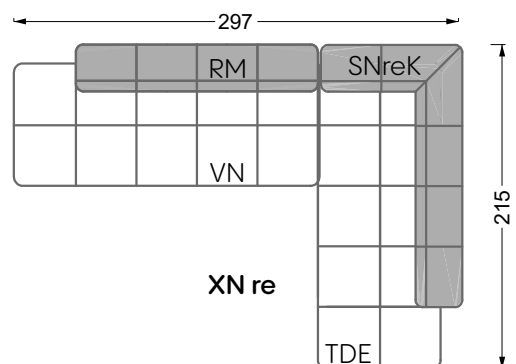
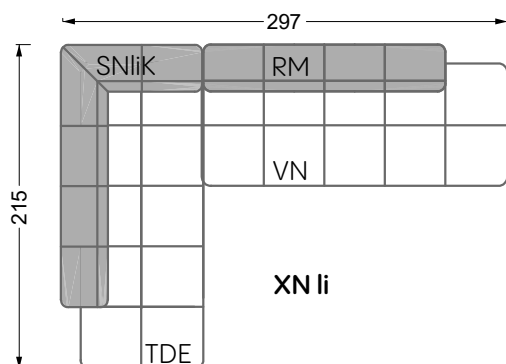
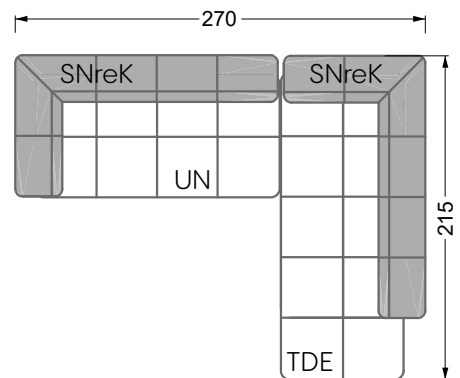
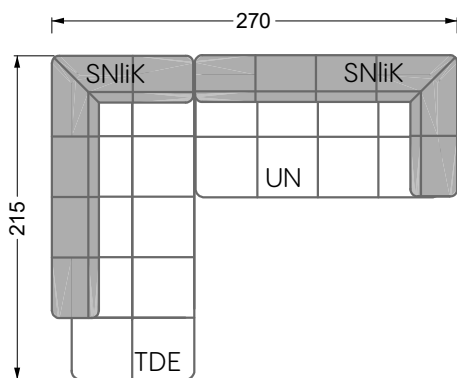
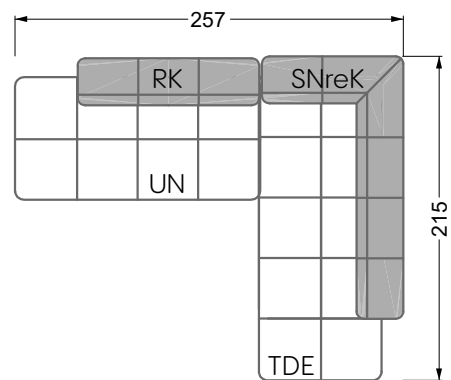
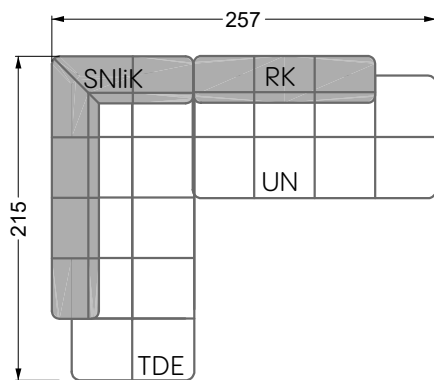
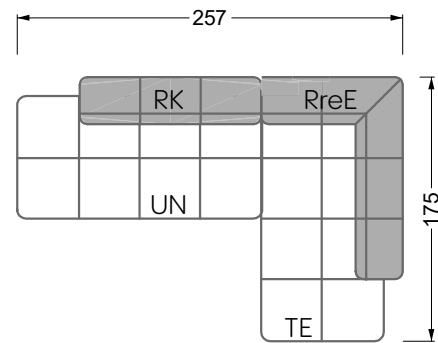
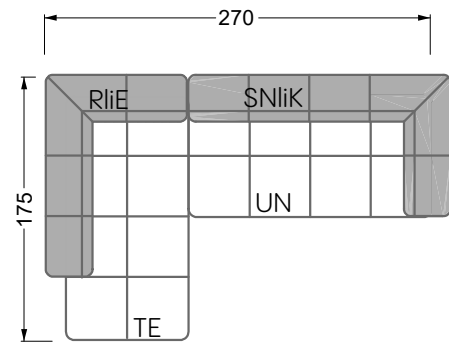
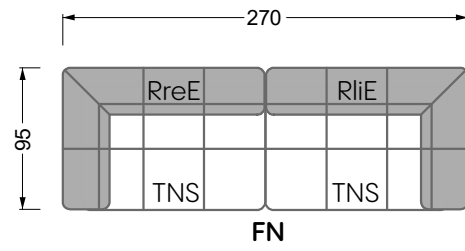
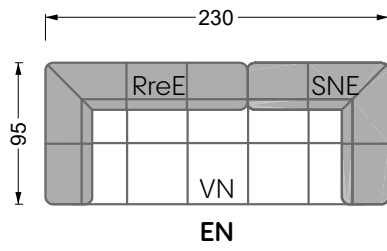

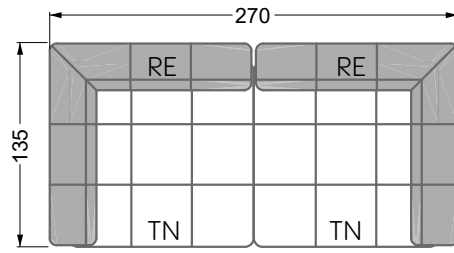

F

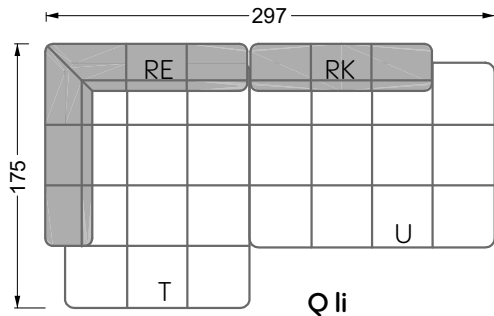

Q li

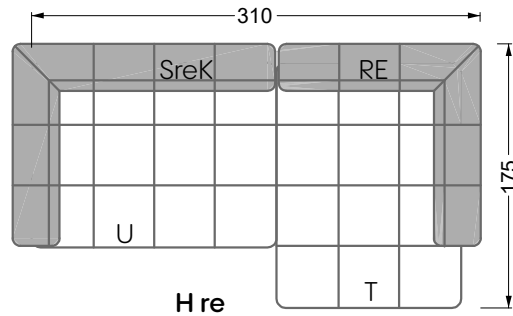

H re

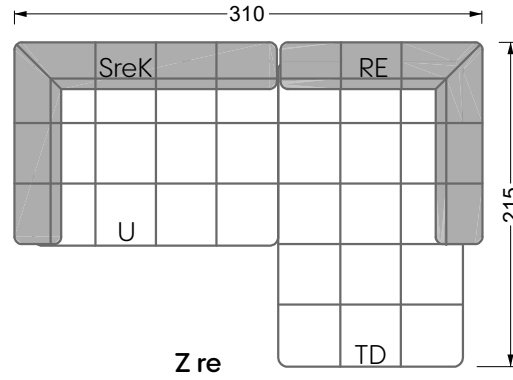
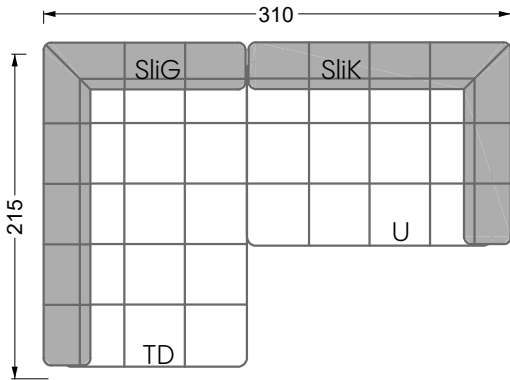

Z re

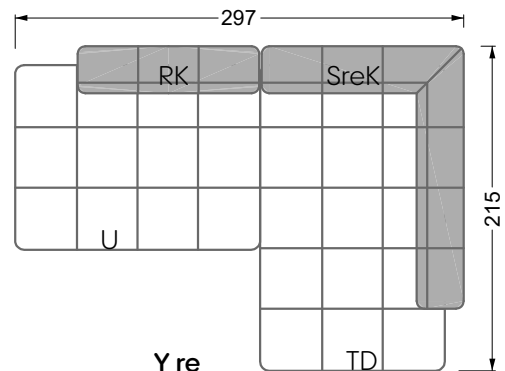
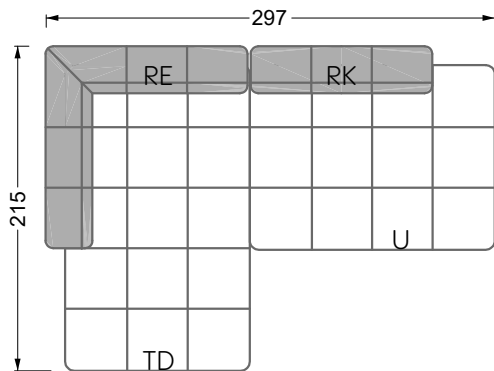

Y re

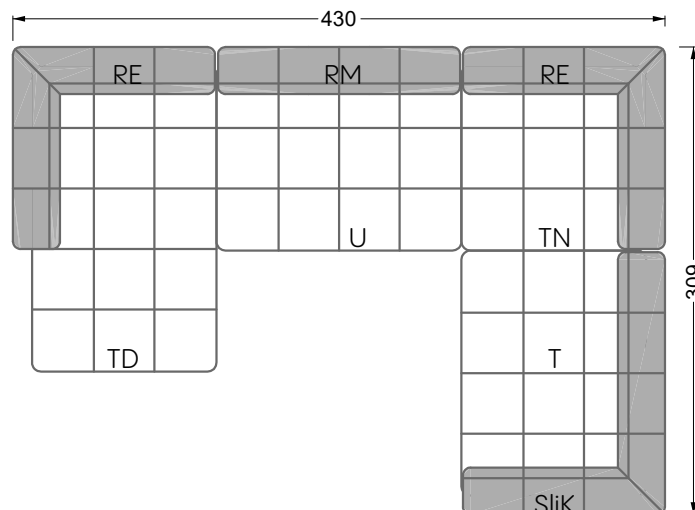

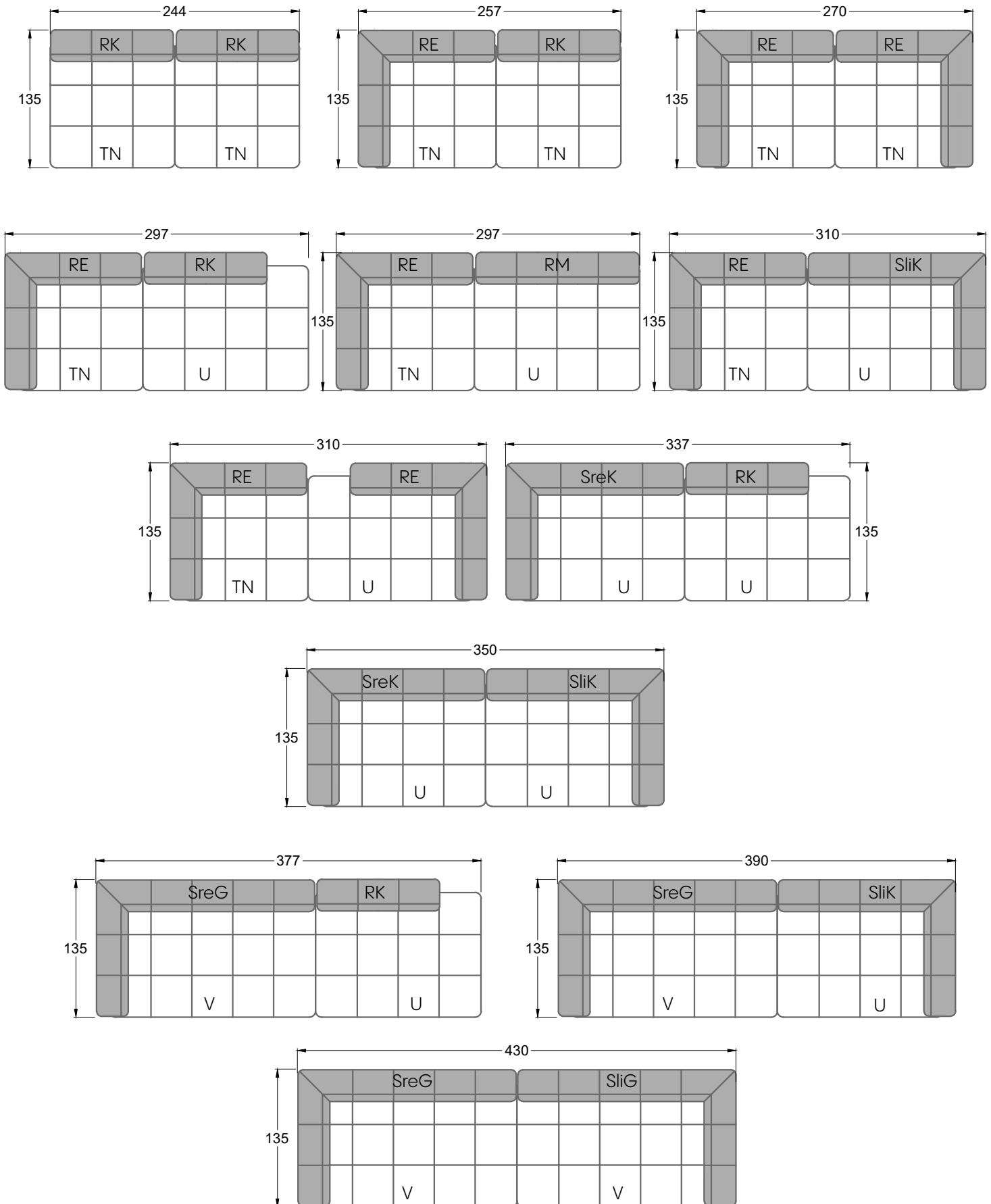

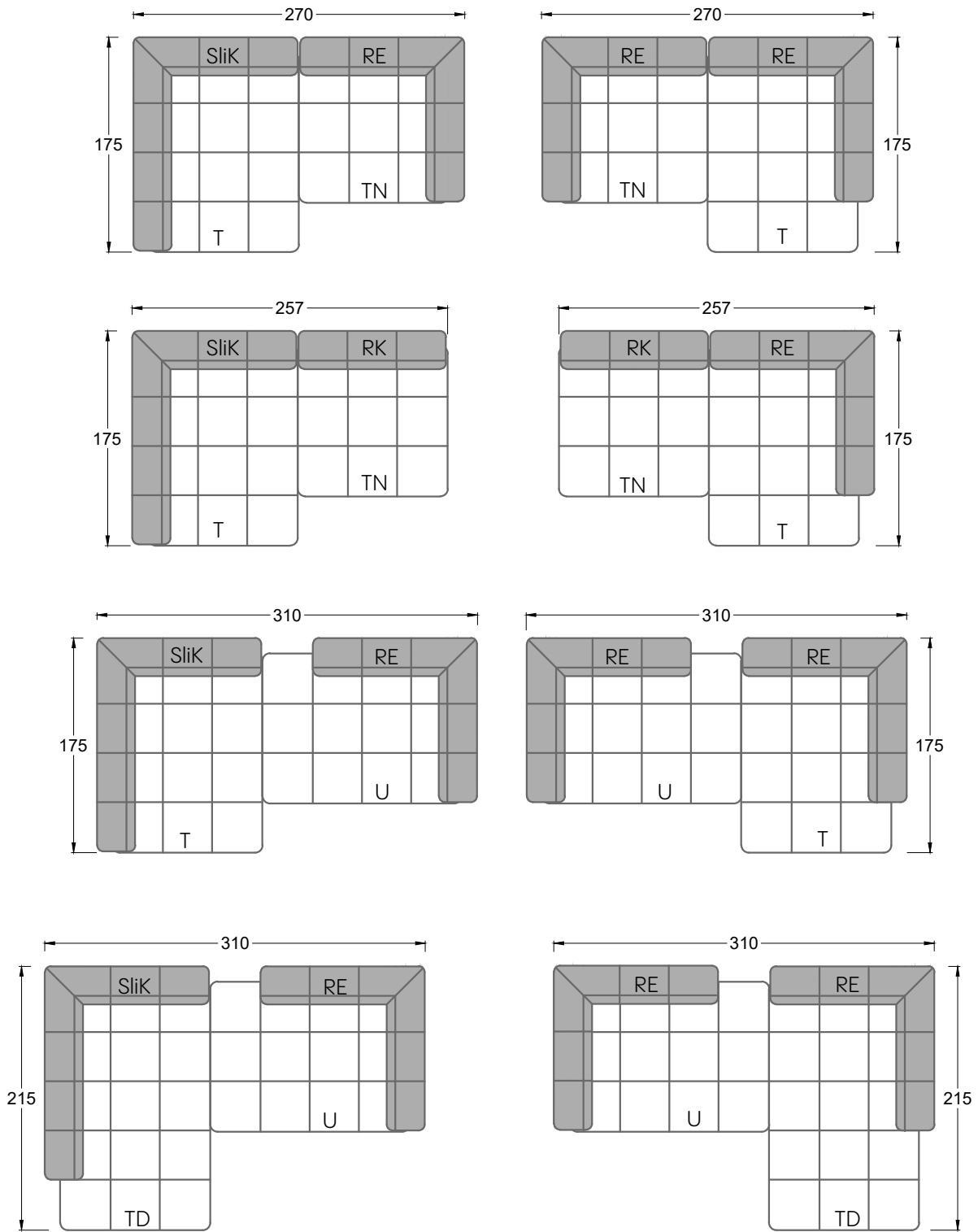

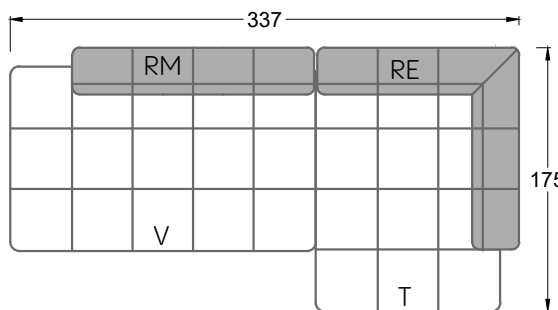
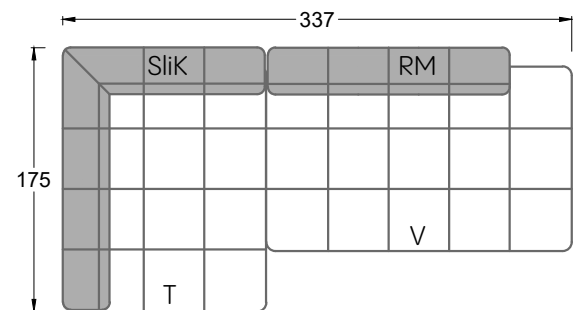
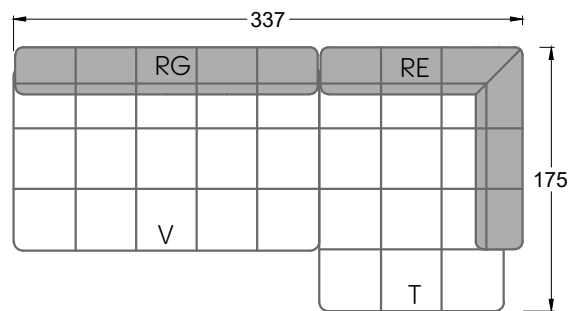
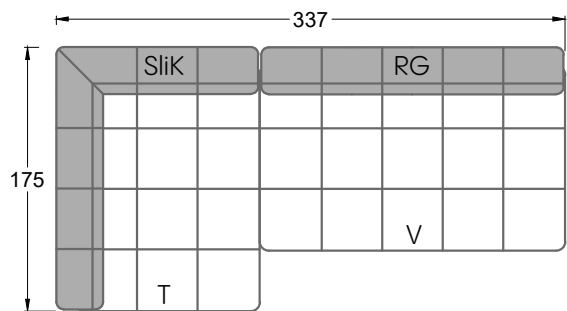
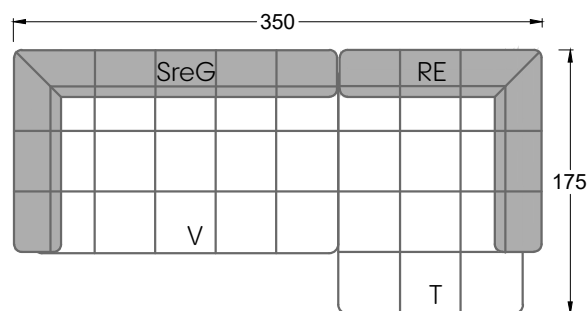
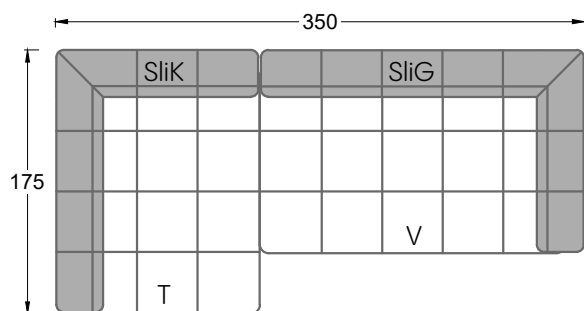
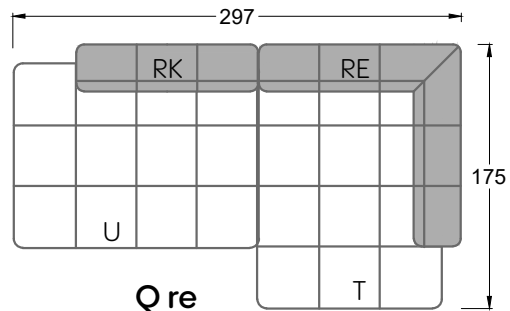
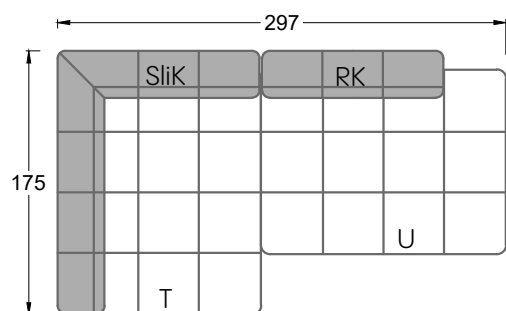
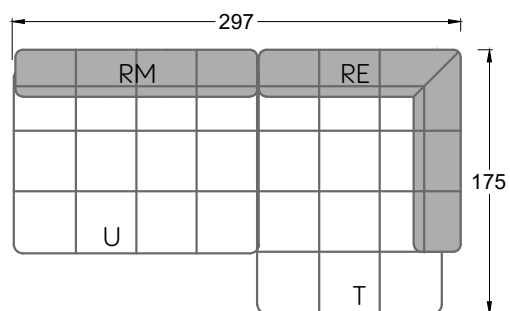
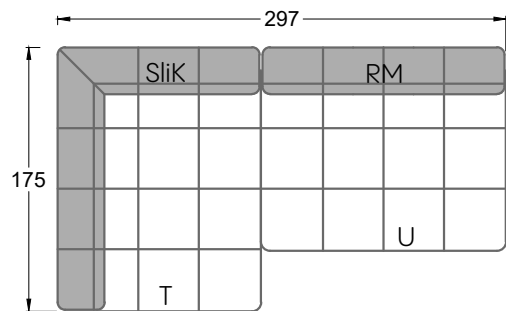
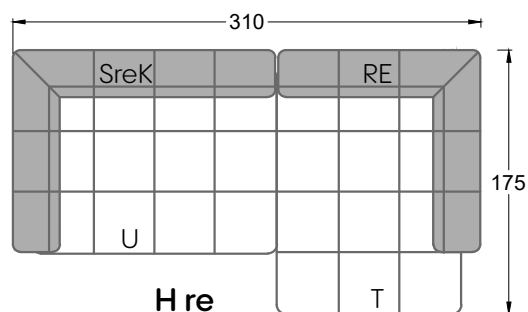
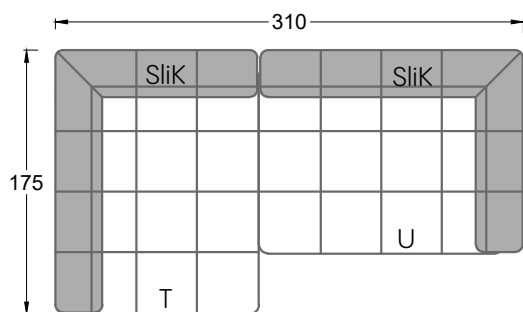

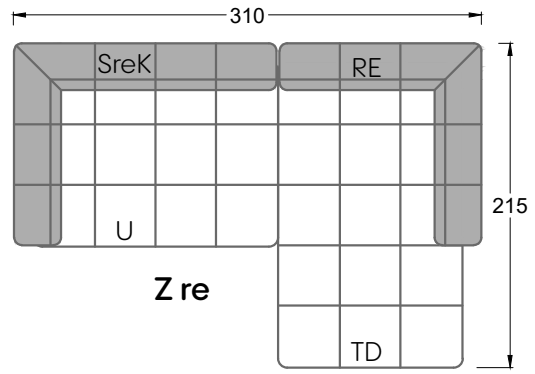
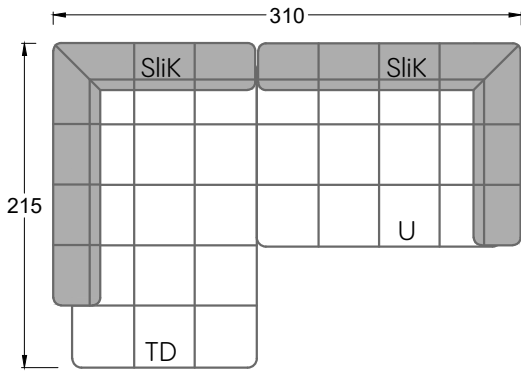

Z re

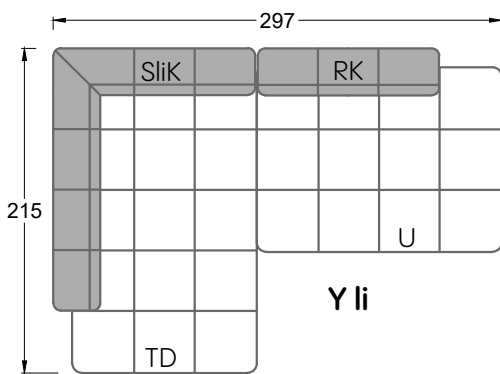
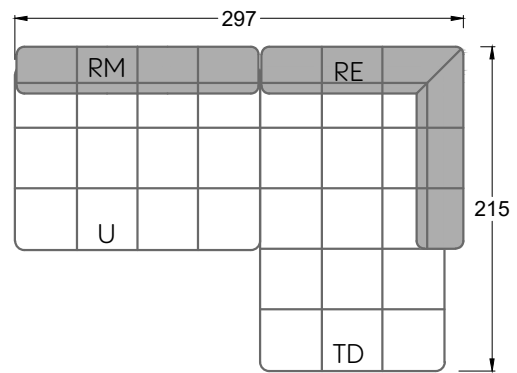
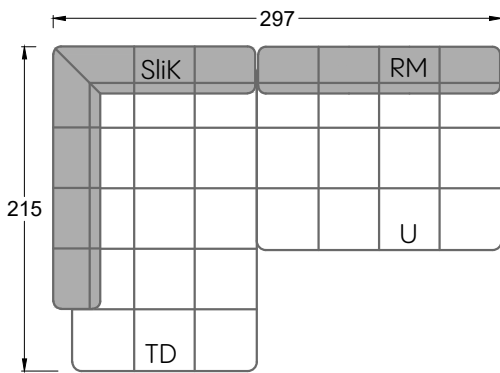

Y li

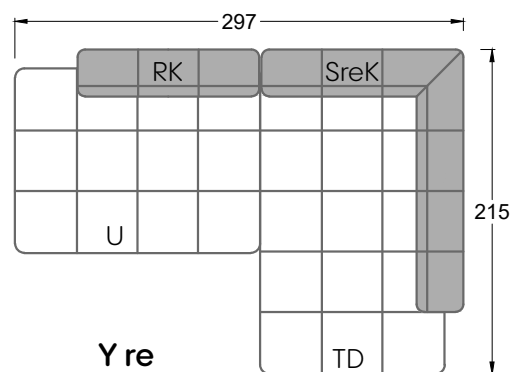
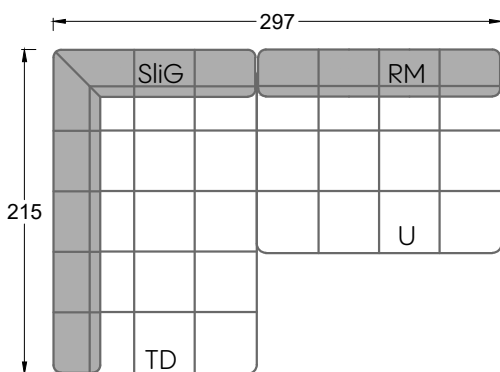
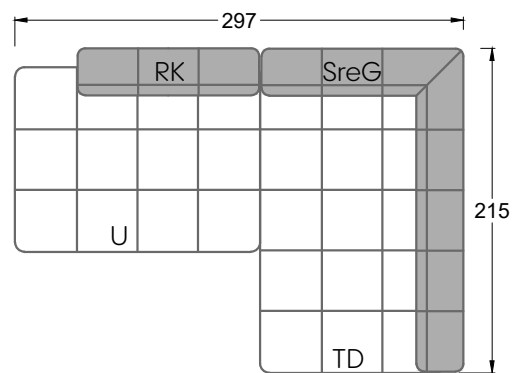
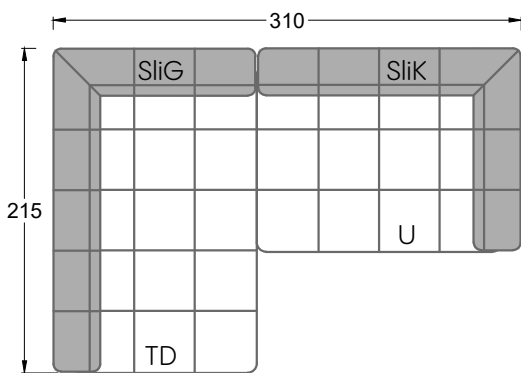
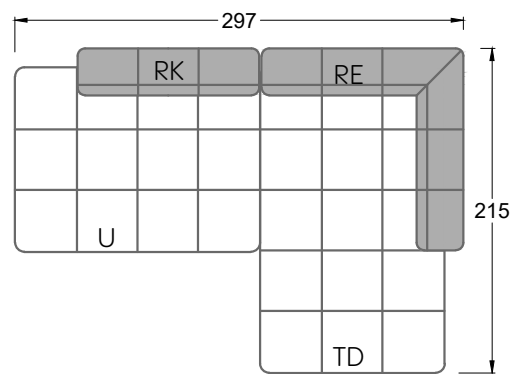

Y re

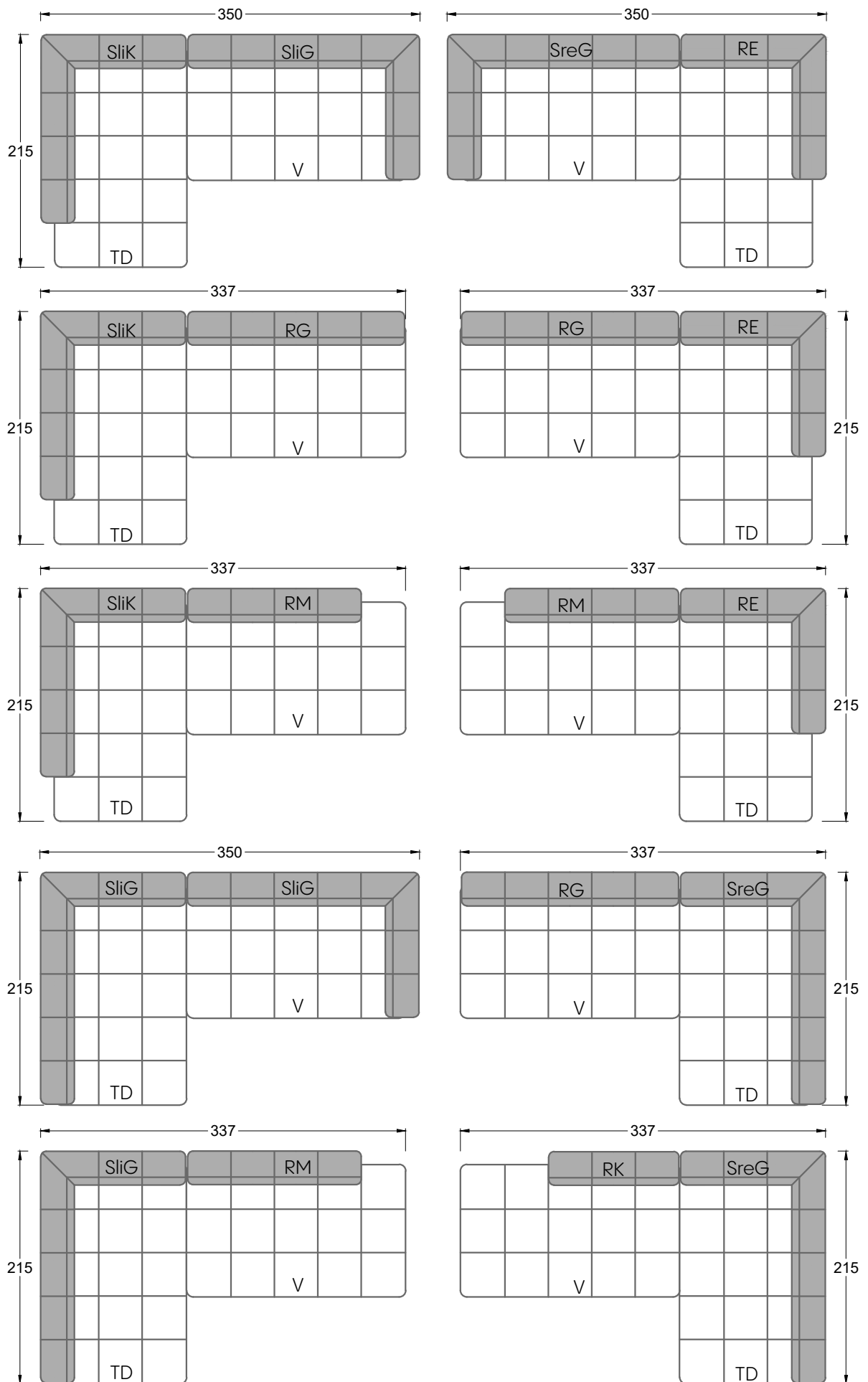

Edgy

107 • Ecksofas mit langer Récamière & loser Rolle

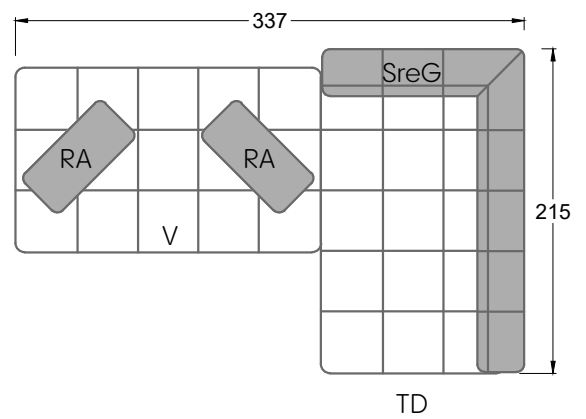
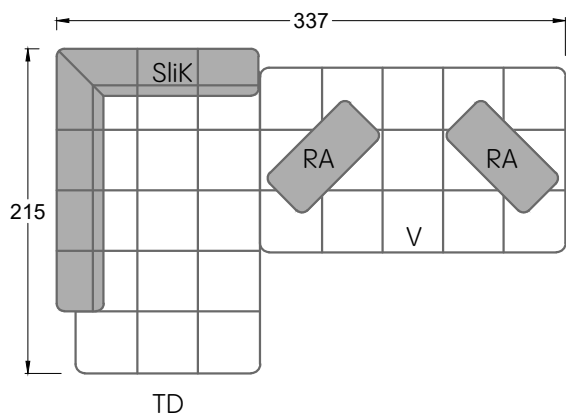
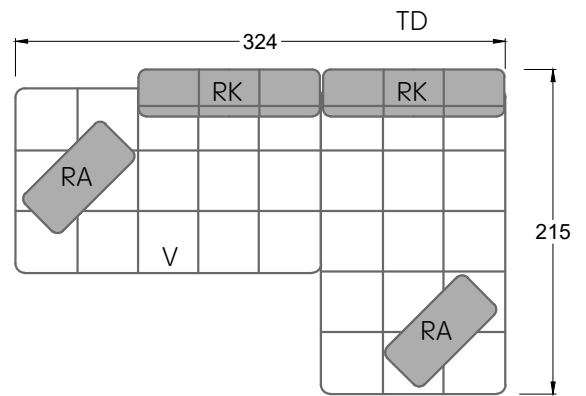
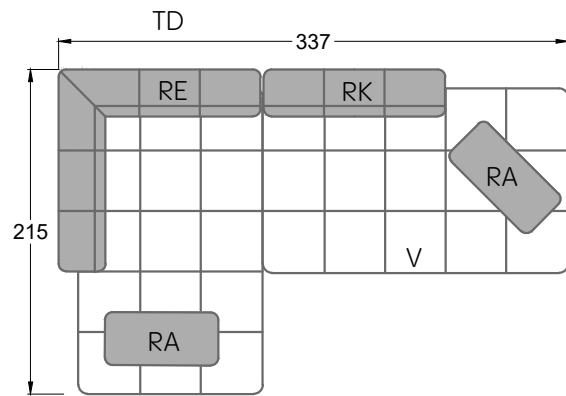
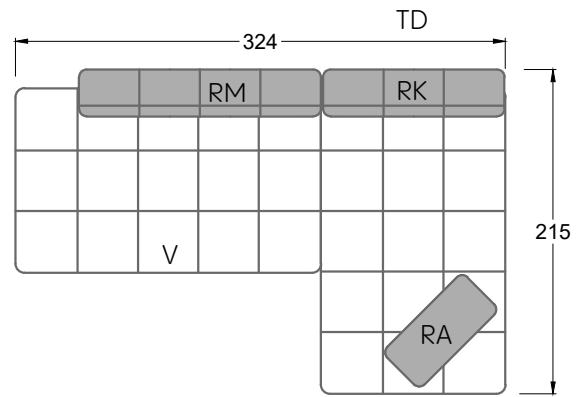
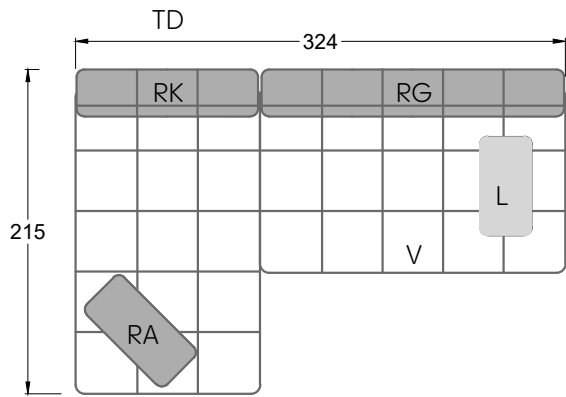
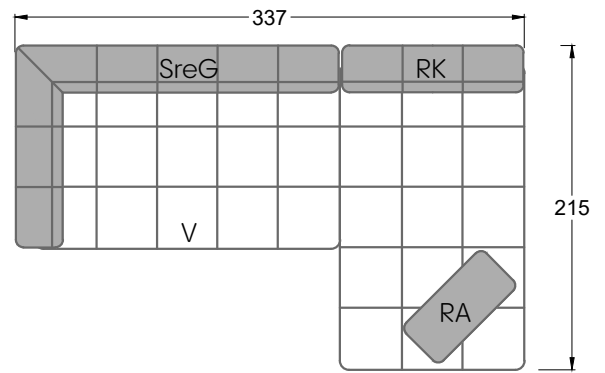
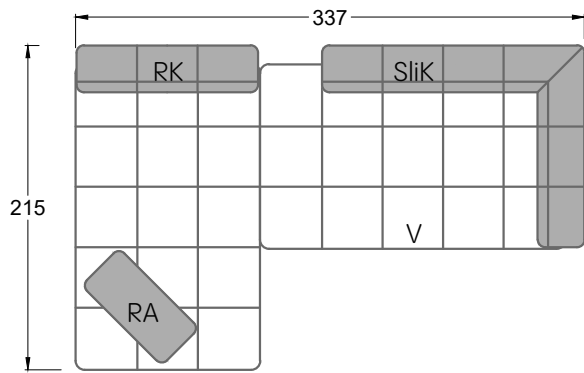

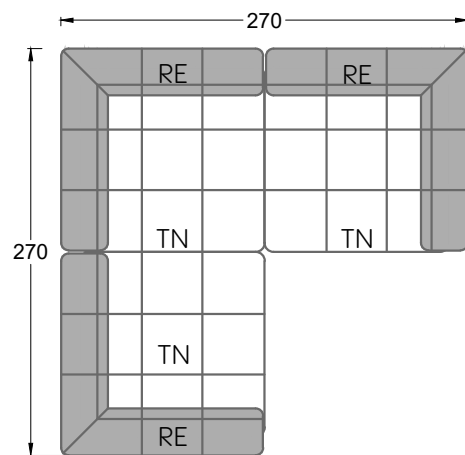
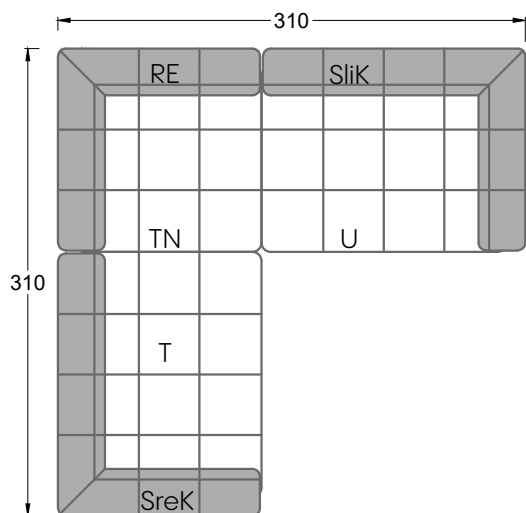
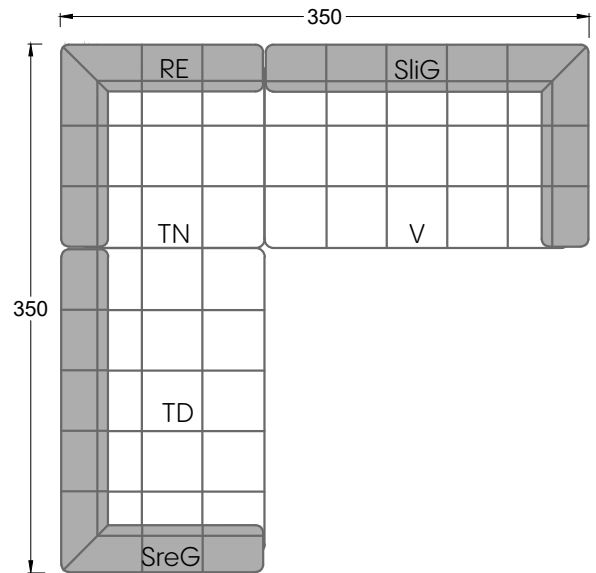
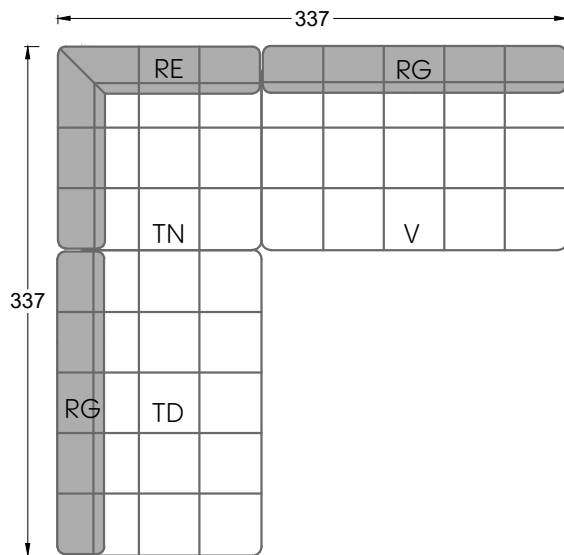
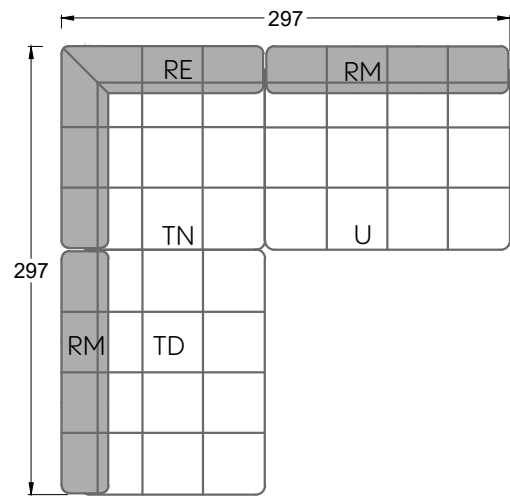
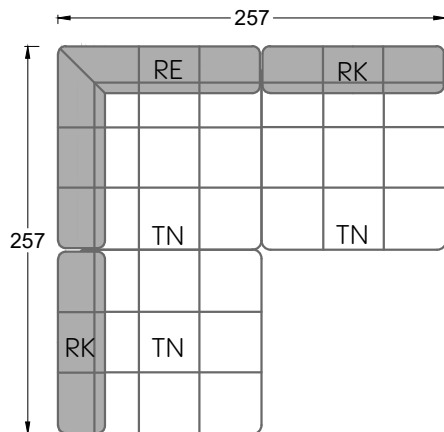

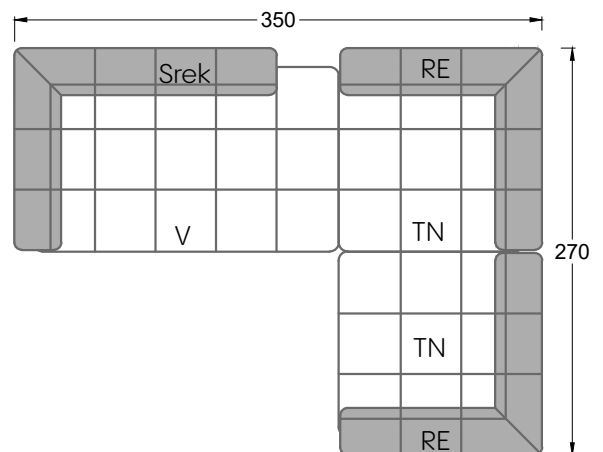
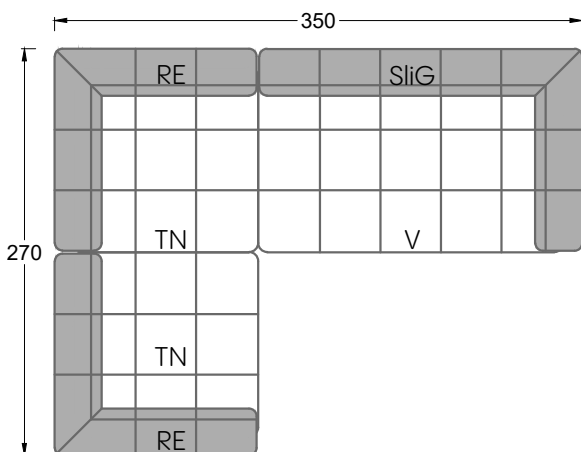
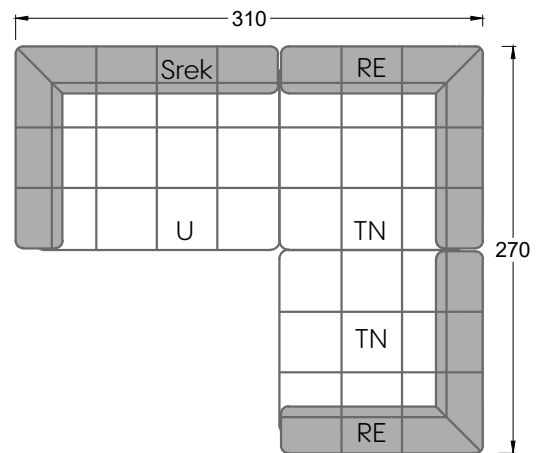
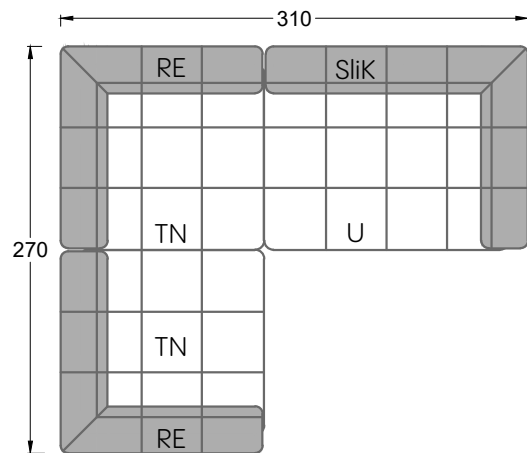
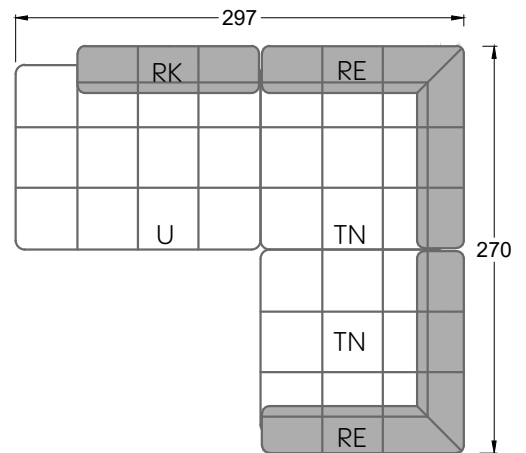
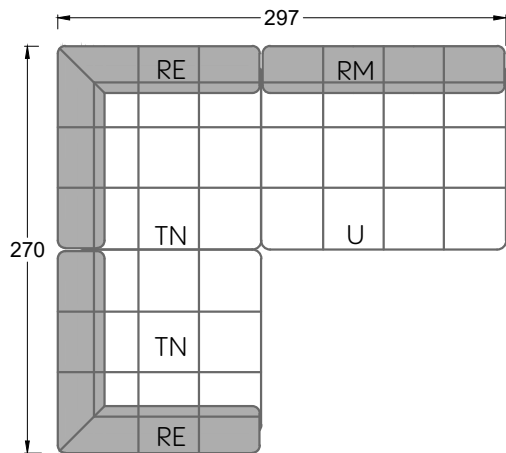
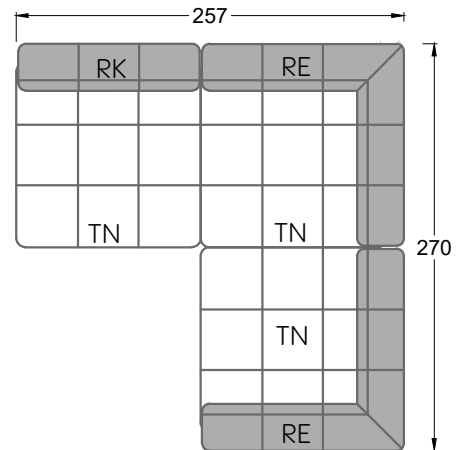
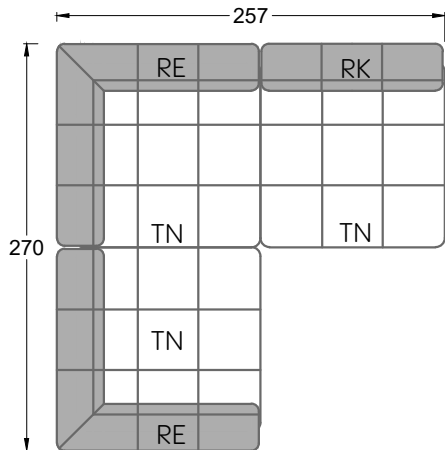

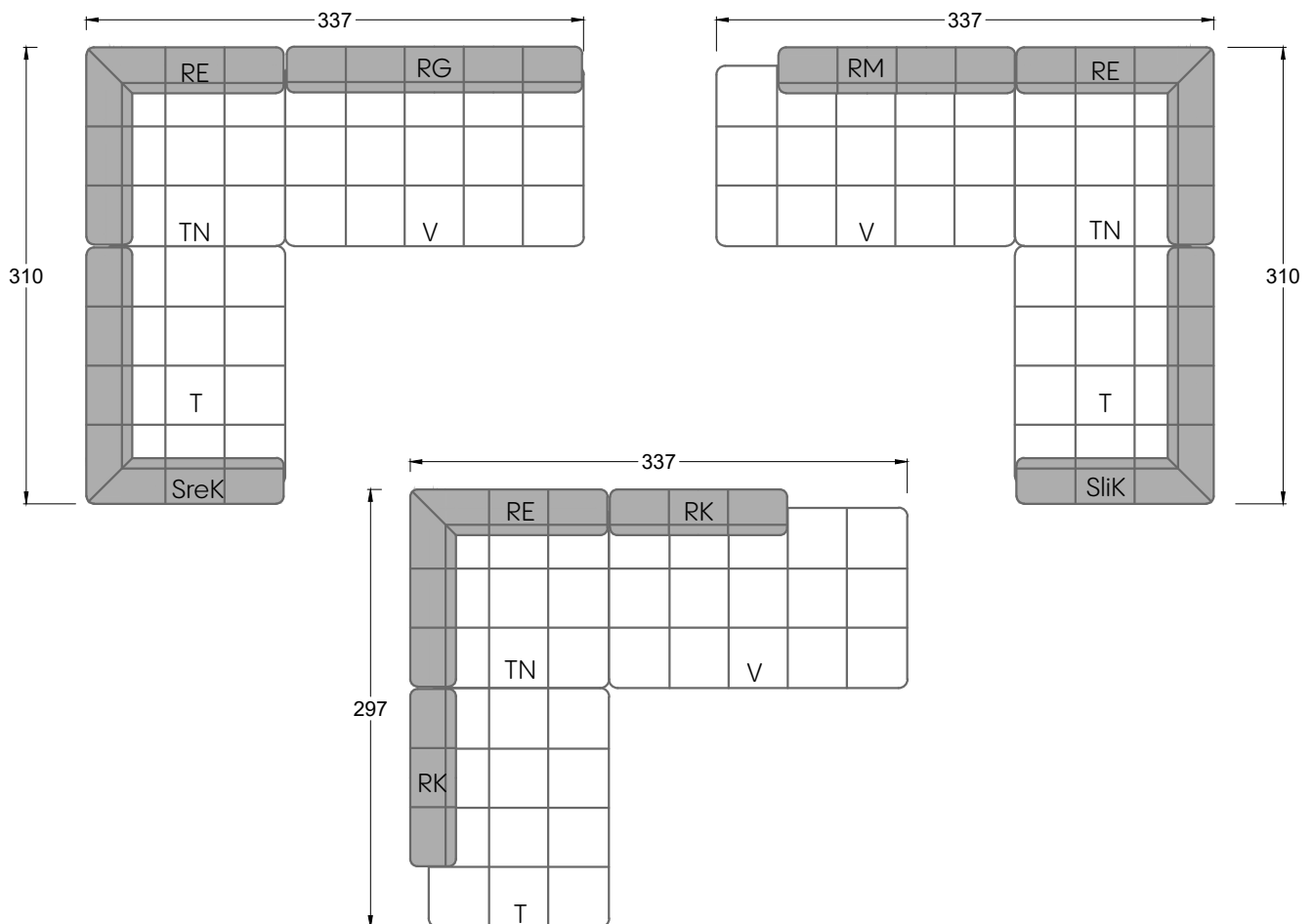
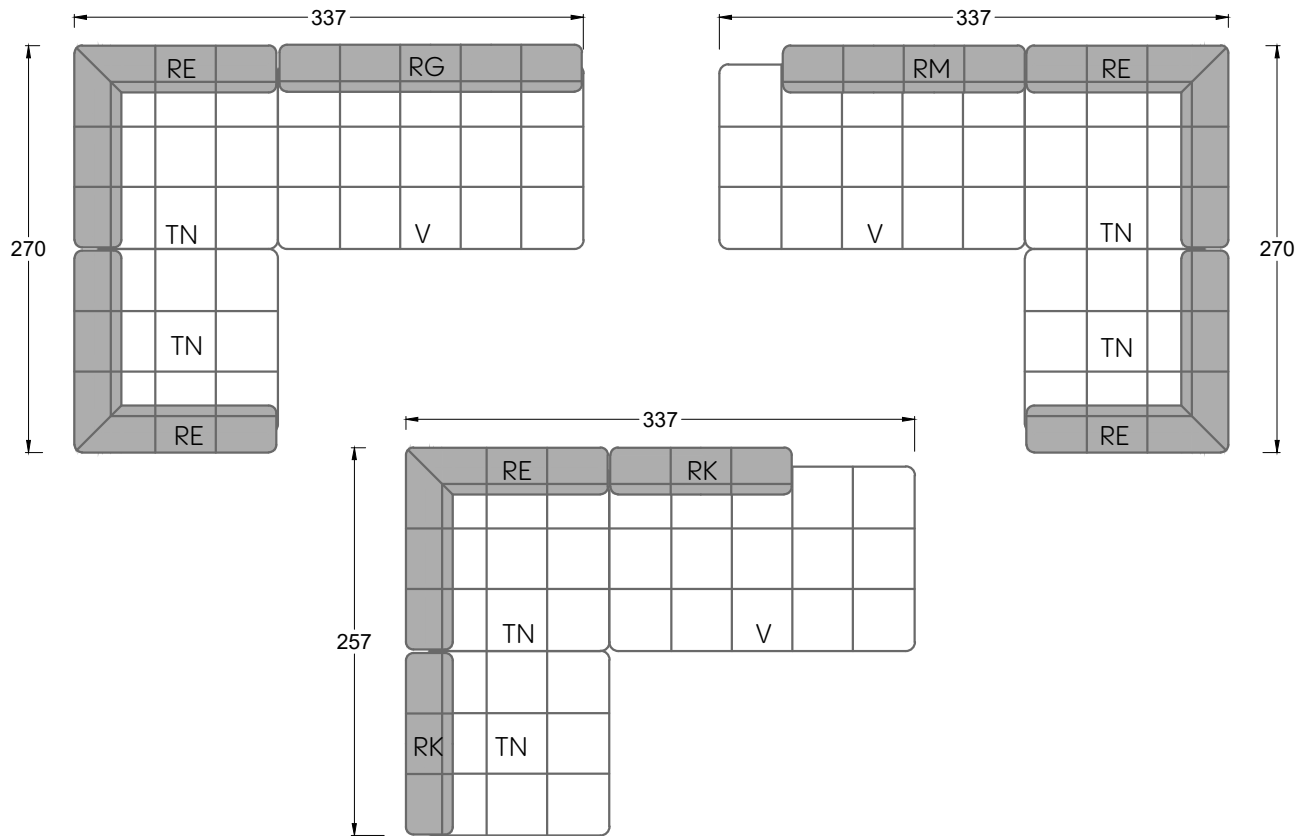

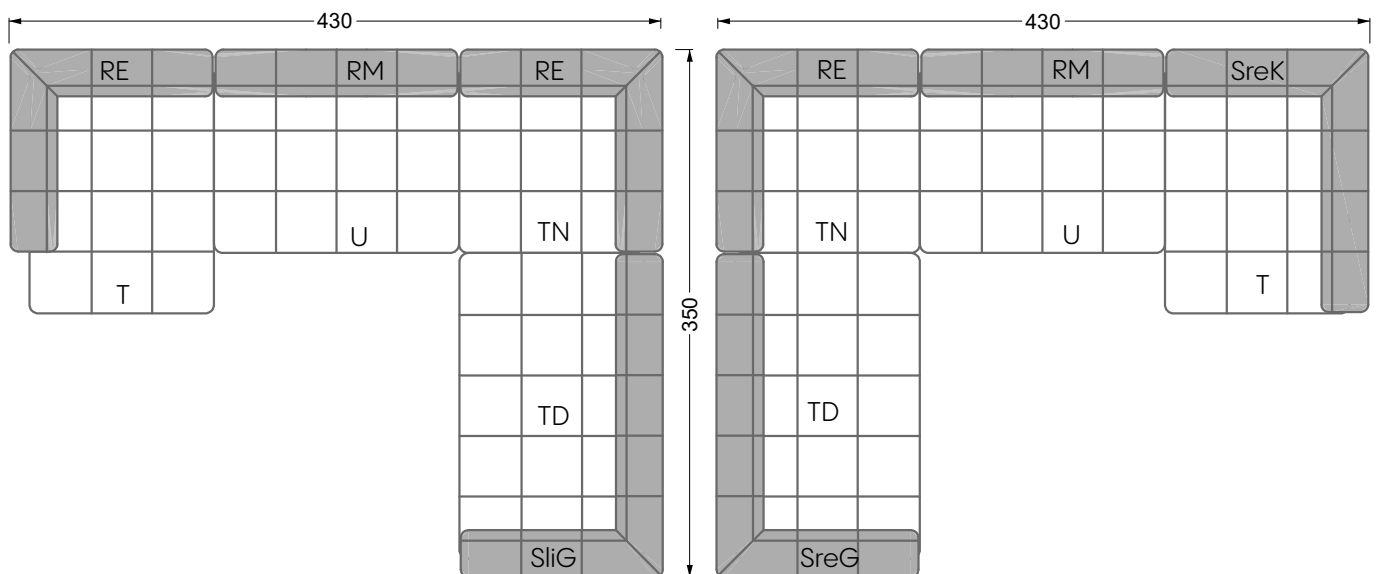
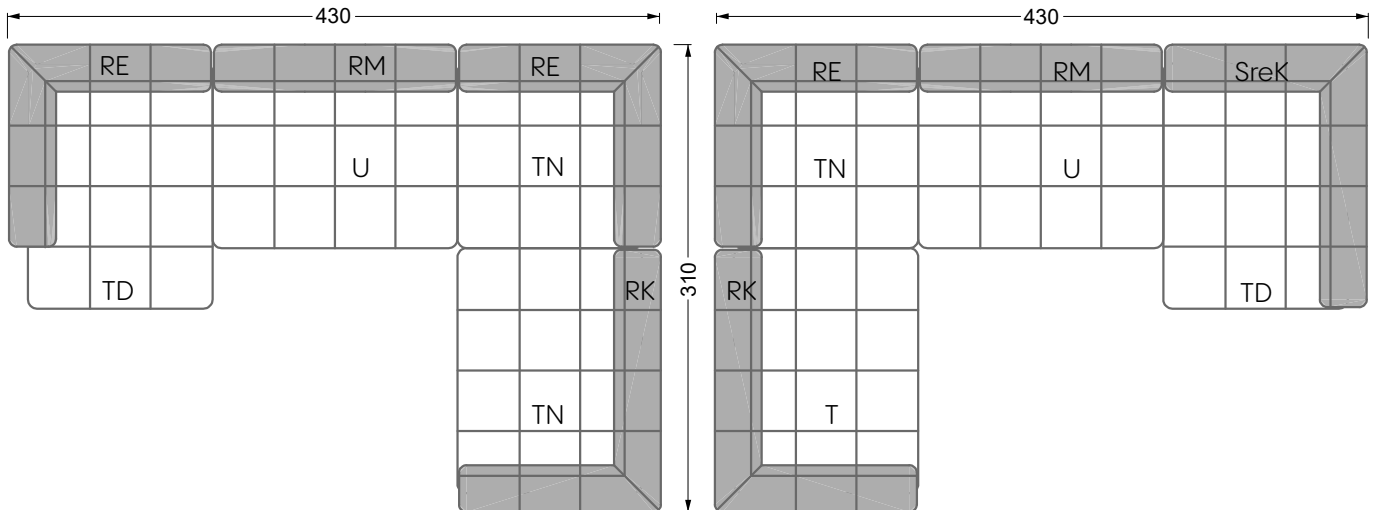
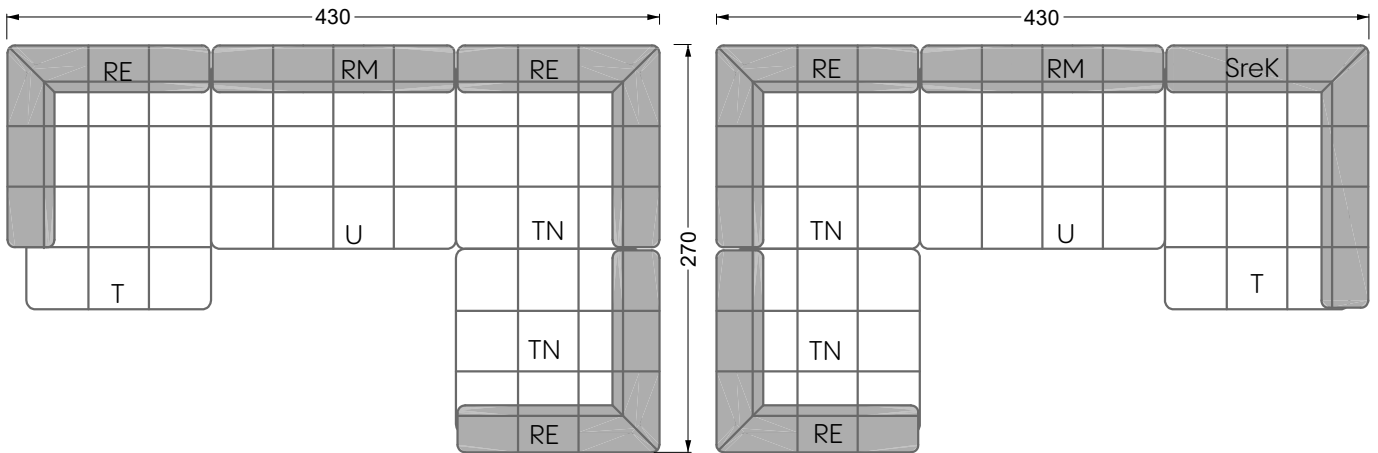

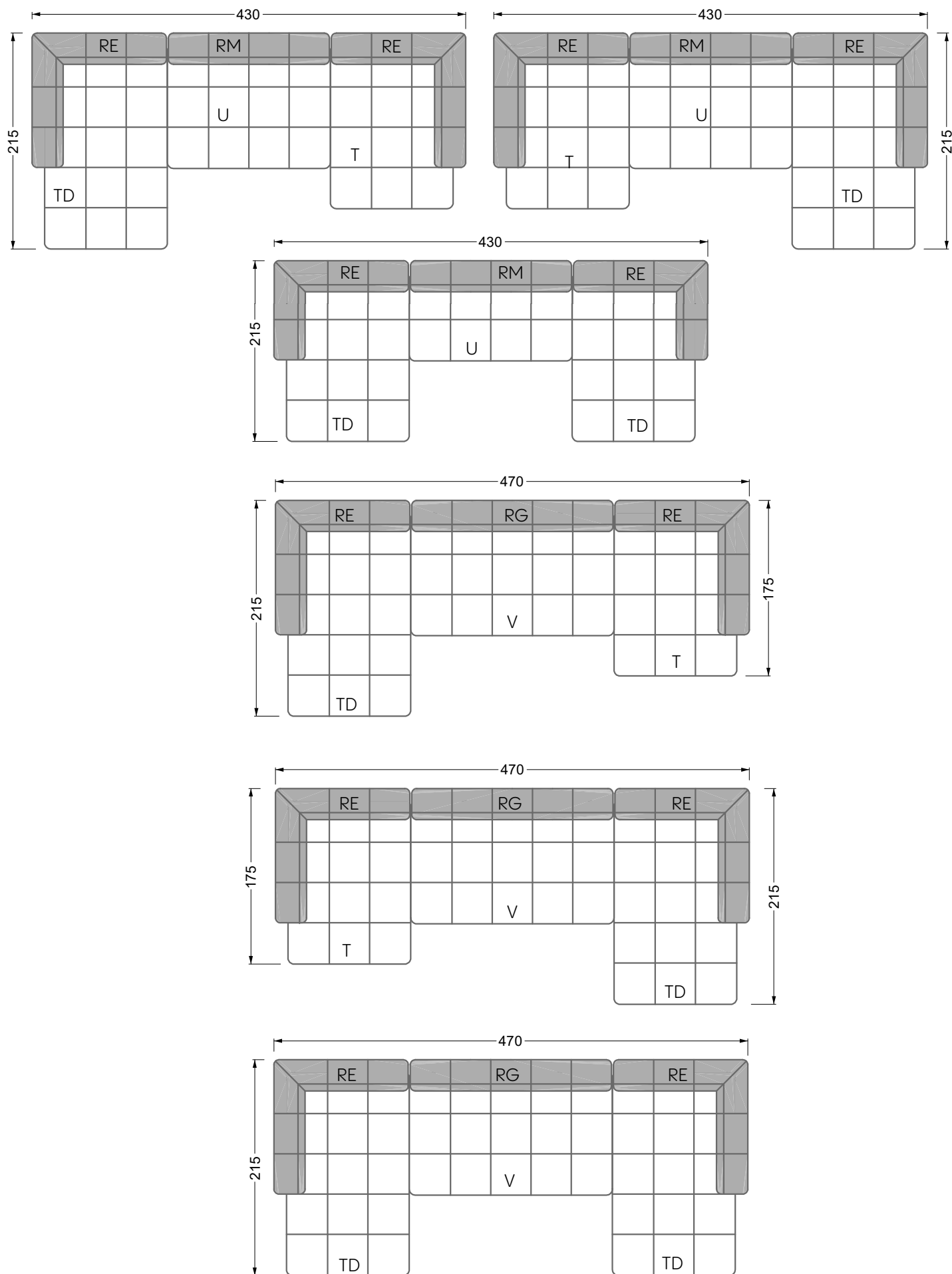

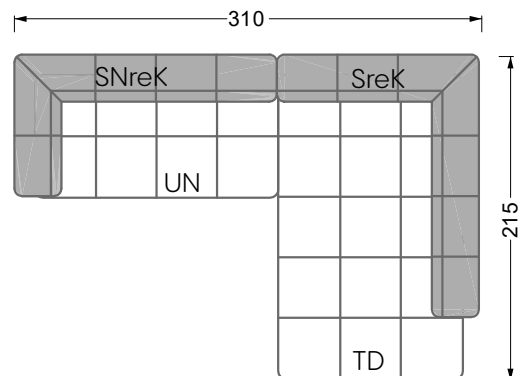
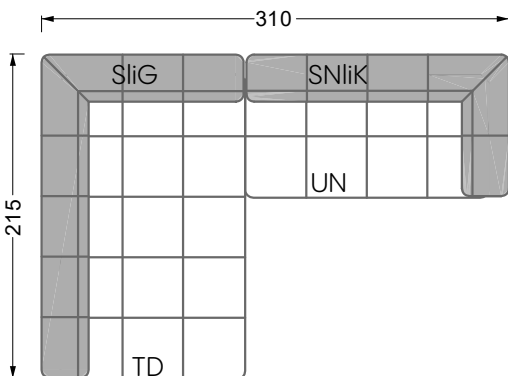
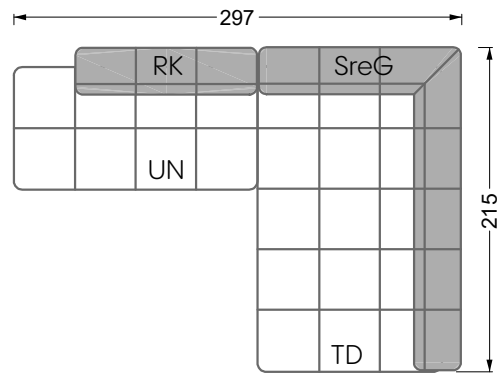
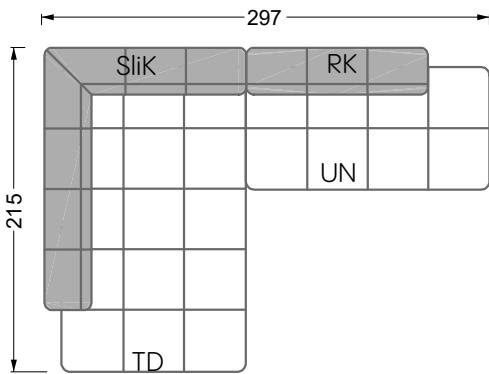
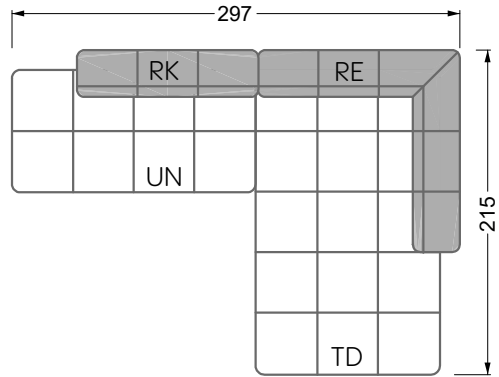
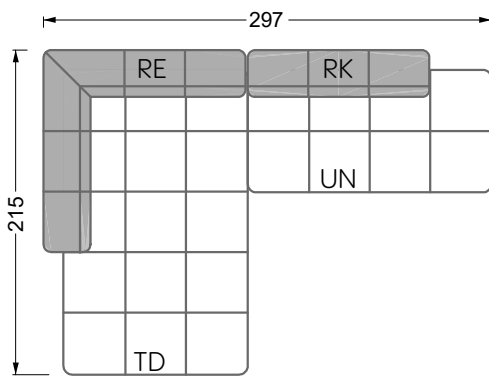
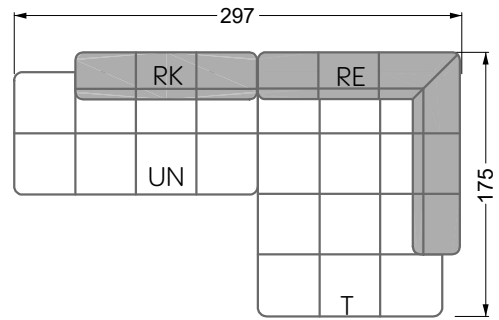
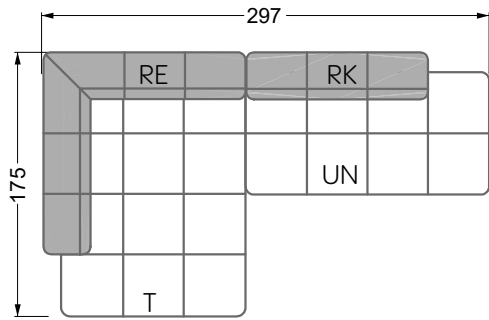
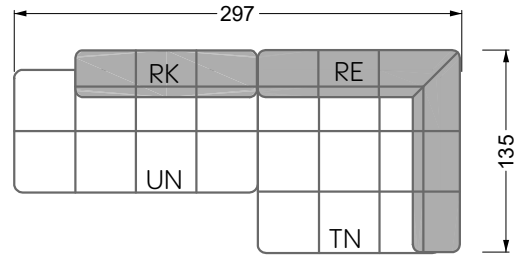
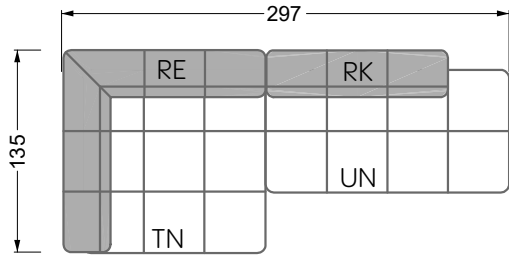

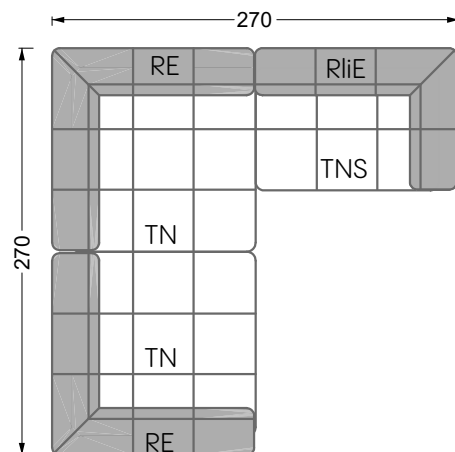
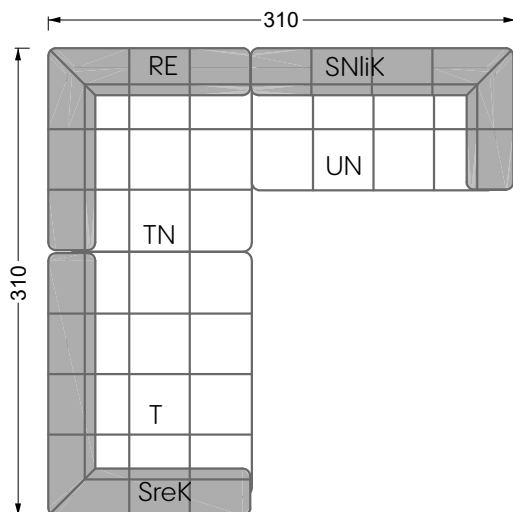
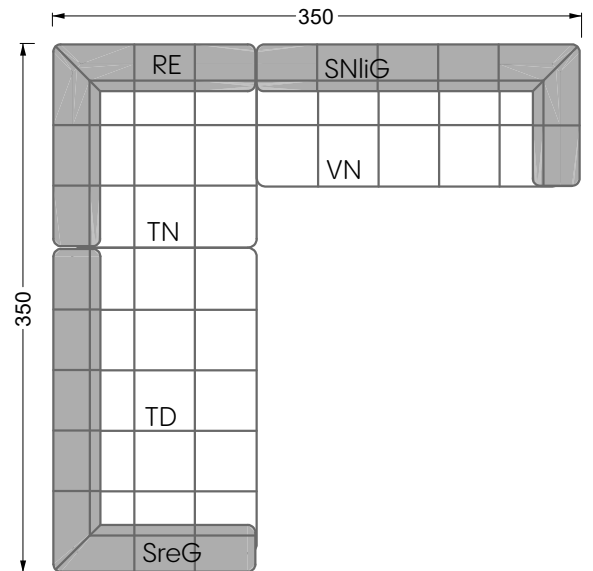
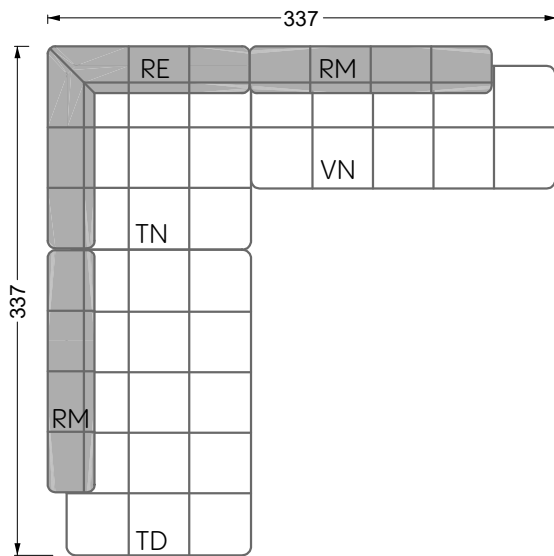
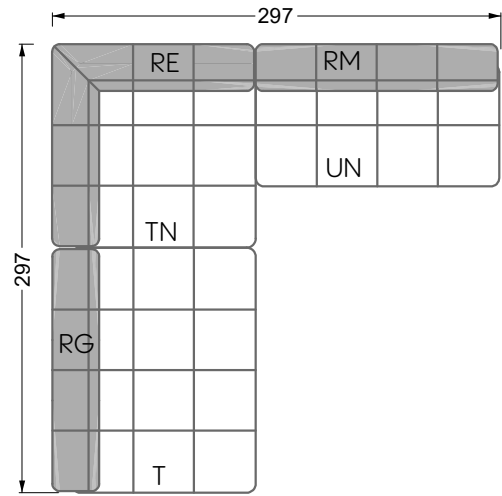
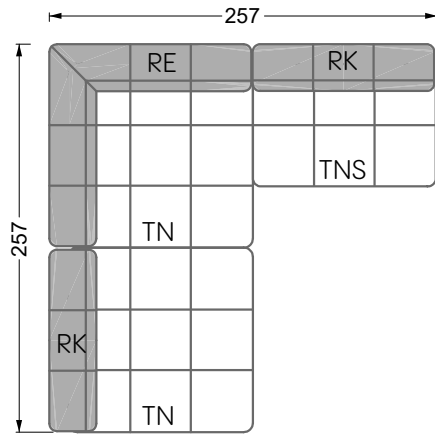

Edgy

107 • Ecksofas mit schmalen Elementen

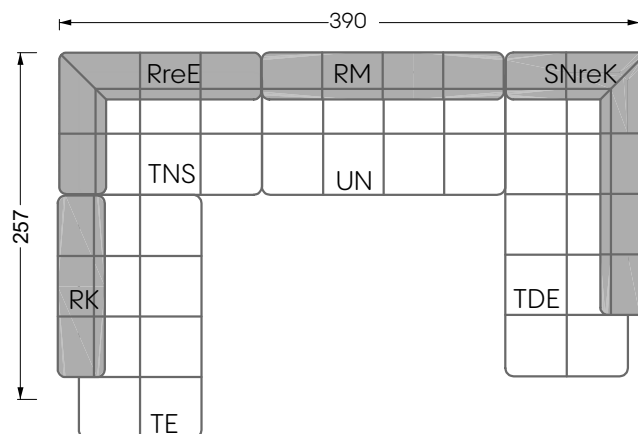
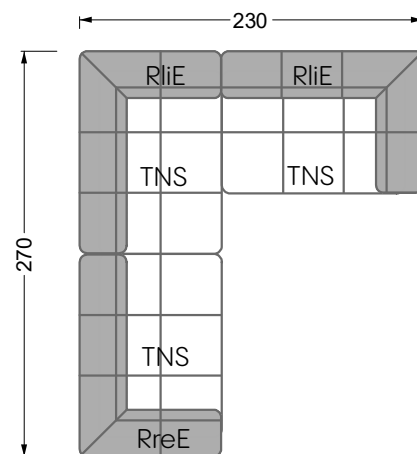
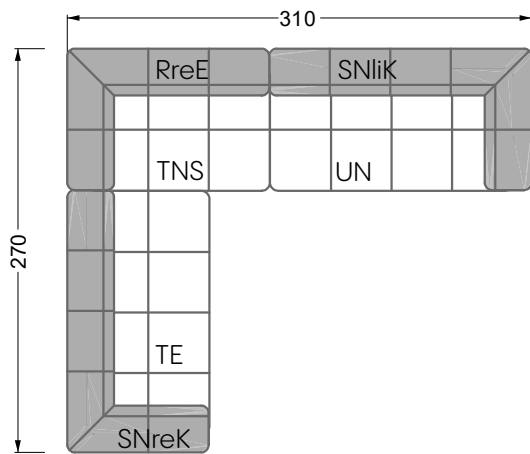
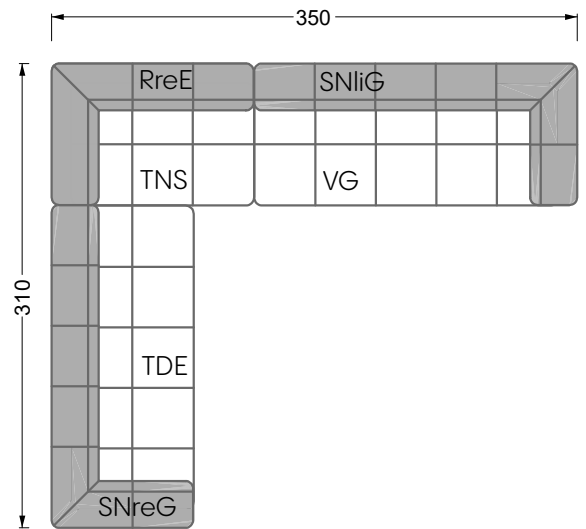
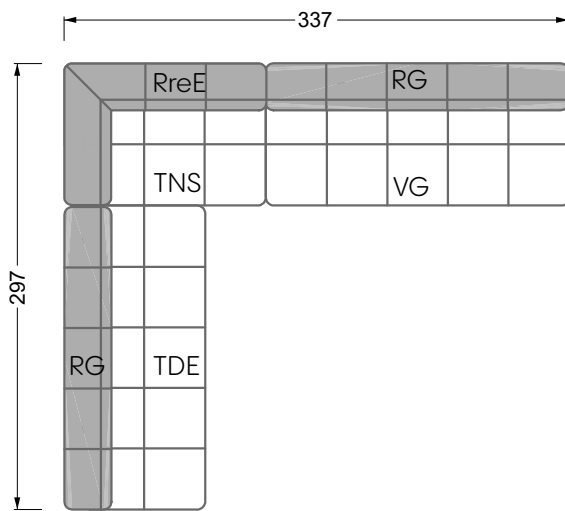
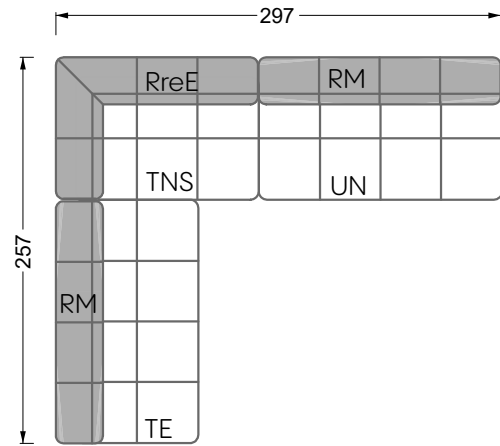
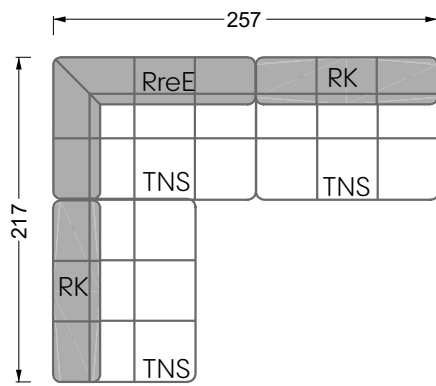

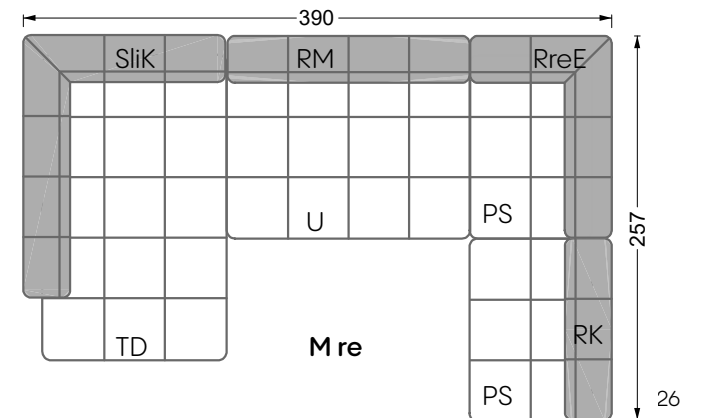
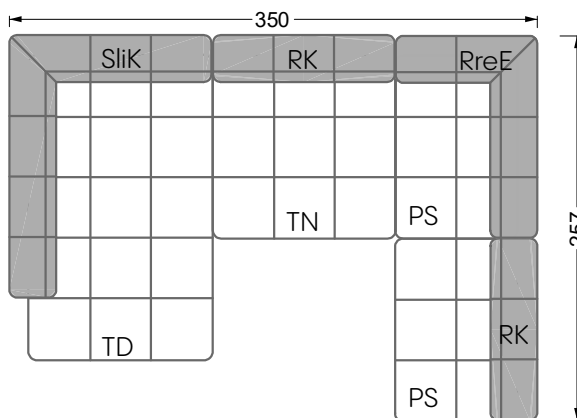
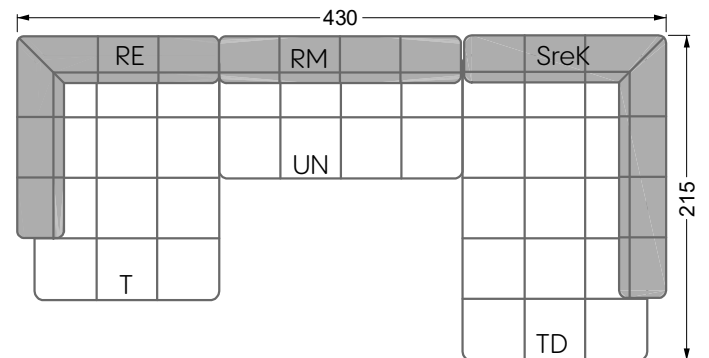
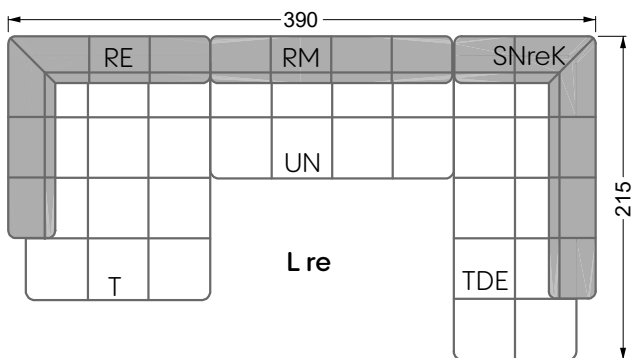
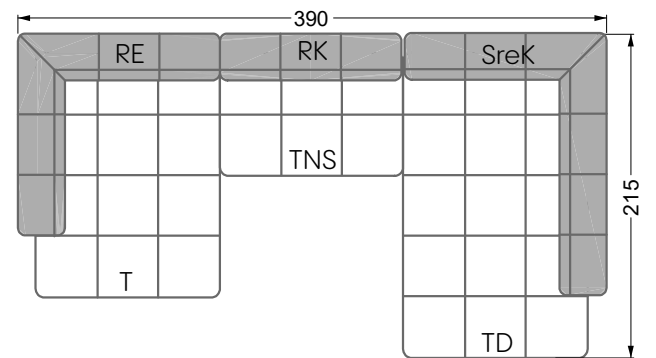
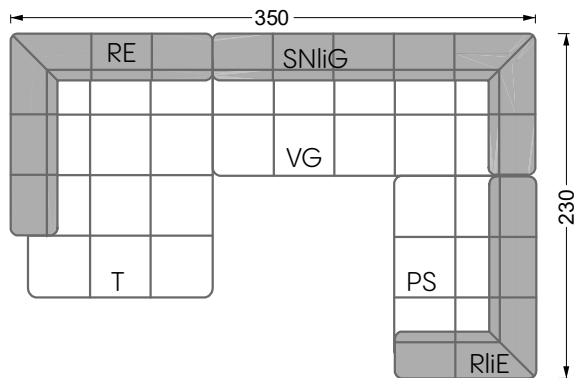
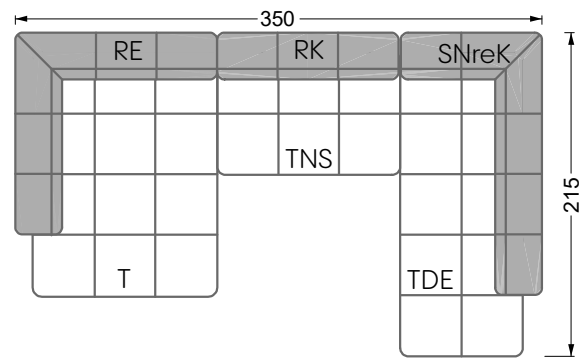
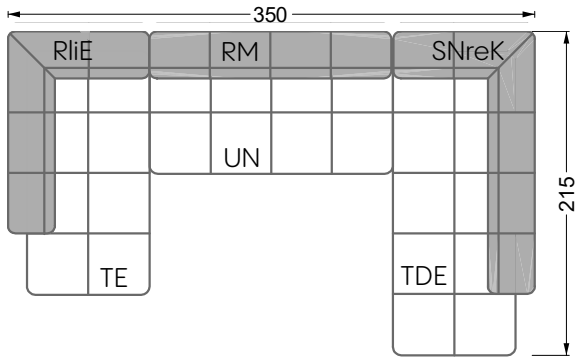
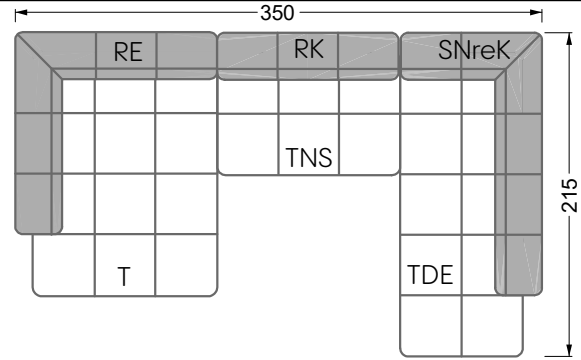
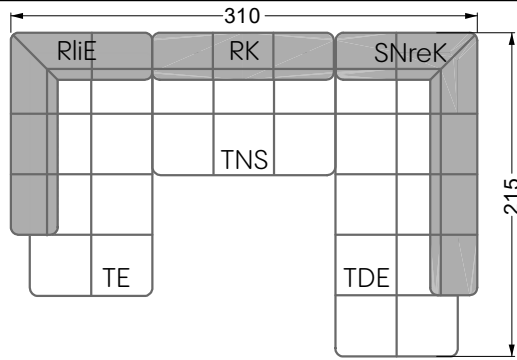

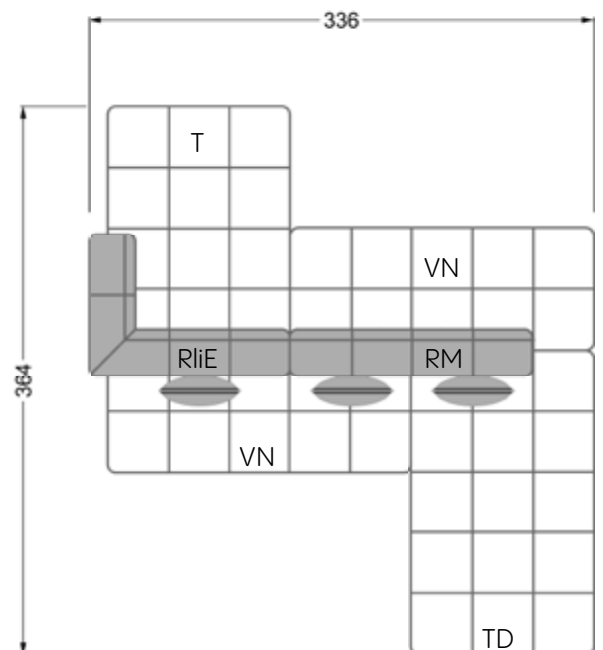
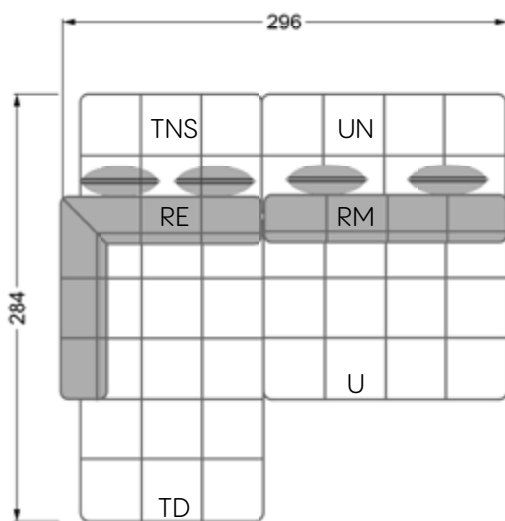
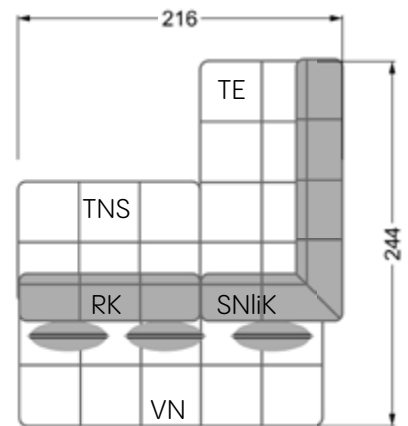
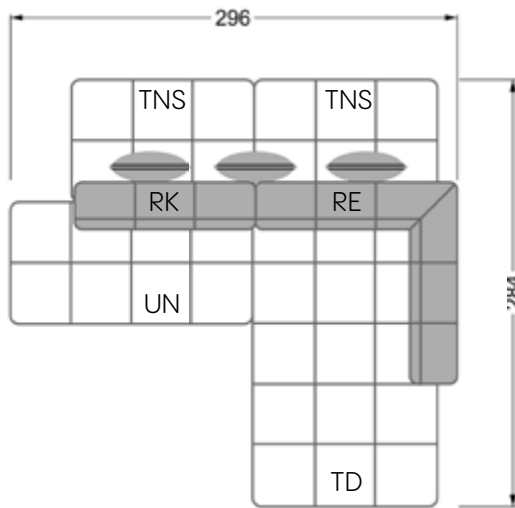
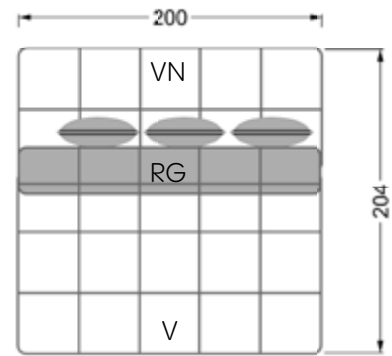
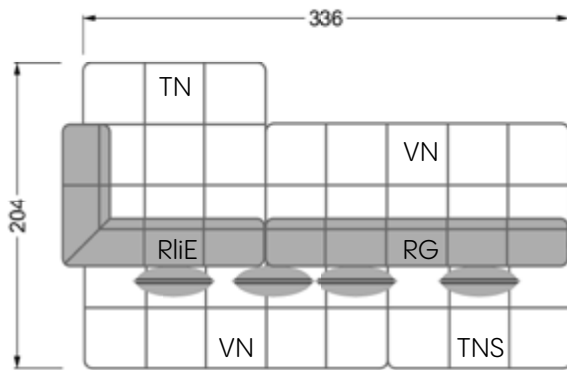

Kissenempfehlung: **D 108 Q**

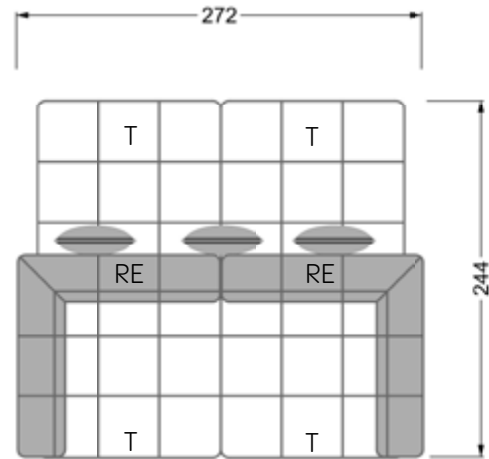
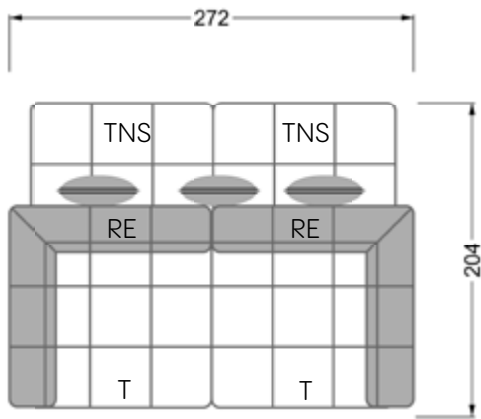
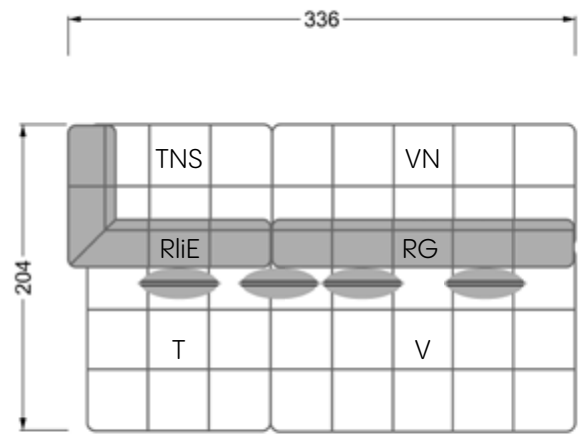
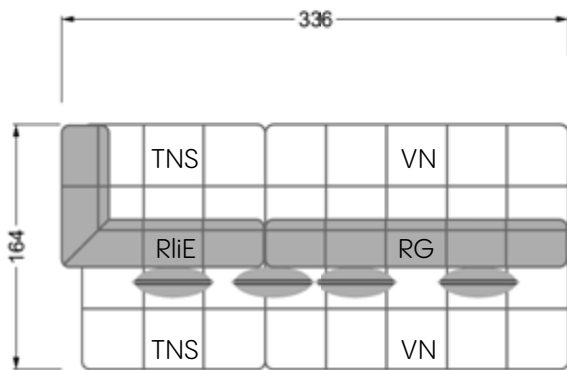

Kissenempfehlung: **D 108 Q**

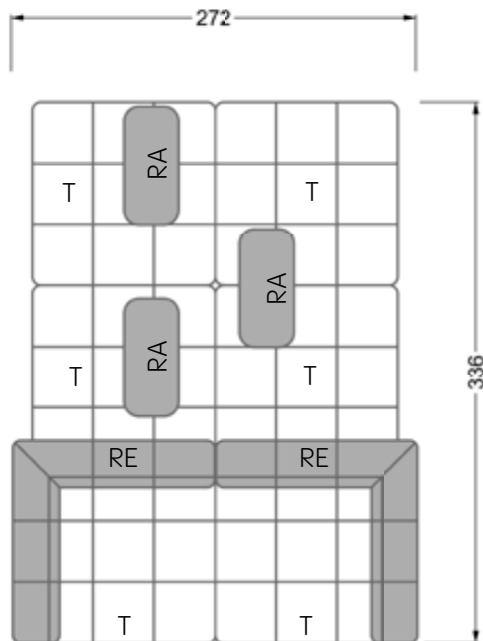



Bretz
German Manufacture
Since 1895

Head Office & Showroom:
Alexander-Bretz-Str. 2
D-55457 Gensingen
Tel +496727-895-0
E-Mail info@bretz.de

Bretz Sales Flagships & Partners:
bretz.de

f BretzSofas
ig @bretz_sofas

Bretz
True Characters