

# User Manual

It's my pleasure to help you!



## PREPARATION FOR USE

### Unpacking and Set Up

- Remove the radio from the carton and remove all packing material from the radio. **Save the packing material, if possible, in case the radio ever needs to be serviced or transported. The original carton and packing material is the only safe way to pack your radio to protect it from damage in transit.**
- Remove any descriptive labels or stickers on the front or top of the cabinet. Do not remove any labels or stickers from the back or bottom of the cabinet.
- Note the serial number on the bottom of your radio and write this number in the space provided on the Warranty page of this manual.
- Place your radio on a level surface such as a table, desk or shell, out of direct sunlight, and away from sources of excess heat, dirt, dust, moisture, humidity or vibration.
- Unwind the USB cable and extend it to its full length.

## IMPORTANT NOTES

- Avoid installing this unit in places exposed to direct sunlight or close to heat radiating appliances such as: electric heaters, on top of other stereo equipment that radiates heat, places lacking ventilation, dusty areas, places subject to constant vibration and/or humid or moist areas.
- Operate controls and switches as described in the manual.
- Before turning on the power, make certain that the USB cable, is connected

1. ALARM 1 Radio/Buzzer Indicator
2. ALARM 2 Radio/Buzzer Indicator
3. PM Indicator
4. MHZ Indicator
5. kHz Indicator
6. TIME SET Button
7. MEM./STORE Button
8. AL1 Button
9. AL2 Button
10. FM Radio Button
11. SNOOZE/DIMMER/SLEEP Button
12. AM Radio Button
13. TUNE+ ▲ Button
14. TUNE- ▼ Button
15. Volume+ Button
16. Volume- Button
17. USB CABLE
18. AM/FM ANTENNA

## SETTING THE TIME

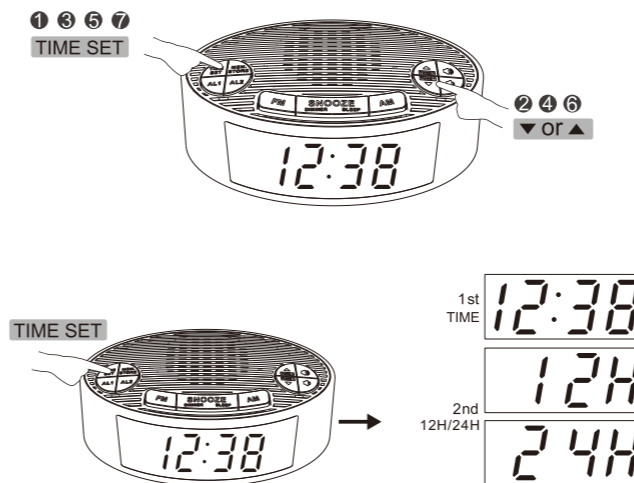

1. Press "AL1" repeatedly to select your alarm ringtone: When "1" is on the display, Alarm 1 (Wake to Buzzer) is turned on. When "1" is on the display, Alarm 1 (Wake to Radio) is turned on. If both "1" and "1" disappear on the display, Alarm 1 is completely turned off. After selecting your desired alarm ringtone,
2. Press and hold "AL1" for 2 seconds and the "HOUR" digits will blink.
3. Press "▼" or "▲" to adjust the hour.
4. Press the "AL1" button again, and the "MINUTE" digits will blink.
5. Press "▼" or "▲" to adjust the minute.
6. Press the "AL1" button again, and the "CURRENT VOLUME LEVEL" digits will blink. The volume levels range from V01 to V16. (The volume can only be set when using radio to wake up.)
7. Press "▼" or "▲" to adjust to your desired alarm volume level.
8. Press "AL1" or wait for 40 seconds to finish the alarm setting.

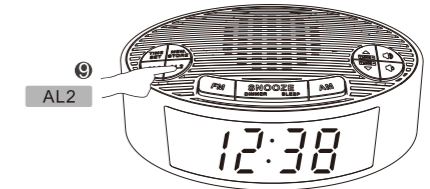

9. Please follow the above steps for setting the Alarm 2 (by pressing "AL2"). When the alarm goes off, it begins with the minimum volume and gradually increases to your preset alarm volume.

## SNOOZE/REPEAT/STOP THE ALARM

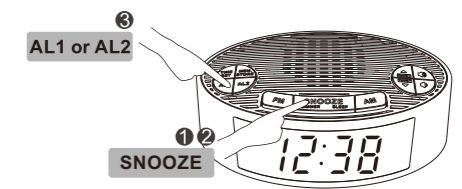

1. When the alarm goes off, you can press "SNOOZE" to doze for another 9 minutes.
2. Press "SNOOZE" again to further doze for another 9 minutes and you can repeatedly press "SNOOZE" for more dozings during the 60-minutes snooze cycle.
3. Press "AL1" or "AL2" button to stop the alarm from sounding. To deactivate the alarm completely, press "AL1" or "AL2" button repeatedly until all the alarm indicator OFF from the display.

## PLAYING THE AM/FM RADIO

Keep the clock radio away from other electronic devices to avoid radio interference. For better reception, fully extend and adjust the position of the antenna.

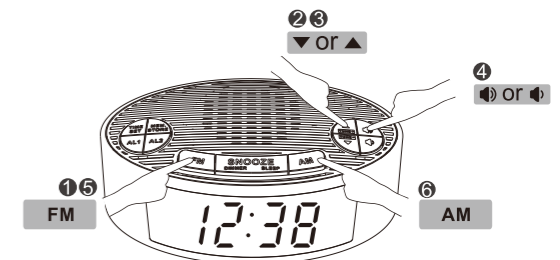

1. Press "FM" to switch to the radio mode, which will be the last radio station setting, and the "MHz" digits will appear on the display.
2. Press "▼" or "▲" to adjust the radio frequency.
3. Press and hold "▼" or "▲" for auto-search. The search will stop at the next available lower or higher station.
4. While listening to your desired station, you can press "or" "or" to adjust the radio volume level.
5. When you turn off the radio (by pressing "FM"), the last station you listened to will be your wake-to-radio station.
6. Please follow the above steps for setting the AM RADIO (Press the "AM" button, the "kHz" digits will appear on the display, and the operation can begin.)

Visit our website at [www.itoma.com](http://www.itoma.com)

## WARNING

TO PREVENT FIRE OR SHOCK HAZARD, DO NOT USE THIS PLUG WITH AN EXTENSION CORD, RECEPTACLE OR OTHER OUTLET UNLESS THE BLADES CAN BE FULLY INSERTED AND THERE IS NO BLADE EXPOSURE. TO PREVENT FIRE OR SHOCK HAZARD, DO NOT EXPOSE THIS APPLIANCE TO RAIN OR MOISTURE.

<p>The lightning flash with arrow-head symbol, within an equilateral triangle is intended to alert the user to the presence of uninsulated 'dangerous voltage' within the product's enclosure that may be of sufficient magnitude to constitute a risk of electric shock to persons.</p>	<p><b>CAUTION</b> RISK OF ELECTRIC SHOCK DO NOT OPEN</p> <p>WARNING: TO REDUCE THE RISK OF ELECTRIC SHOCK DO NOT REMOVE COVER (OR BACK). NO USER SERVICEABLE PARTS INSIDE. REFER SERVICING TO QUALIFIED SERVICE PERSONNEL.</p>	<p>The exclamation point within an equilateral triangle is intended to alert the user to the presence of important operating and maintenance (servicing) instructions in the literature accompanying the appliance.</p>
--	--	---

## IMPORTANT SAFETY INSTRUCTIONS

- 1.) Read these instructions. Keep these instructions. Follow all instructions. Heed all warnings.
- 2.) Do not use this apparatus near water.
- 3.) Clean only with dry cloth.
- 4.) Do not block any ventilation openings. Install in accordance with the manufacturer's instructions.
- 5.) Do not install near any heat sources such as radiators, heaters, stoves, or other apparatus (including amplifiers) that produce heat.
- 6.) Do not defeat the safety purpose of the polarized or grounding-type plug. A polarized plug has two blades with one wider than the other. A grounding type plug has two blades and a third grounding prong. The wide blade or the third prong is provided for your safety. If the provided plug does not fit into your outlet, ask an electrician for replace the obsolete outlet.
- 7.) Protect the power cord from being walked on or pinched particularly at plugs, convenience receptacles and the point where they exit from the apparatus.
- 8.) Only use attachments / accessories specified by the manufacturer.
- 9.) Unplug this apparatus during lightning storms or when unused for long periods of time.
- 10.) Refer all servicing to qualified service personnel. Servicing is required when the apparatus has been damaged in any way, such as power-supply cord or plug is damaged, liquid has been spilled or objects have fallen into the apparatus, the apparatus has been exposed to rain or moisture, does not operate normally or has been dropped.
- 11.) Use only with the cart, stand, tripod, bracket, or table specified by the manufacturer, or sold with the apparatus. When a cart is used, use caution when moving the cart / apparatus combination to avoid injury from tip-over.



## LOCATION OF CONTENTS AND INDICATORS

### FRONT PANEL



### TOP PANEL

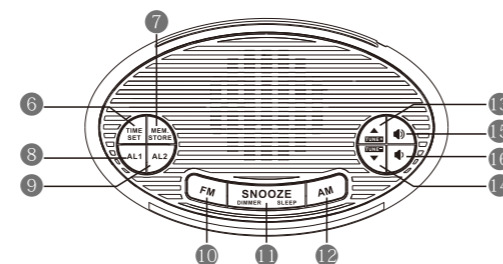

### BACK PANEL

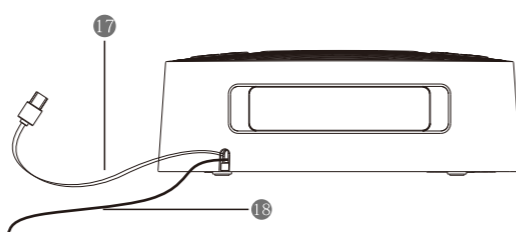

1. Press and hold "TIME SET" until the "HOUR" digits blink.
2. Press "▼" or "▲" to adjust the hour.
3. Press "TIME SET" again, the "MINUTE" digits will blink.
4. Press "▼" or "▲" to adjust the minute.
5. Press "TIME SET" again, the "12H" digits will blink.
6. Press "▼" or "▲" to choose 12H or 24H.
7. Press "TIME SET" again or wait for 40 seconds to return to the clock display.

## SETTING THE ALARM

(Turn off the clock radio before setting the alarm)

Your clock radio has two separate alarms (Alarm 1 and Alarm 2) that can be set and used independently. Please ensure that you have set the wakeup time(s) and alarm correctly.

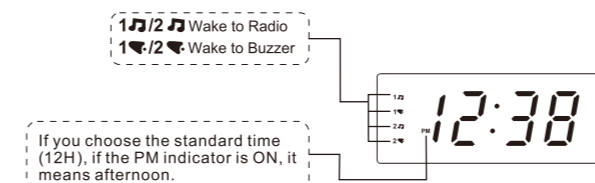

### Setting the Wakeup Alarms

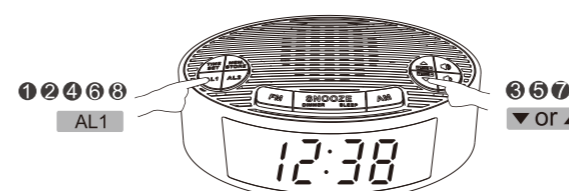

## Storing Radio Station Presets (Max. 40 presets)

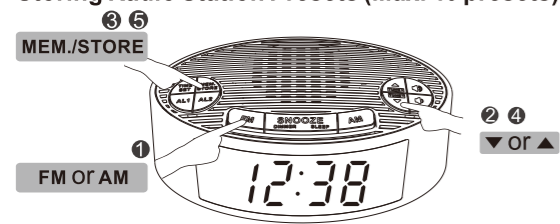

There are 20 AM and 20 FM preset stations can be stored on the radio clock, for a total of 40 preset stations.

- ① Press "FM" or "AM" to turn on the clock radio.
  - ② Search your desired station by pressing "v" or "^"
  - ③ Press and hold "MEM./STORE" until the "PROGRAM NUMBER" (from P01 to P20) blinks.
  - ④ Press "v" or "^" to select the desired Program Number.
  - ⑤ Press "MEM./STORE" again and the desired station will be stored under the desired Program Number.
- Repeat the above steps 1-5 to store additional stations as presets.

## Recalling Preset Radio Stations

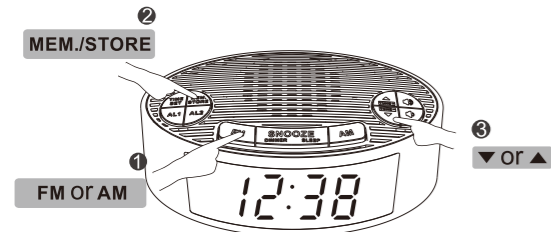

- ① Press "FM" or "AM" to turn on the clock radio.
- ② Press "MEM./STORE" once and the Program Number will appear on the display.
- ③ Press "v" or "^" repeatedly to select your desired preset station.

-8-

## USING THE SLEEP TIMER

You can fall asleep to the radio using the sleep timer, which is set up in 10-minute increments (The sleep timer duration ranges from 10 minutes to 90 minutes). After reaching the desired duration, the radio will turn off automatically.

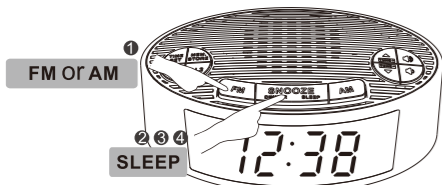

- ① Press "FM" or "AM" to turn on the clock radio.
- ② Press "SLEEP" and the "10" digit will appear on the display which indicates the sleep timer has been set for 10 minutes.
- ③ To change the sleep timer duration, keep pressing "SLEEP" until your desired duration appears.
- ④ To deactivate the sleep timer, keep pressing "SLEEP" until "OFF" appears on the display, or press "FM" or "AM" to turn off the sleep timer directly.

## 4-LEVELS OF DIMMER CONTROL

The display brightness can only be adjusted when the radio is turned off. To adjust the display brightness, keep "SNOOZE/DIMMER/SLEEP" Button desired brightness level appears.

Brightness is available in 4 levels and can be adjusted, you can adjust the brightness level as below:

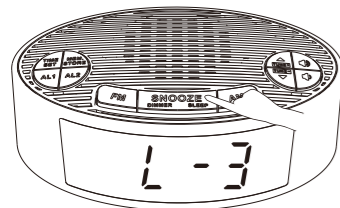

Highlighted	L-3
Medium	L-2
Low dark	L-1
OFF	OFF

-9-

## CARE AND MAINTENANCE

### Care of Cabinets

If the cabinet becomes dusty, wipe it with a soft cloth. If the cabinet becomes smudged or dirty, clean it with a soft, slightly dampened cloth. Never allow water or any liquid to get inside the cabinet. Never use any abrasive cleaners or cleaning pads as these will damage the finish of your radio.

## FCC WARNING

### FCC PART 15.19 WARNING STATEMENT

THIS DEVICE COMPLIES WITH PART 15 OF THE FCC RULES. OPERATION IS SUBJECT TO THE FOLLOWING IWO CONDITIONS:

- (1) THIS DEVICE MAY NOT CAUSE HARMFUL INTERFERENCE. AND
- (2) THIS DEVICE MUST ACCEPT ANY INTERFERENCE RECEIVED, INCLUDING INTERFERENCE THAT MAY CAUSE UNDESIRED OPERATION.

### FCC PART 15.21 WARNING STATEMENT

NOTE: THE GRANTEE IS NOT RESPONSIBLE FOR ANY CHANGES OR MODIFICATIONS NOT EXPRESSLY APPROVED BY THE PARTY RESPONSIBLE FOR COMPLIANCE. SUCH MODIFICATIONS COULD VOID THE USER'S AUTHORITY TO OPERATE THE EQUIPMENT.

### FCC Part 15.105 Warning Statement

Note: This equipment has been tested and found to comply with the limits for a Class B digital device, pursuant to part 15 of the FCC Rules. These limits are designed to provide reasonable protection against harmful interference in a residential installation. This equipment generates, uses and can radiate radio frequency energy and, if not installed and used in accordance with the instructions, may cause harmful interference to radio communications. However, there is no guarantee that interference will not occur in a particular installation. If this equipment does cause harmful interference to radio or television reception, which can be determined by turning the equipment off and on, the user is encouraged to try to correct the interference by one or more of the following measures:

- Reorient or relocate the receiving antenna.
- Increase the separation between the equipment and receiver.
- Connect the equipment into an outlet on a circuit different from that to which the receiver is connected.
- Consult the dealer or an experienced radio/TV technician for help.

### RF warning statement:

The device has been evaluated to meet general RF exposure requirement. To maintain compliance with FCC's RF exposure guidelines, this equipment should be installed and operated with a minimum distance of 20cm between the radiator and your body.

-10-