

Risco

Floating smartphone stand

1

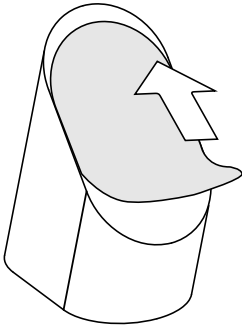

Remove the protective film

2

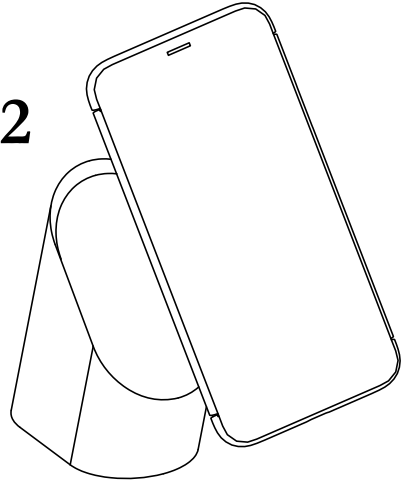

Now you can place your
smartphone

(Depending on the texture of the smartphone
and case, it will stick more or less, take your
time to get used to the removable adhesive)

3

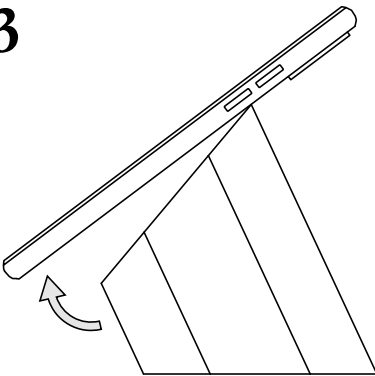

Release your phone with a lever
motion

4

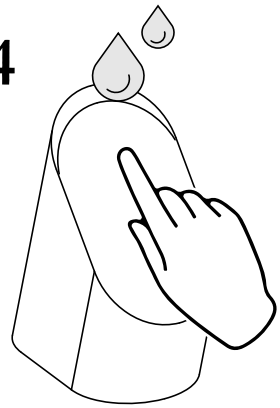

When the adhesive gets dirty,
wash gently with your fingers,
with water and without soap

Mallo

Slim headphones stand

1

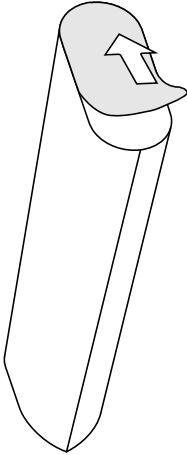

Remove the protective film

2



Now you can place it in
any surface

(Depending on the surface, it will stick more
or less, take your time to get used to the
removable adhesive)

3

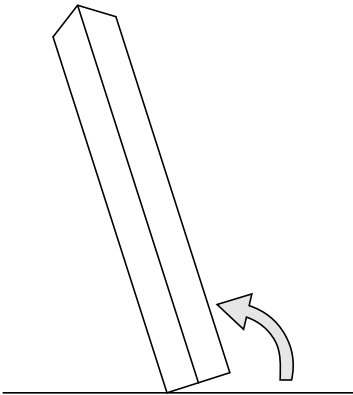

Mallo will release easier if you
tilt it to one side

4



When the adhesive gets dirty,
wash gently with your fingers,
with water and without soap.

Loma

Vertical laptop stand

1 Try out the leather strip and supplement with your computer before sticking it, to find the best fit.

Option a

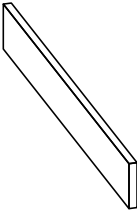

Use only the vegan leather strip

Option b

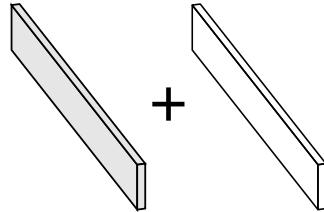

Use the vegan leather strip with the supplement

* For Apple products we recommend the different options on the back

2 Remove the protective film/s and place it

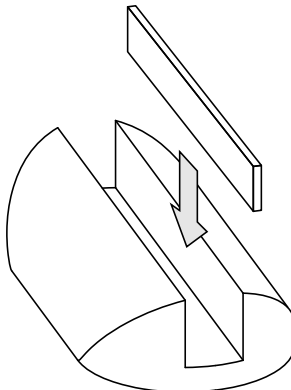

★

A compatible with:

Macbook Air 13,3" - 2020

Macbook Pro 16"

Laptops 15,7 mm - 16,2 mm
(Thickness)

B compatible with:

Macbook Air 13" - 2018,2019

Macbook Pro 13", 15"

Laptops 14,9 mm - 15,6 mm
(Thickness)

Sima

Apple pencil stand

