

Alba Wall shelf

MANUAL DE MONTAJE

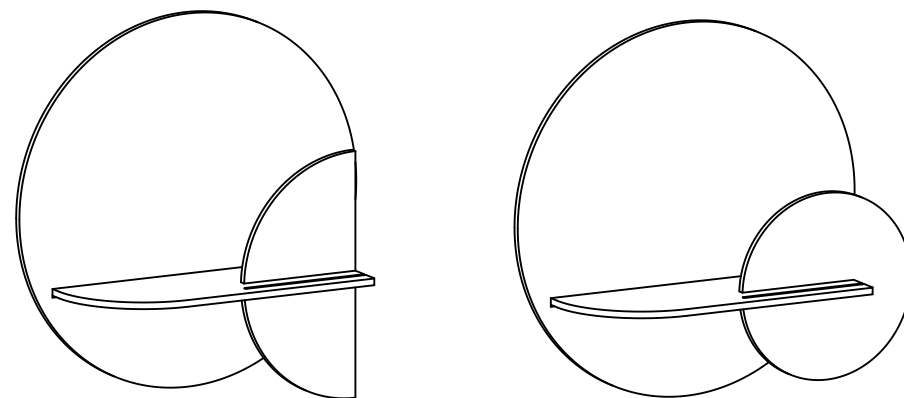

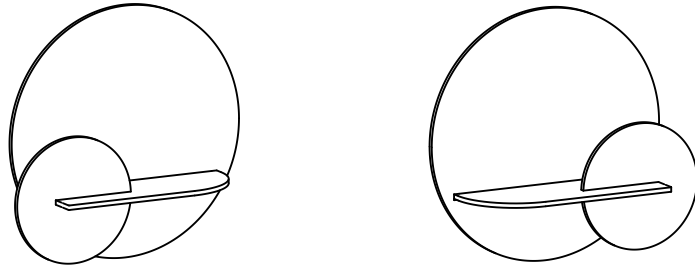

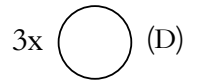
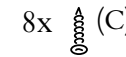
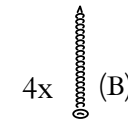
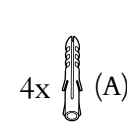
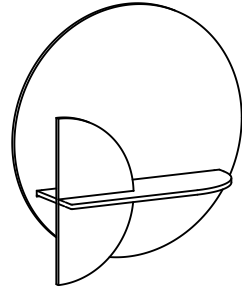
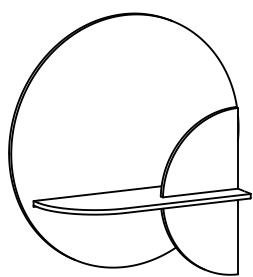
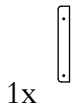
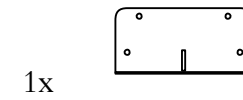
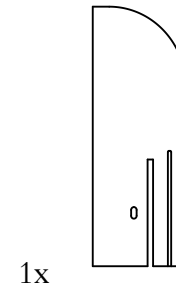
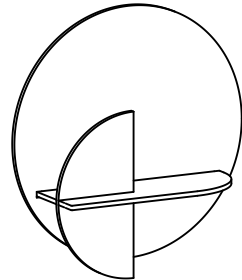
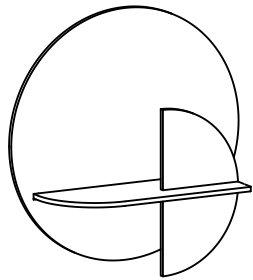
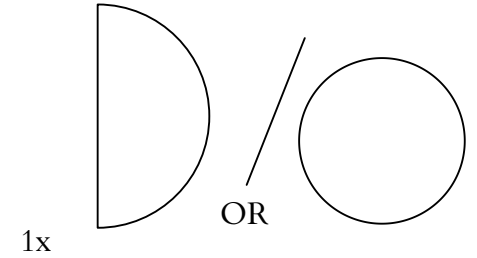
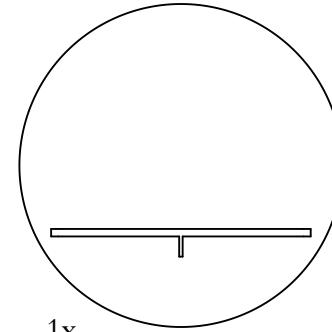

2 POSIBILIDADES DIFERENTES



4 POSIBILIDADES DIFERENTES

 Recomendamos a dos personas para la instalación

 Necesitará un taladro manual para los agujeros de la pared



La broca requerida es de \varnothing 6 mm o 15/64" Profundidad del agujero de la pared: 50 mm / 1.96"

Para que el agujero tenga la profundidad exacta, mida 50 mm / 1.97" en la broca y coloque una cinta alrededor para marcar la distancia. Pare de perforar cuando llegue a esa profundidad.

