

Alba Wall shelf

ASSEMBLY INSTRUCTIONS

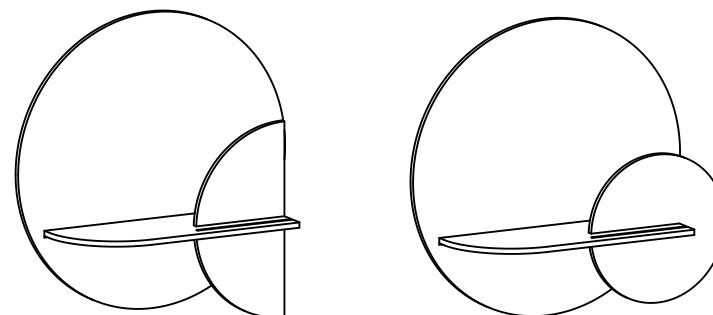

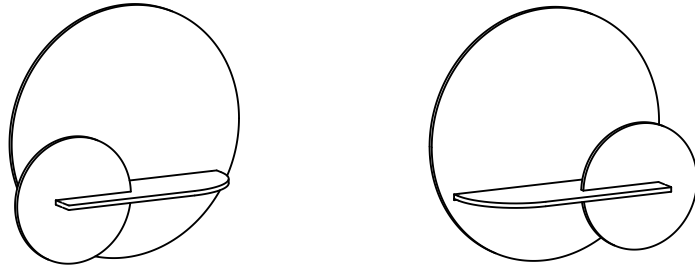

2 DIFFERENT POSSIBILITIES

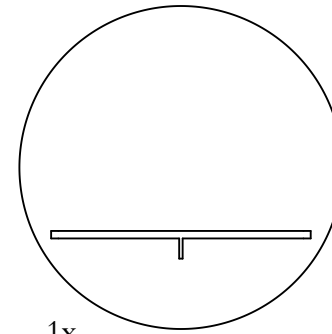

1x

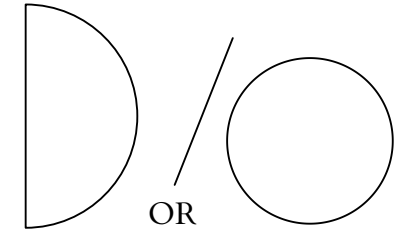

1x

OR

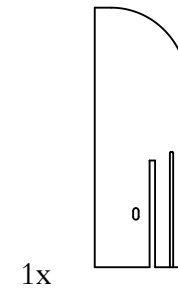
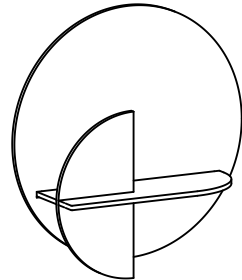
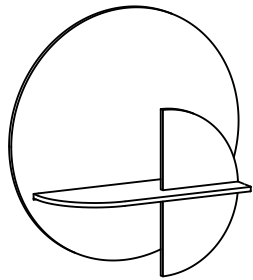

1x

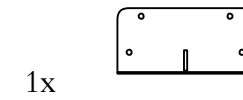

1x

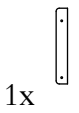

1x

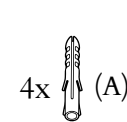
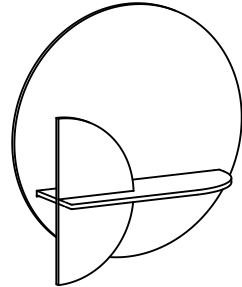
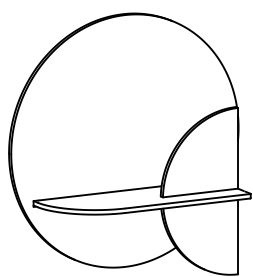

4x (A)

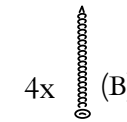

4x (B)

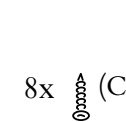

8x (C)

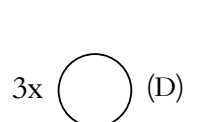

3x (D)

4 DIFFERENT POSSIBILITIES



We recommend two people for the installation



You will need a manual drill for the wall holes



The drill bit required is \varnothing 6 mm or 15/64" Depth of the hole in wall: 50 mm / 1.96"

For the hole to be the exact depth, measure 50mm/1.96" on the drill bit and place tape around it to mark the distance. Stop drilling when it reaches that depth.

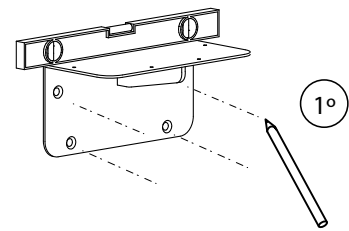

Use the level tool
Mark the holes with a pencil

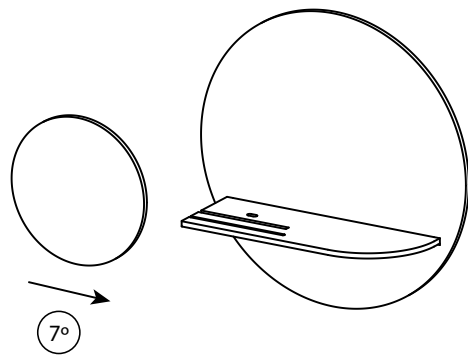
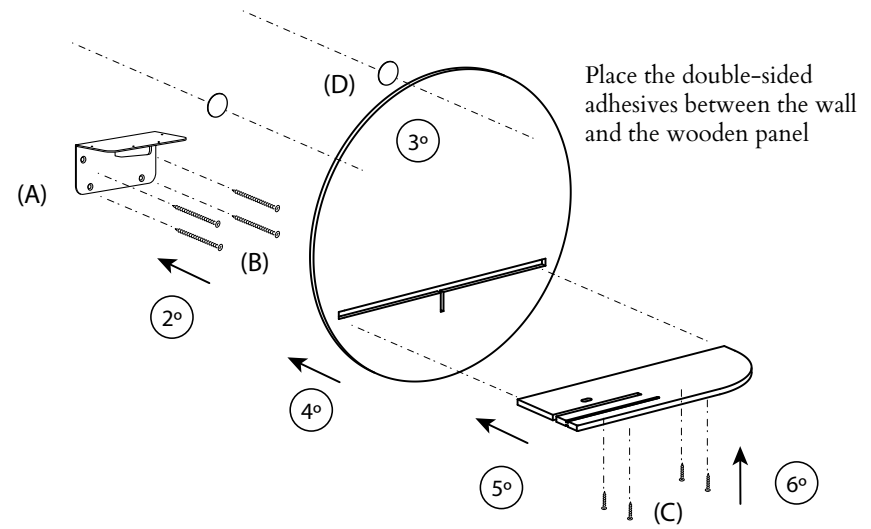

Introduce the small
wooden piece

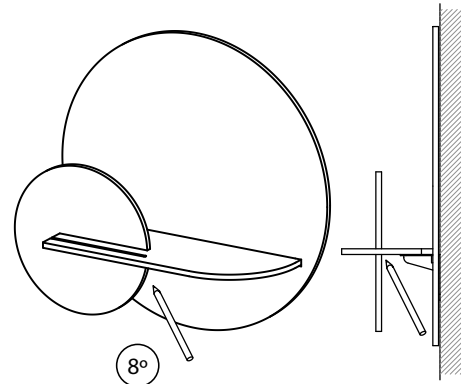

Make a line at the intersection of the
small piece of wood on the back

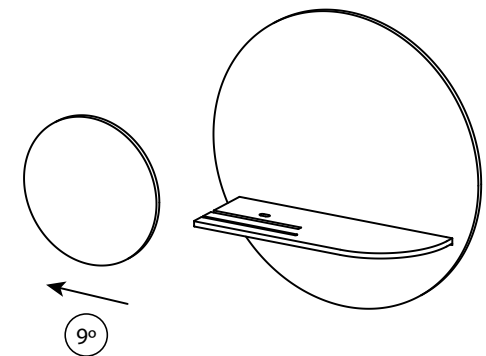

Take out the small
wooden piece

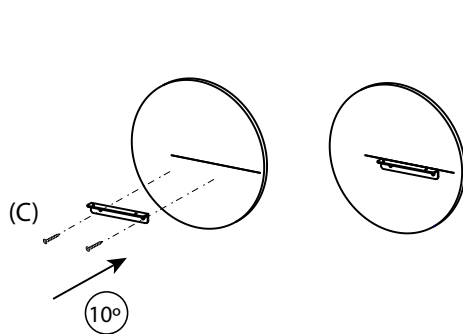

Screw on the L-shaped metal
piece using the marked line

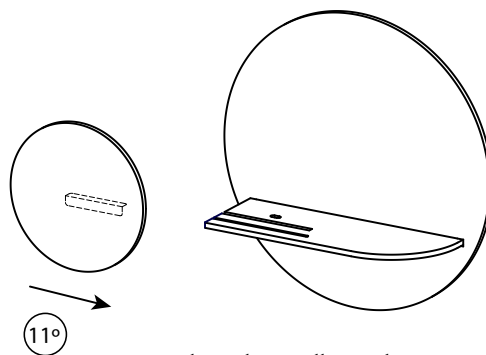

Introduce the small wooden piece
with the metal piece towards the back

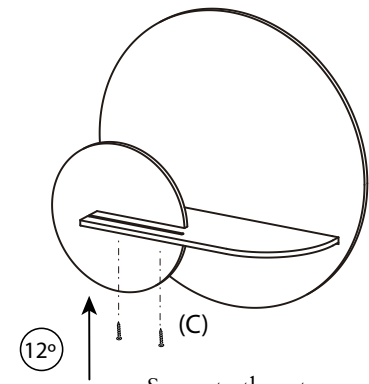

Screw to the set