

# Alba Wall shelf

## *MONTAGEHANDLEIDING*

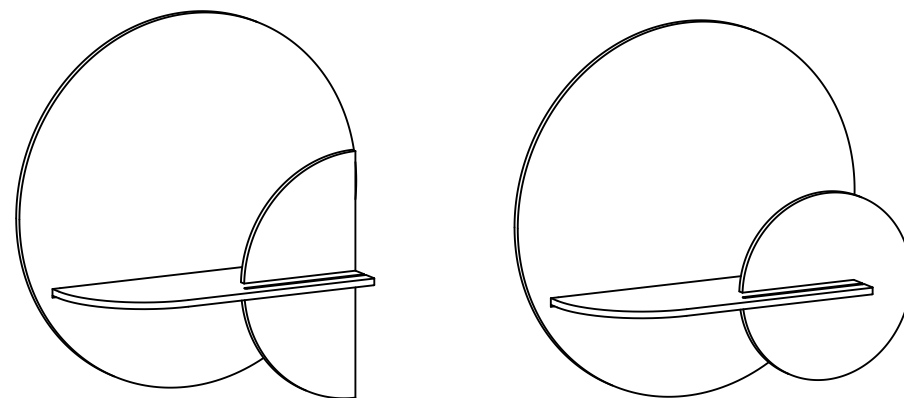

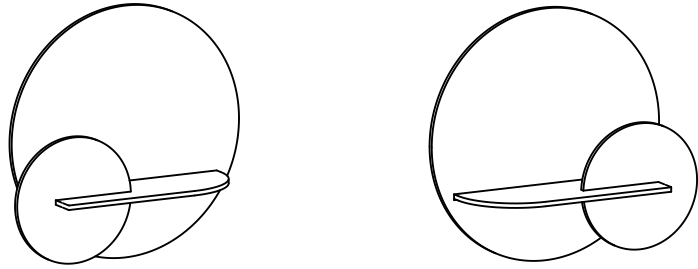

## 2 VERSCHILLENDE MOGELIJKHEDEN

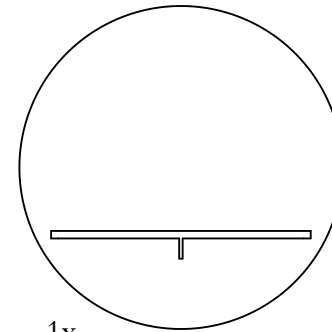

1x

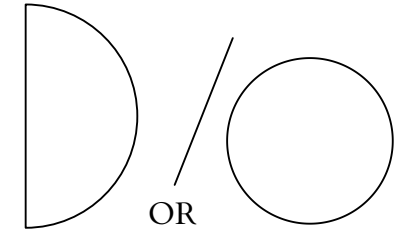

1x

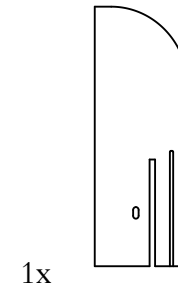
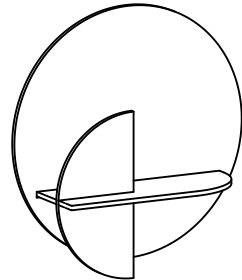
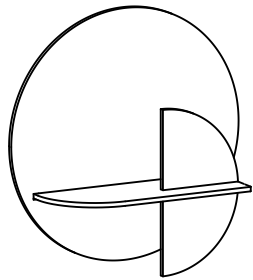

1x

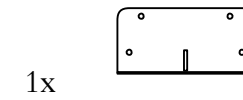

1x

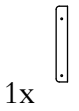

1x

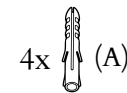
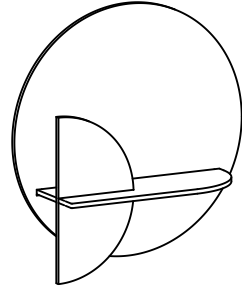
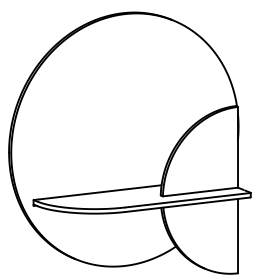

4x (A)

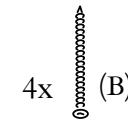

4x (B)

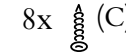

8x (C)

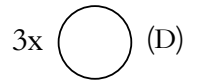

3x (D)

## 4 VERSCHILLENDE MOGELIJKHEDEN



We raden twee personen aan voor de installatie



Je hebt een handboor nodig voor de gaten in de muur



De benodigde boor is  $\varnothing$  6 mm of 15/64"  
Diepte van het gat in de muur: 50 mm/1.97"

Om het gat precies zo diep te maken, meet je 50 mm / 1.97" op de boor en plak je er plakband omheen om de afstand te markeren. Stop met boren wanneer het diepte bereikt.

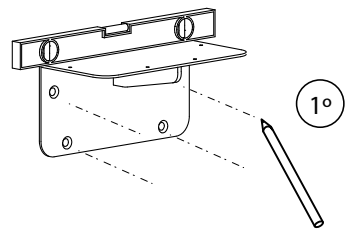

1°  
Gebruik het niveauhulpmiddel.  
Markeer de gaten met een  
potlood.

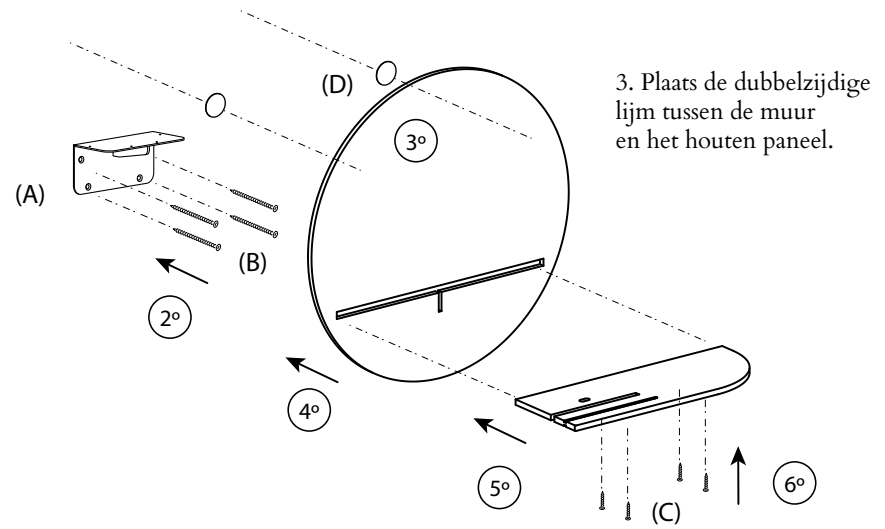

3. Plaats de dubbelzijdige  
lijm tussen de muur  
en het houten paneel.

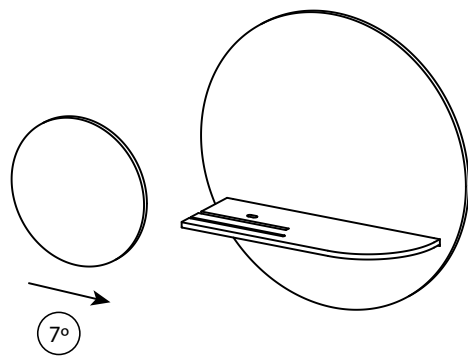

7°  
Introduceer het kleine  
houten stuk.

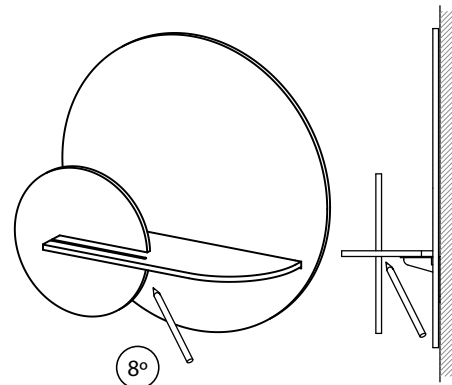

8°  
Maak een lijn op de kruising van het  
kleine stukje hout aan de achterkant.

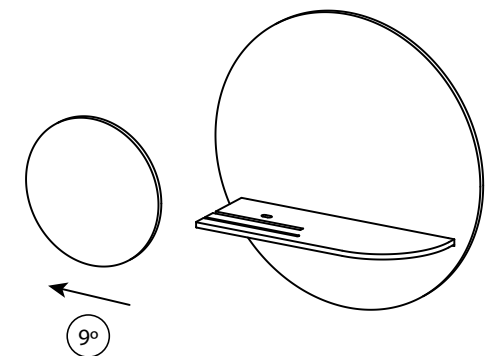

9°  
Haal de kleine eruit  
houten stuk.

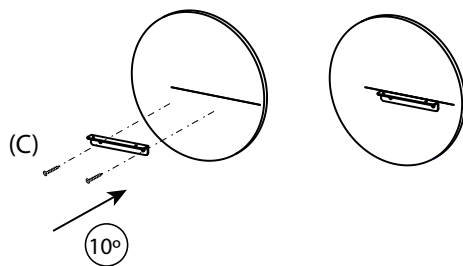

10°  
Schroef het L-vormige metaal vast  
stuk met behulp van de gemarkeerde lijn.

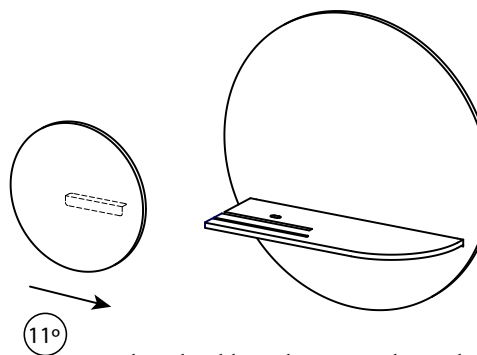

11°  
Plaats het kleine houten stuk met het  
metalen stuk naar achteren.

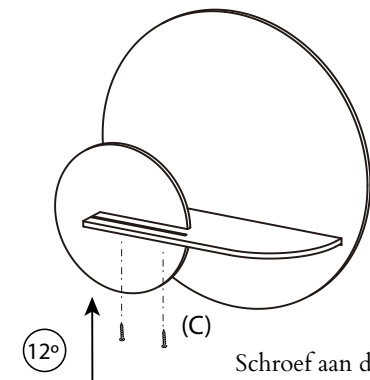

12°  
Schroef aan de set.