

Alba Wall shelf

MONTERINGSVEJLEDNING

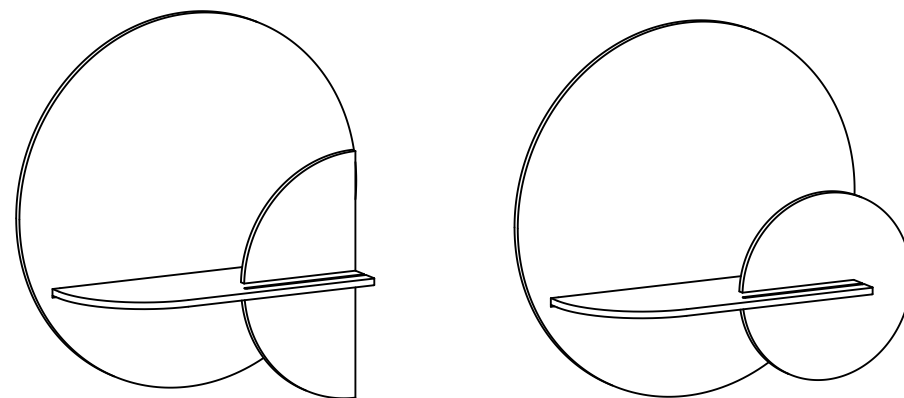

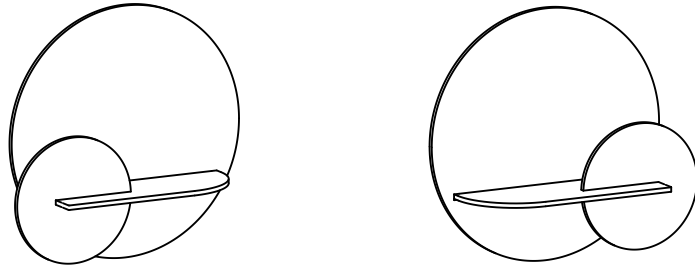

2 FORSKELLIGE MULIGHEDER

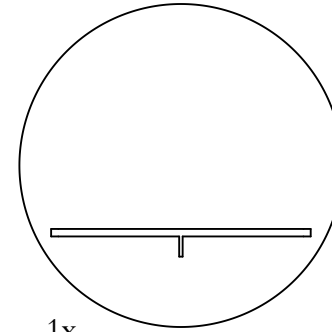

1x

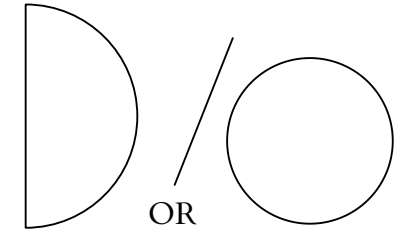

1x

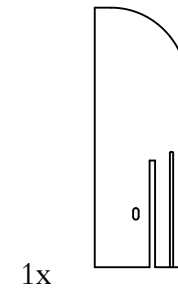
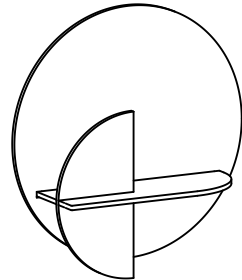
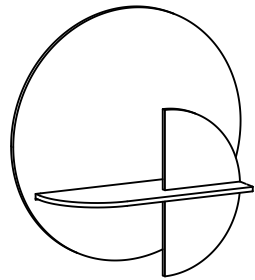

1x

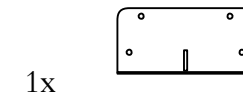

1x

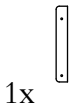

1x

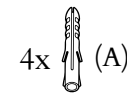
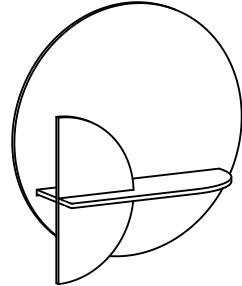
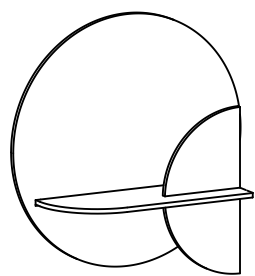

4x (A)

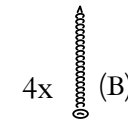

4x (B)

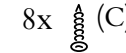

8x (C)

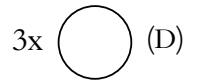

3x (D)

4 FORSKELLIGE MULIGHEDER



Vi anbefaler to personer til installationen



Du skal bruge en håndboremaskine til væghullerne



Det nødvendige bor er $\text{Ø } 6 \text{ mm}$ eller $15/64''$
Dybde af hul i væg: $50 \text{ mm} / 1,96''$

For at bestemme den nøjagtige dybde af huller skal du måle $50 \text{ mm} / 1,96''$ på boret og placere tape rundt om det for at markere afstanden. Stop med at bore, når det når denne dybde.

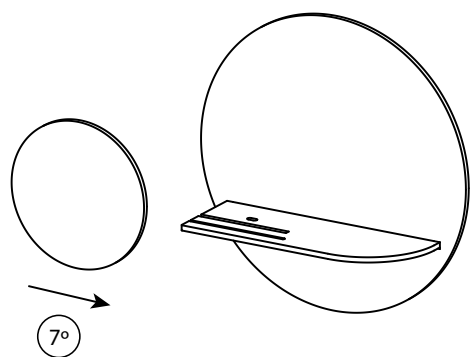
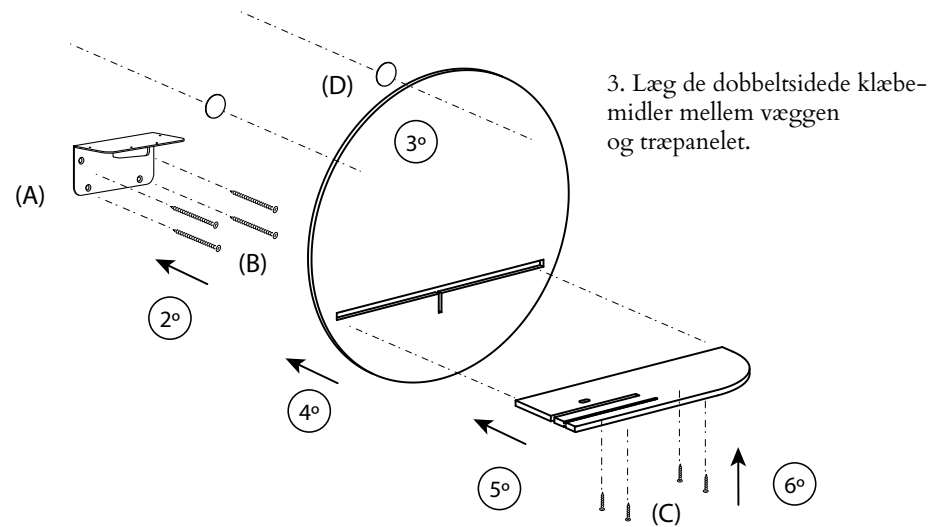
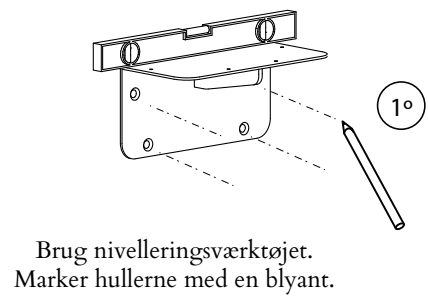

Indsæt det lille stykke træ.

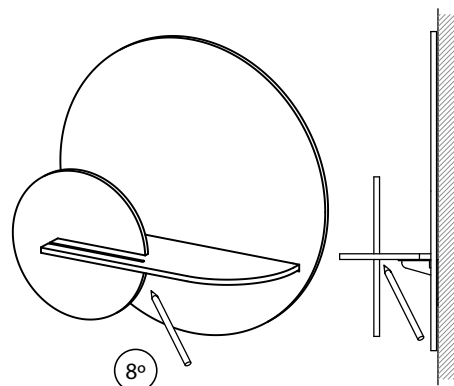

Lav en streg i skæringspunktet mellem det lille stykke træ på bagsiden.

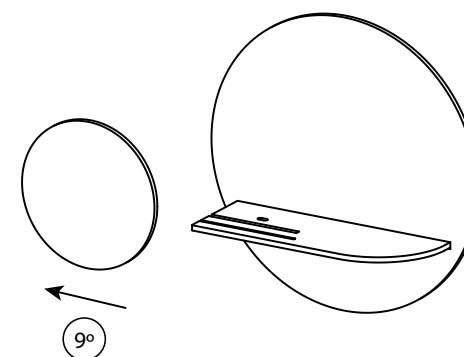

Tag den lille ud træstykke.

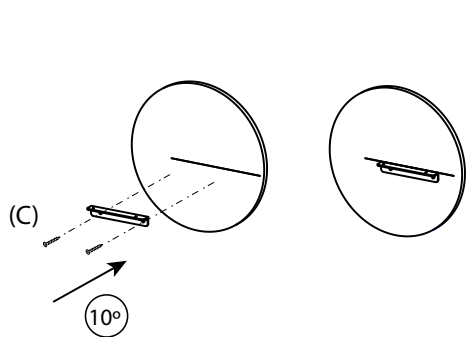

Skrue den L-formede metalplade ved hjælp af den markerede linje.

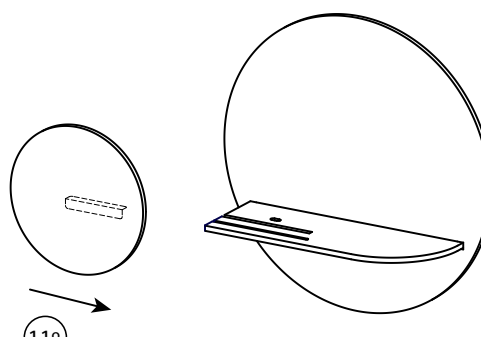

Indsæt det lille stykke træ med metalstykket på bagsiden.

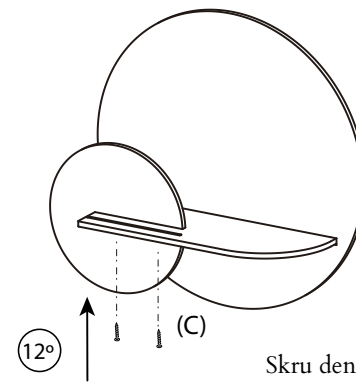

Skrue den fast sæt.