

Alba Slim nightstand

MONTAGEHANDLEIDING

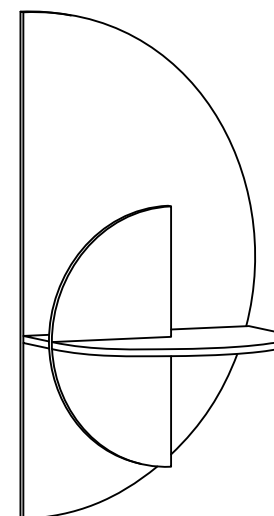

8 VERSCHILLENDE MOGELIJKHEDEN

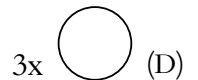
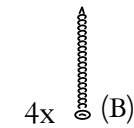
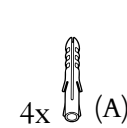
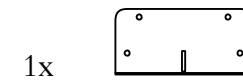
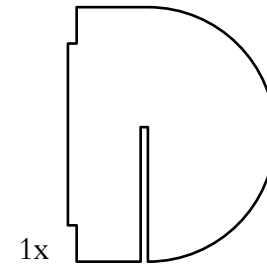
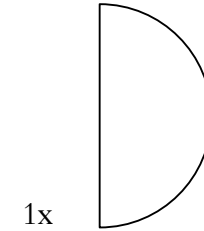
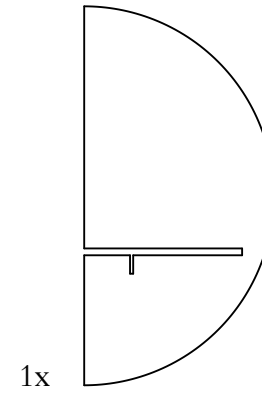
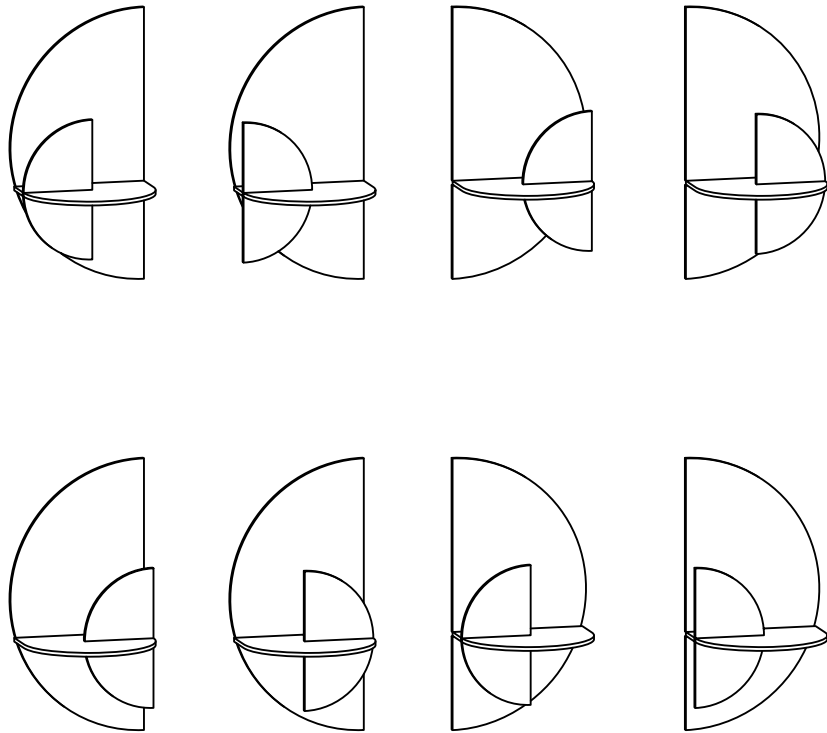

We raden twee personen aan voor de installatie



Je hebt een handboor nodig voor de gaten in de muur



De benodigde boor is $\text{Ø } 6 \text{ mm}$ of $15/64''$
Diepte van het gat in de muur: $50 \text{ mm} / 1.97''$

Om het gat precies zo diep te maken, meet je $50 \text{ mm} / 1.97''$ op de boor en plak je er plakband omheen om de afstand te markeren. Stop met boren wanneer het die diepte bereikt.

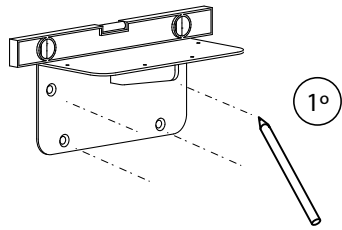

1°
Gebruik het niveauhulpmiddel.
Markeer de gaten met een
potlood.

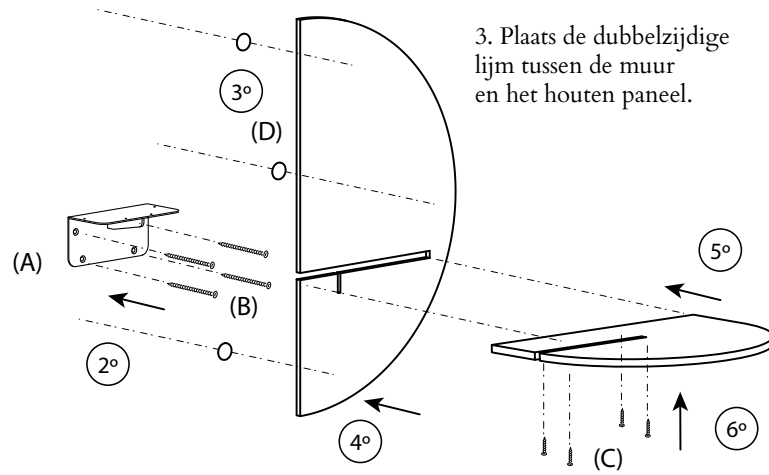

3. Plaats de dubbelzijdige
lijm tussen de muur
en het houten paneel.

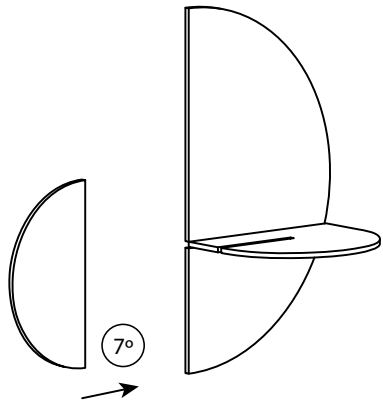

7°
Introduceer het kleine
houten stuk.

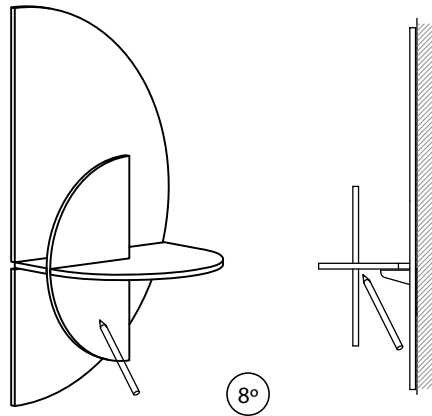

8°
Maak een lijn op de kruising van het
kleine stukje hout aan de achterkant.

Haal de kleine eruit
houten stuk.

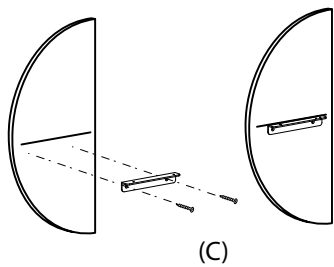
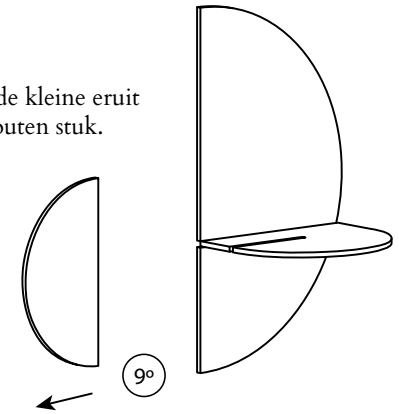

10°
Schroef het L-vormige metaal vast
stuk met behulp van de gemarkeerde lijn.

Plaats het kleine houten stuk met het
metalen stuk naar achteren.

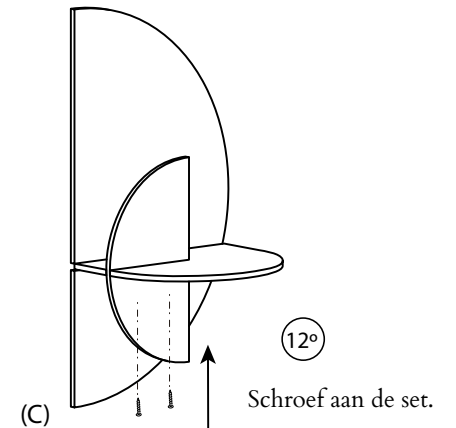
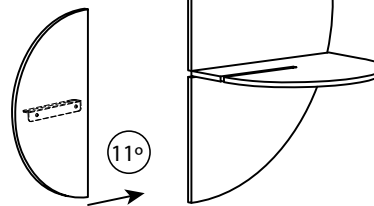

12°
Schroef aan de set.