

# Alba Slim nightstand

## *MONTAGEHANDLEIDING*

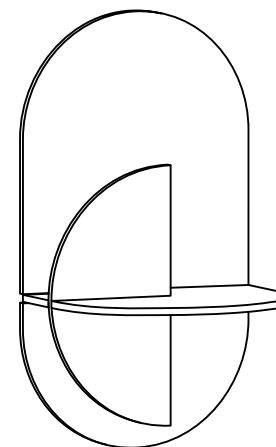

# 4 VERSCHILLENDE MOGELIJKHEDEN

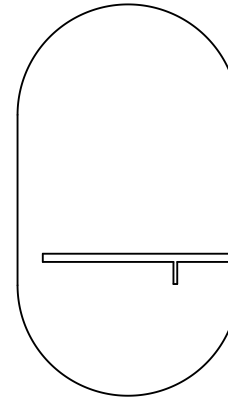
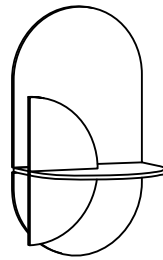
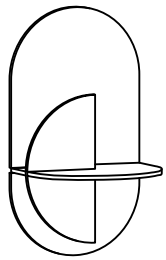
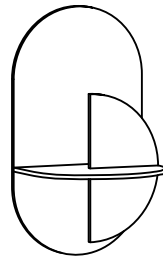
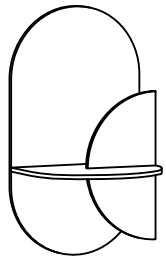

1x

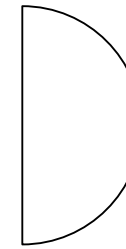

1x

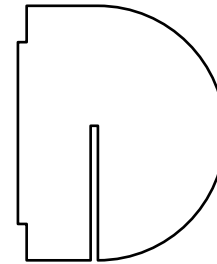

1x

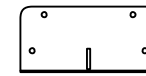

1x



1x

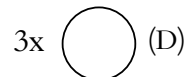
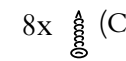
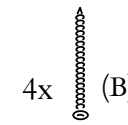
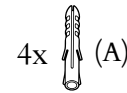

We raden twee personen aan voor de installatie



Je hebt een handboor nodig voor de gaten in de muur



De benodigde boor is  $\varnothing$  6 mm of 15/64"  
Diepte van het gat in de muur: 50 mm/1.97"

Om het gat precies zo diep te maken, meet je 50 mm / 1.97" op de boor en plak je er plakband omheen om de afstand te markeren. Stop met boren wanneer het diepte bereikt.

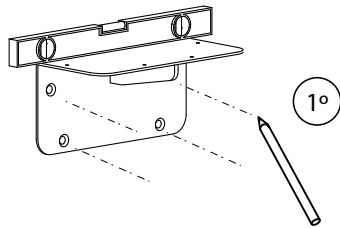

Gebruik het niveauhulpmiddel.  
Markeer de gaten met een  
potlood.

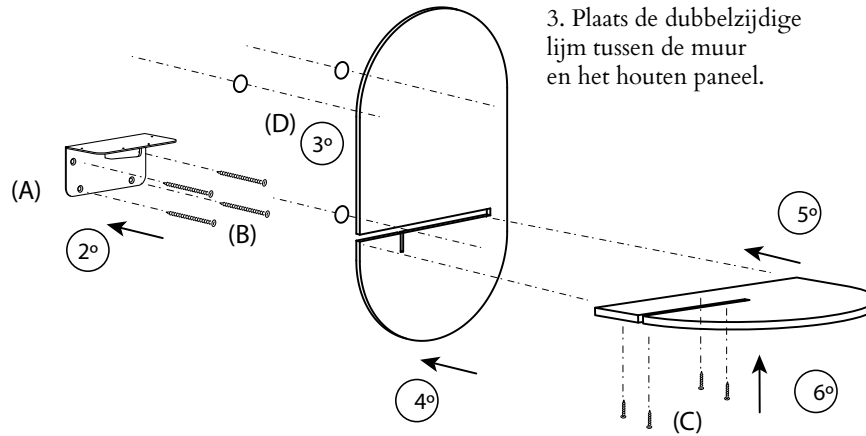

3. Plaats de dubbelzijdige  
lijm tussen de muur  
en het houten paneel.

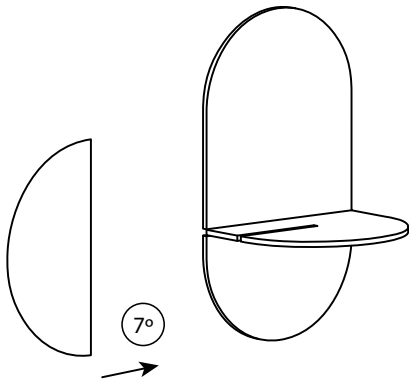

Introduceer het kleine  
houten stuk.

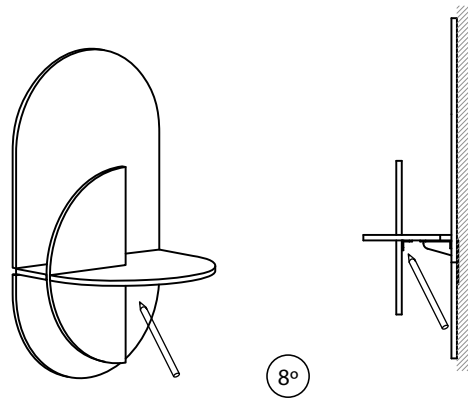

Maak een lijn op de kruising van het  
kleine stukje hout aan de achterkant.

Haal de kleine eruit  
houten stuk.

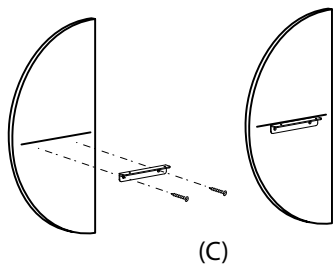
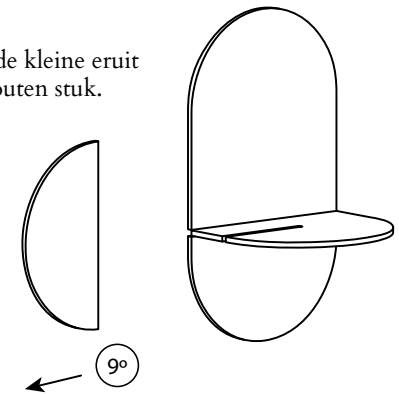

Schroef het L-vormige metaal vast  
stuk met behulp van de gemarkeerde lijn.

Plaats het kleine houten stuk met het  
metalen stuk naar achteren.

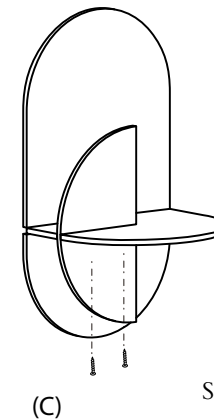
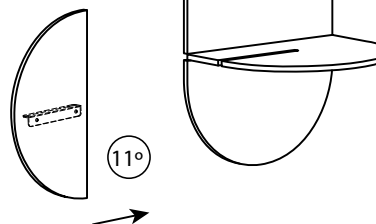

Schroef aan de set.