

Alba Floating nightstand

INSTRUCTIONS D'ASSEMBLAGE

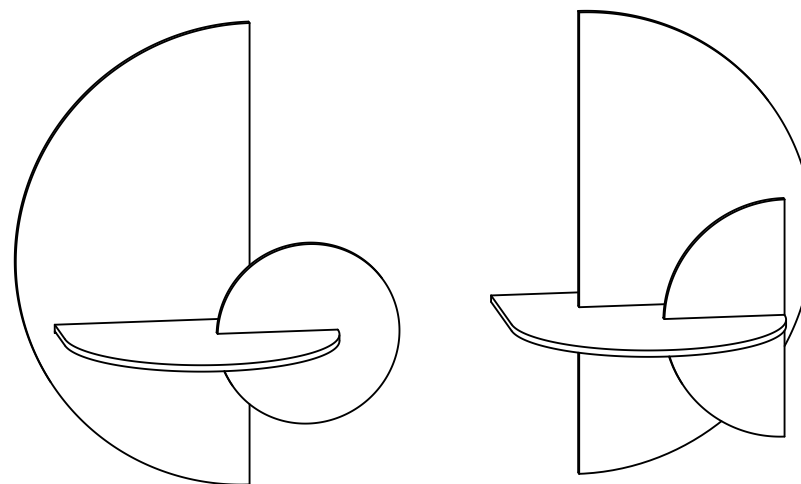

Woodendot

LIVE DESIGN

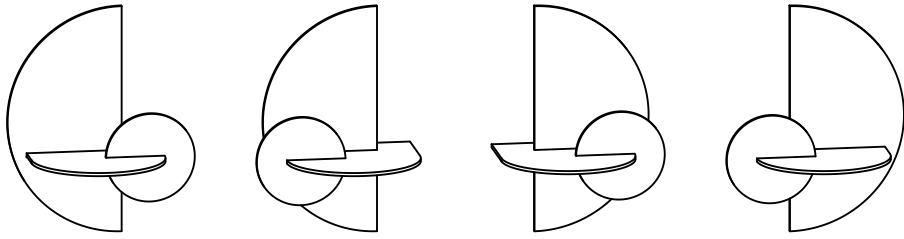

4 POSSIBILITÉS DIFFÉRENTES

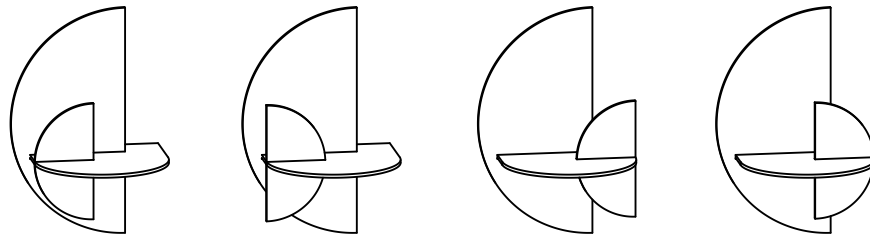
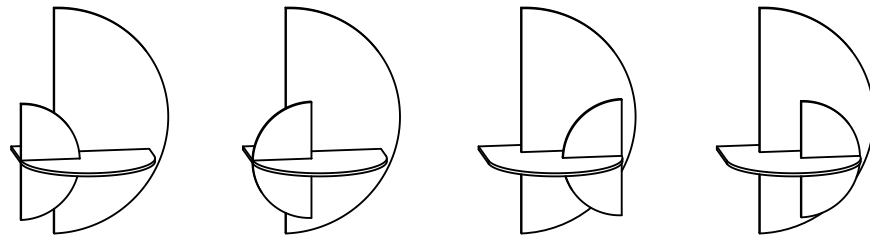
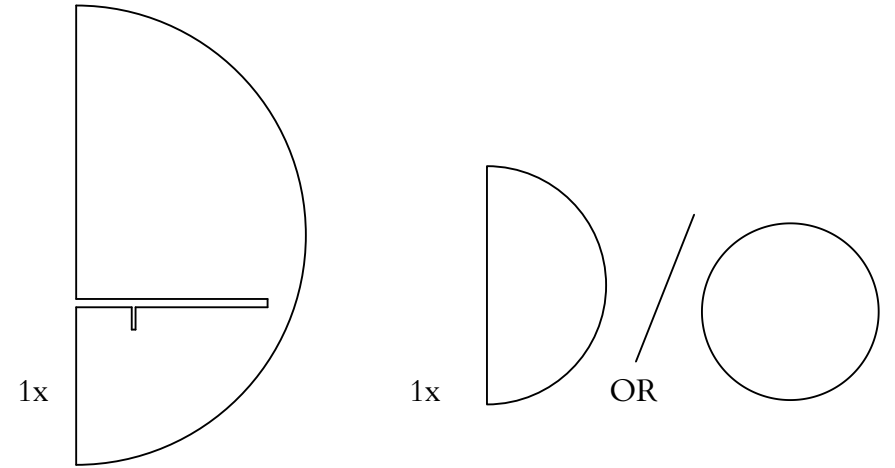

8 POSSIBILITÉS DIFFÉRENTES

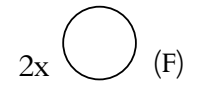
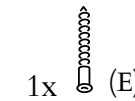
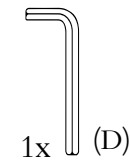
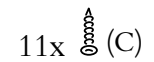
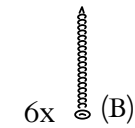
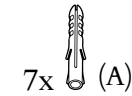
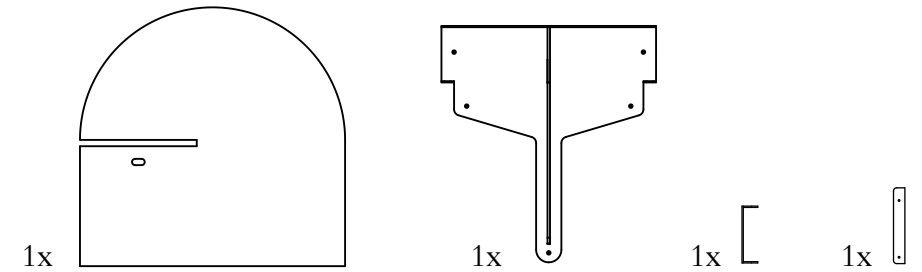

Nous recommandons deux personnes pour l'installation



Vous aurez besoin d'une perceuse à main pour les trous dans le mur



La mèche nécessaire est Ø 6 mm ou 15/64"
Profondeur du trou dans le mur: 50 mm / 1.96"

Pour que le trou soit exactement à la bonne profondeur, mesurez 50 mm / 1,97" sur la mèche et placez un ruban adhésif autour de cette mesure pour marquer le trou. Arrêtez de percer lorsque vous atteignez cette profondeur.

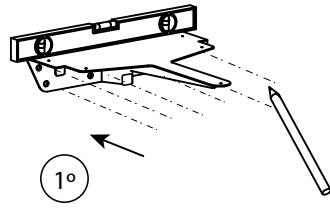

1° Utiliser l'outil de nivellement
Marquer les trous avec un crayon

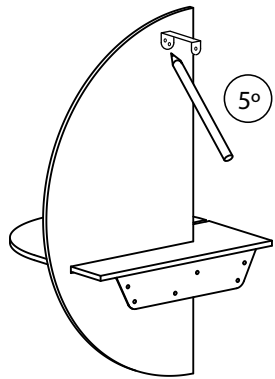
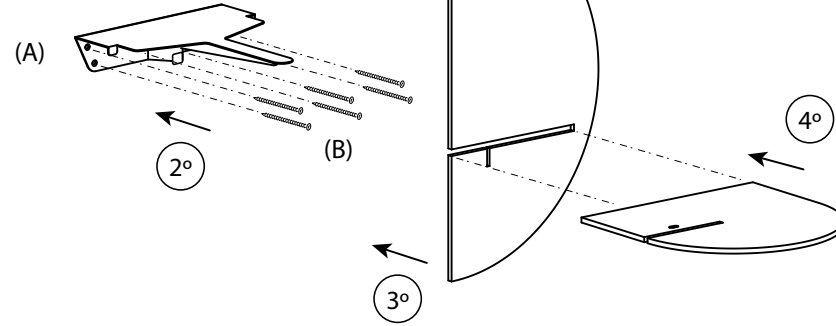

5° Placez la pièce en "U" entre le mur
et le panneau arrière.
Marquez les trois trous à l'aide
d'un crayon

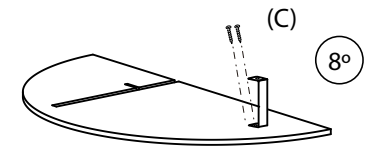
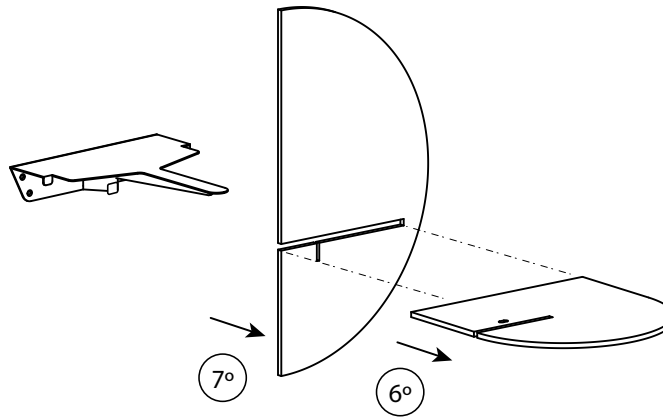

8° Visser la pièce en U au panneau
arrière (x2 vis)

9° (A)

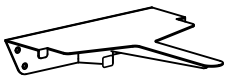

Faire le trou dans le mur

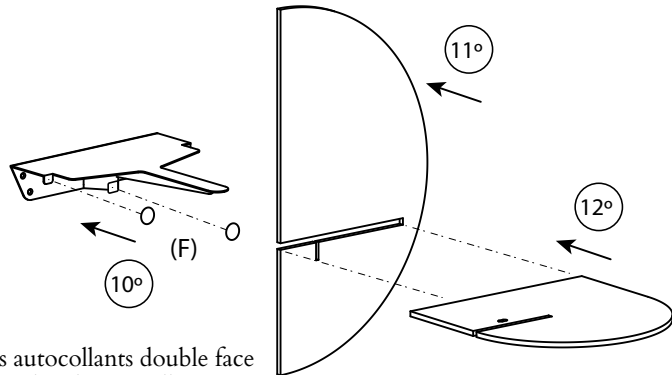

10° Placez les autocollants double face
(x2) sur le rabat métallique

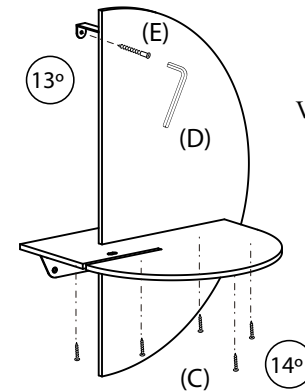

13° Visser la pièce en "U" au mur
à l'aide de la clé Allen.
Visser le plateau de table

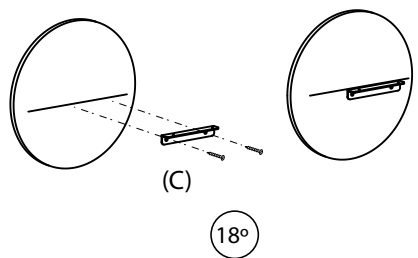
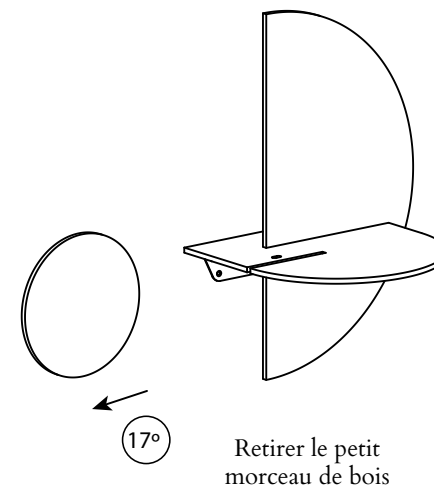
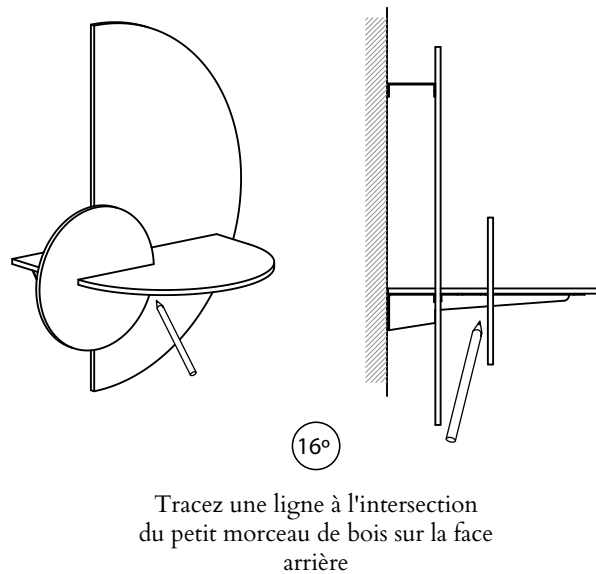
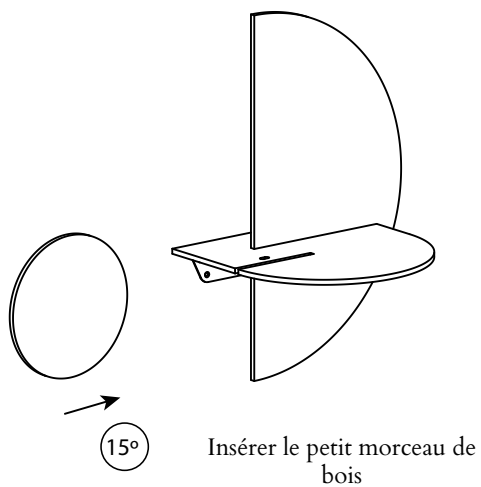

Visser la plaque métallique en L en suivant la ligne marquée

