

# Alba Floating nightstand

## *MONTERINGSVEJLEDNING*

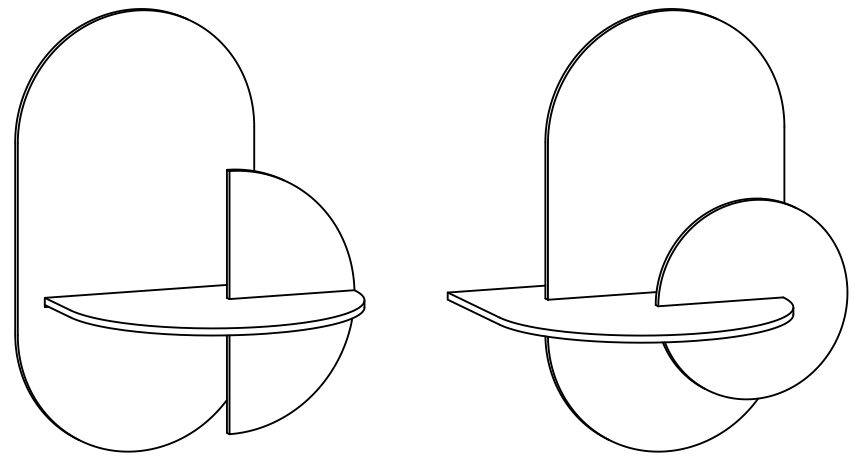

**Woodendot**

LIVE DESIGN

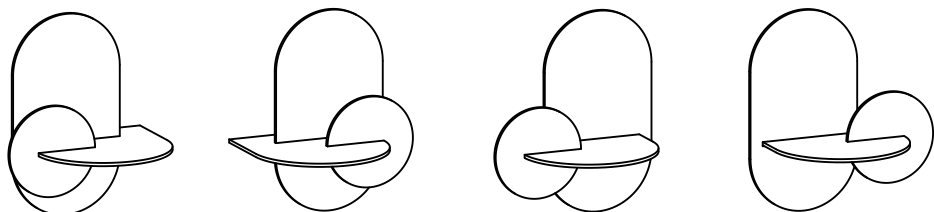

### 4 FORSKELLIGE MULIGHEDER

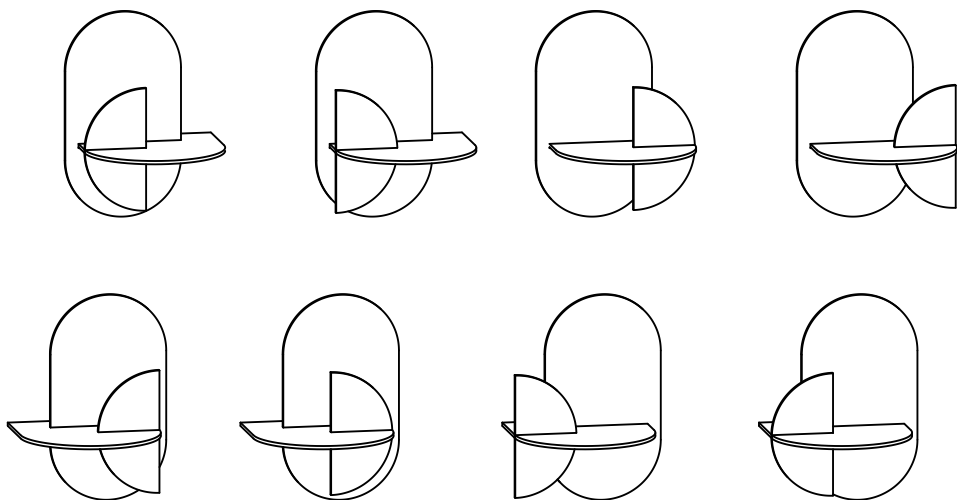
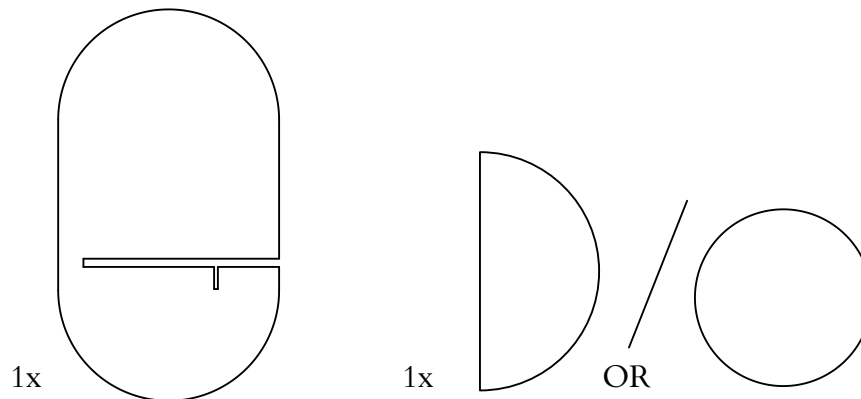

### 8 FORSKELLIGE MULIGHEDER

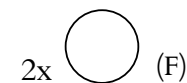
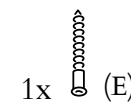
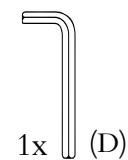
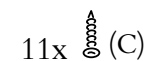
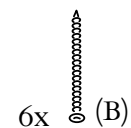
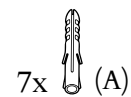
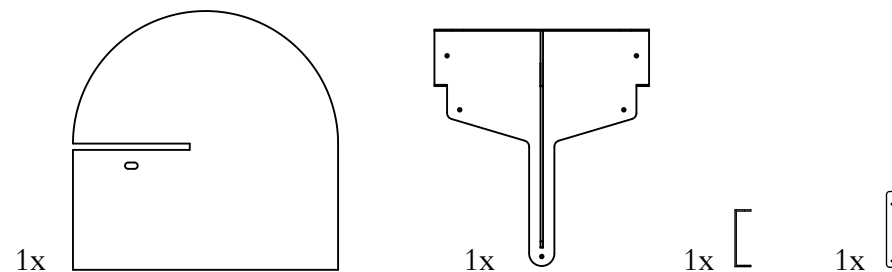

Vi anbefaler to personer til installationen



Du skal bruge en håndboremaskine til væghullerne



Det nødvendige bor er  $\varnothing$  6 mm eller 15/64"  
Dybde af hul i væg: 50 mm / 1,96"

For at bestemme den nøjagtige dybde af huller skal du måle 50 mm / 1,96" på boret og placere tape rundt om det for at markere afstanden. Stop med at bore, når det når denne dybde.

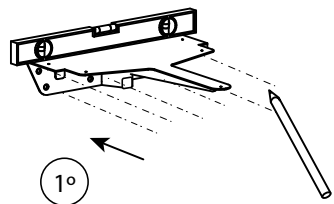

Brug niveauværktøjet  
Marker hullerne med en blyant.

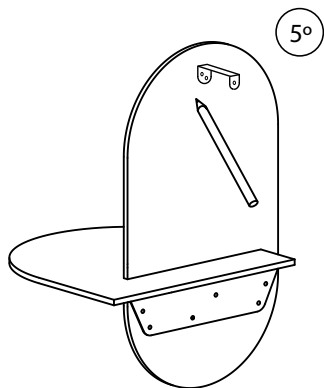
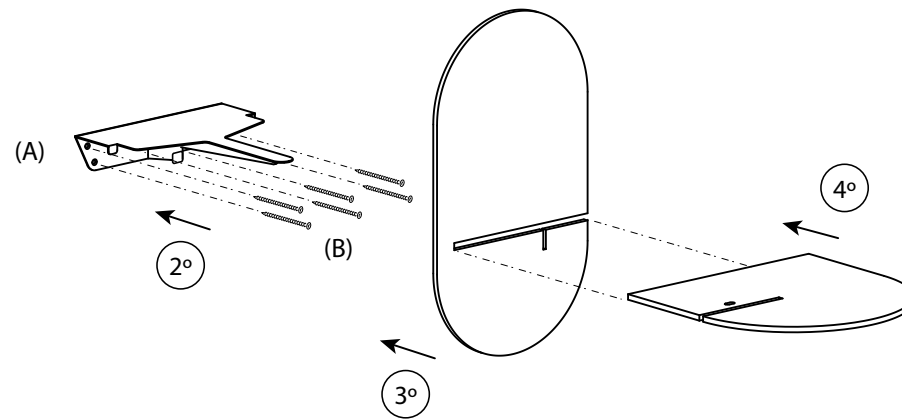

Placer "U"-stykket mellem  
væggen og bagpanelet.  
Marker de tre huller med en  
blyant.

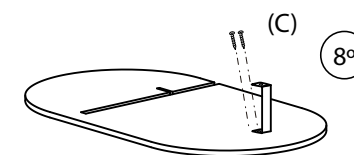
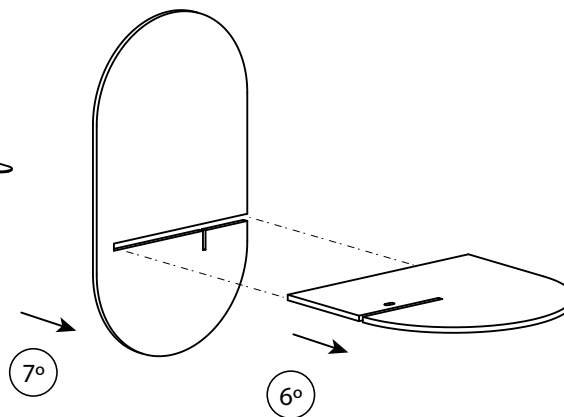
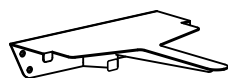

Skru "U"-stykket til bagpanelet  
(x2 skruer).

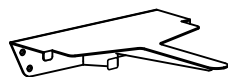

Lav hullet i væggen.

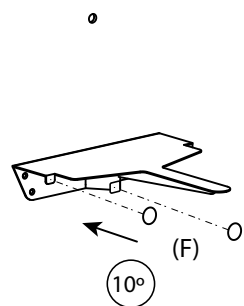

Placer den dobbeltsidede  
klæbemidler (x2) på metalklappen.

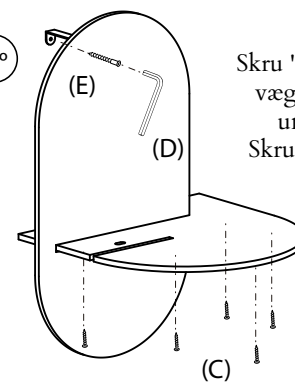
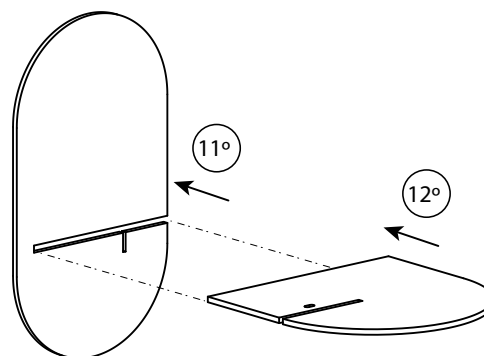

Skru "U"-stykket fast på  
væggen ved hjælp af  
unbrakonøglen.  
Skru borddækslet fast.

