

Alba Floating nightstand

INSTRUCTIONS D'ASSEMBLAGE

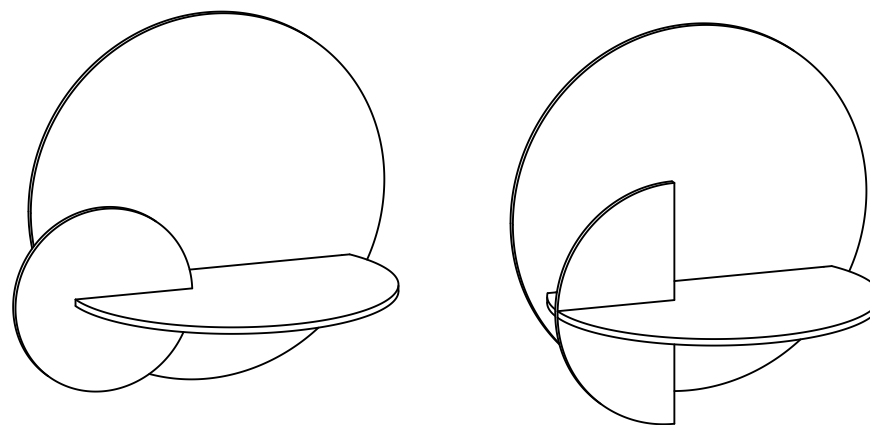

Woodendot

LIVE DESIGN

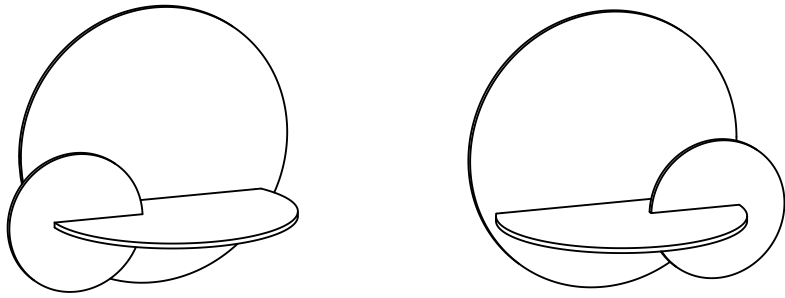

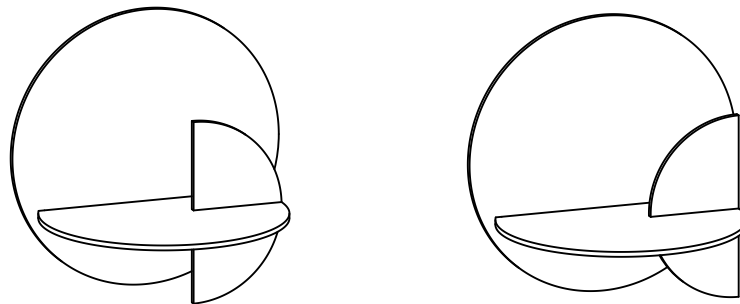
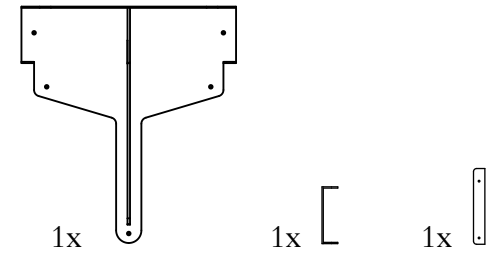
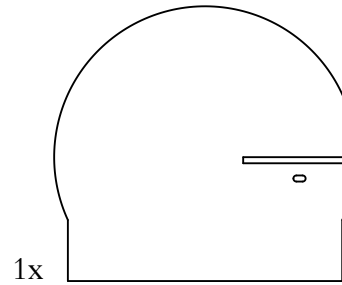
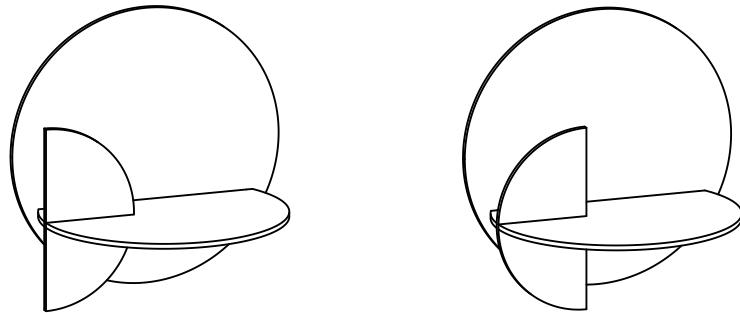
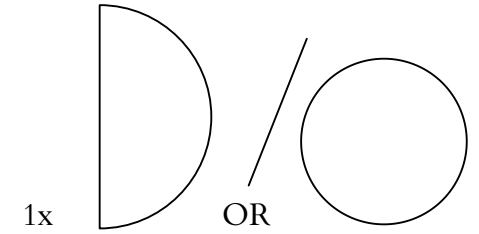
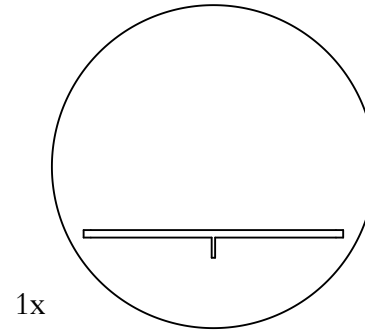

2 POSSIBILITÉS DIFFÉRENTES

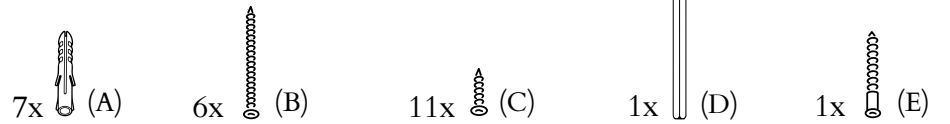

4 POSSIBILITÉS DIFFÉRENTES



 Nous recommandons deux personnes pour l'installation

 Vous aurez besoin d'une perceuse à main pour les trous dans le mur

 La mèche nécessaire est Ø 6 mm ou 15/64"
Profondeur du trou dans le mur: 50 mm / 1.96"

Pour que le trou soit exactement à la bonne profondeur, mesurez 50 mm / 1,97" sur la mèche et placez un ruban adhésif autour de cette mesure pour marquer le trou. Arrêtez de percer lorsque vous atteignez cette profondeur.

