

Product information sheet DALAGO 8

Item no. 516629

Benefits



- Large bowl offers a lot of space for food preparation and rinsing
- Continuous tap ledge protects the worktop from water drops
- Modern design with clear lines
- Functional accessories optional available

Colours



Available colours:

- black
- anthracite
- rock grey
- volcano grey
- alu metallic
- white
- soft white
- tartufo
- coffee

SILGRANIT anthracite

Scope of supply

- waste kit with space-saving pipe
- 3 ½" basket strainer with drain remote control (rotary switch)

Details

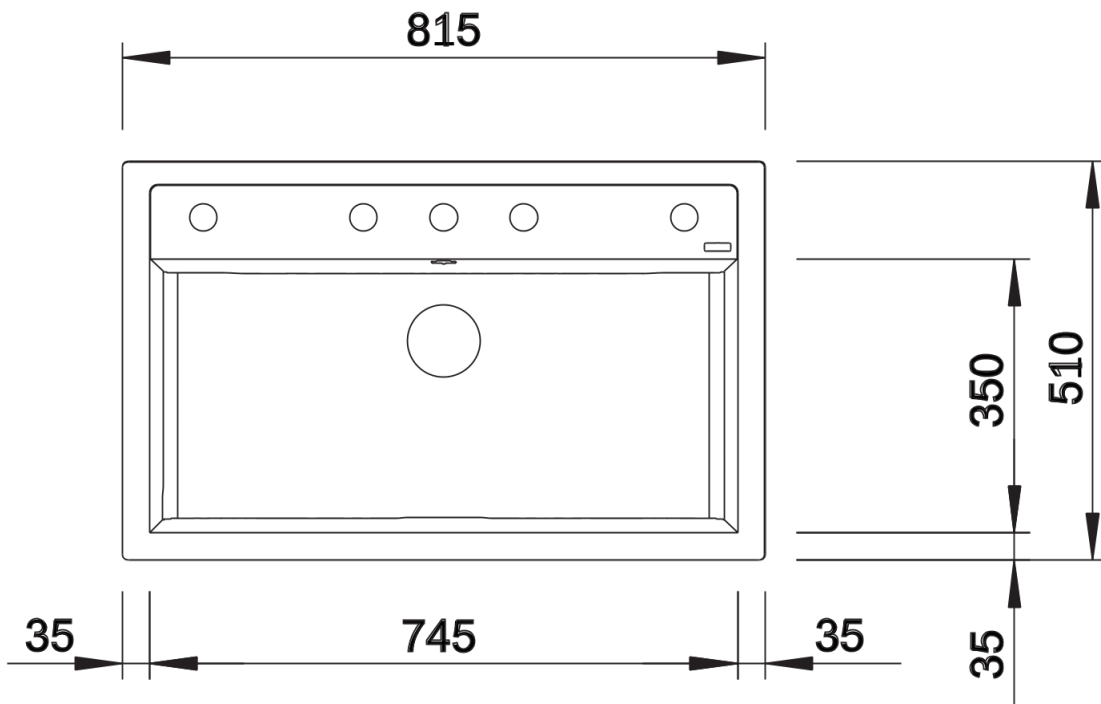

Top view

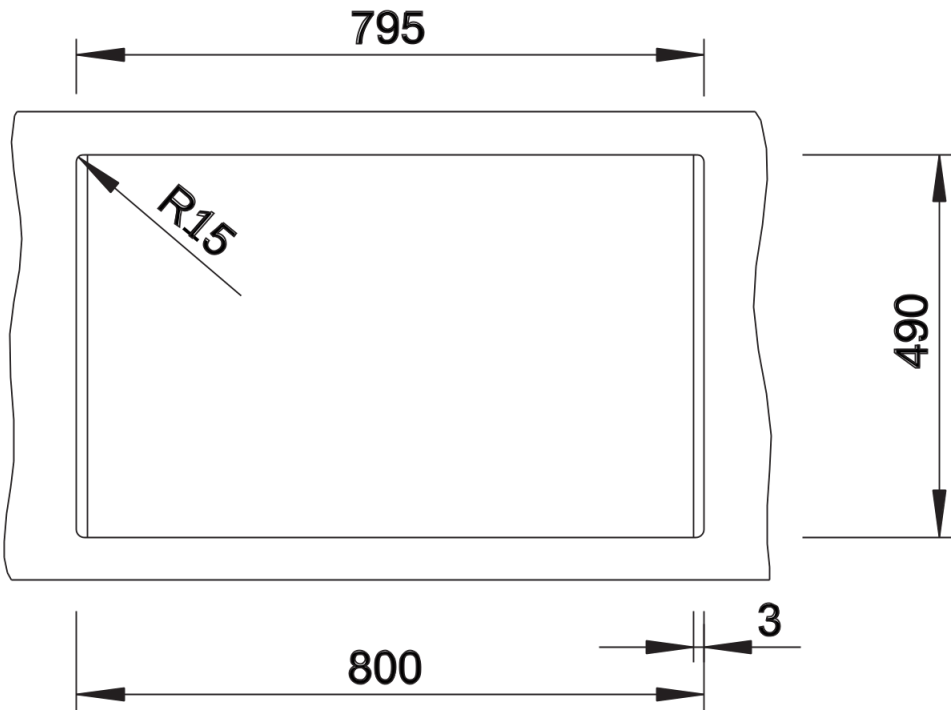

Cut-out

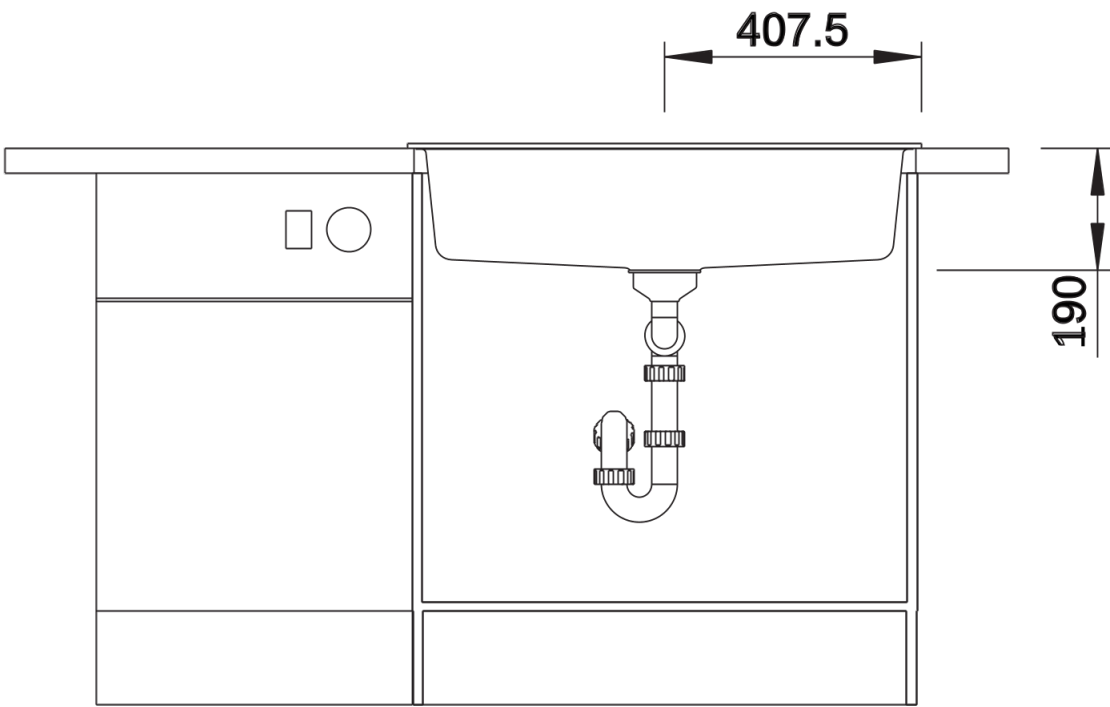

Front view

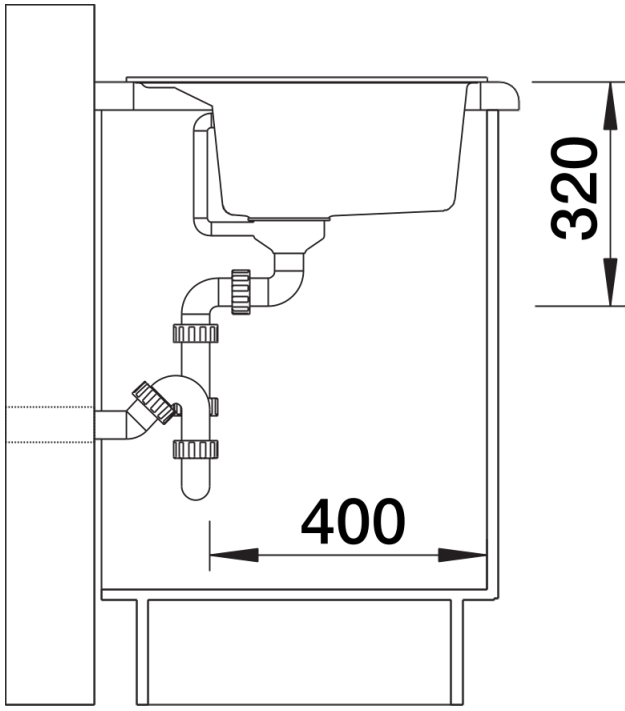

Side view