

Anleitung / Manual

LAS II DOUBLE

DE + US

P-01-083

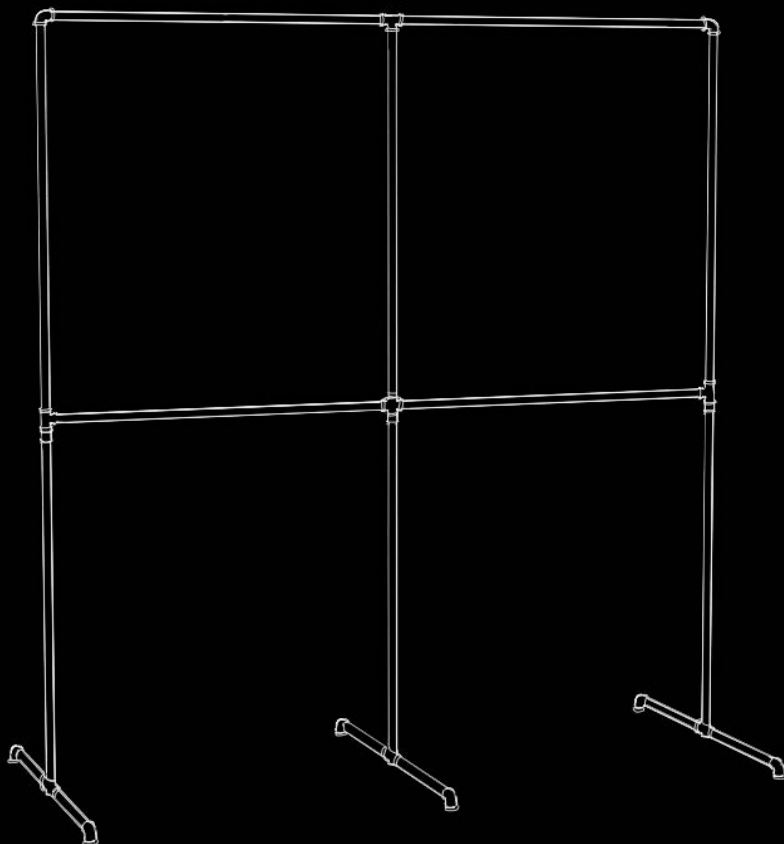

HOW-TO
VIDEO



pamo.



! Warnhinweise beachten!
Observe warnings!



2 Personen /
2 persons



Werkzeug /
Tools



Unterlage verwenden /
Use Underlay

Lieferumfang / Scope of delivery



E × 8



F × 3



O × 2



4mm



L × 1

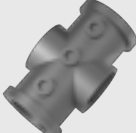

P × 4



G × 6



X25 × 6



X93 × 10

Bitte prüfen Sie alle Teile auf Transportschäden oder Macken.

Sollten Sie Transportschäden entdecken ersetzen wir sofort die entsprechende Teile.

Please check the parts for transport damage or scratches.

If you find any damage, contact us and we will replace the defective parts.

1

E



X25

X 6



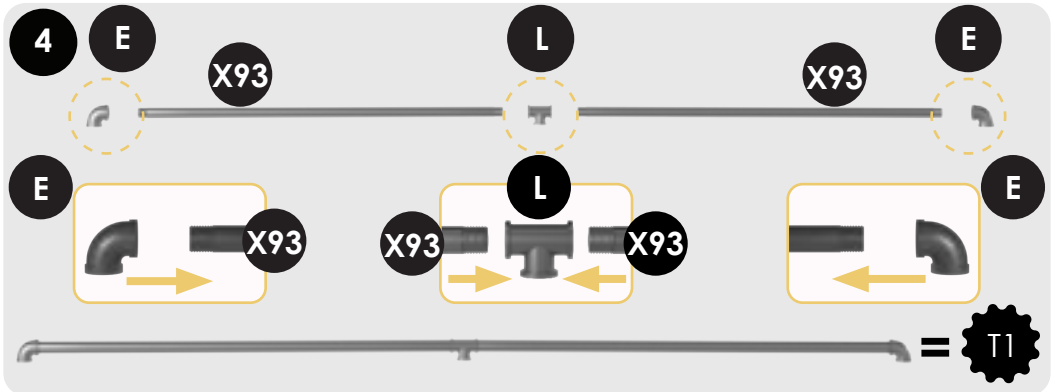
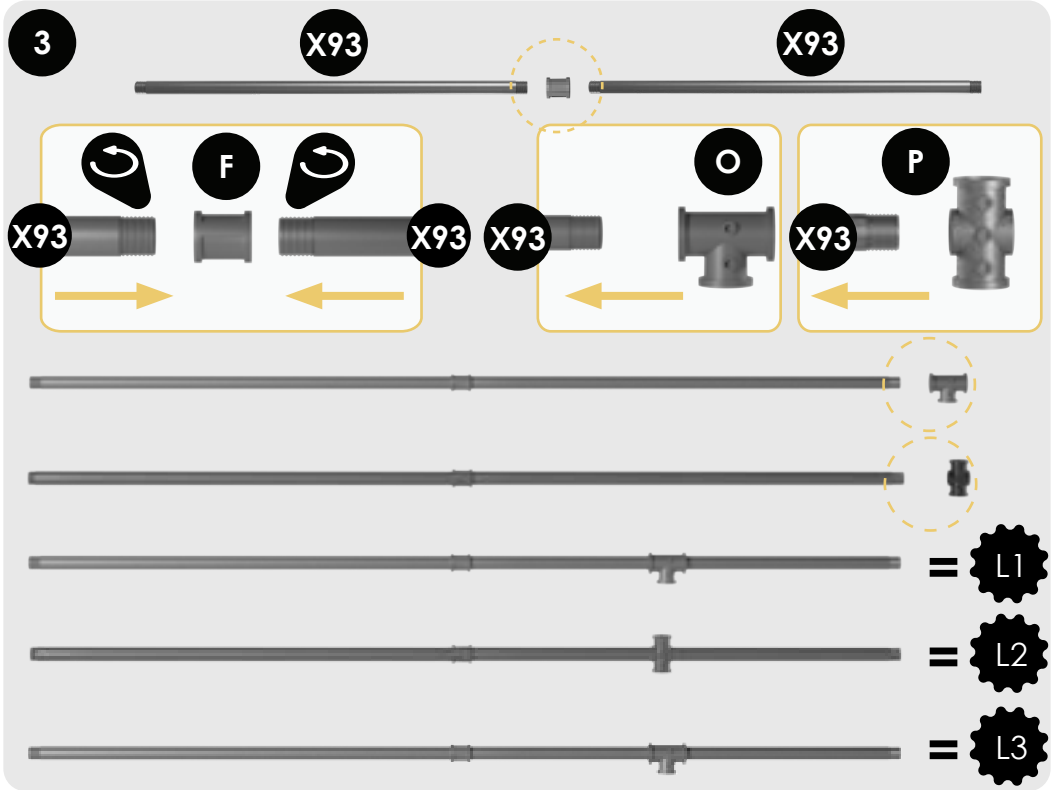
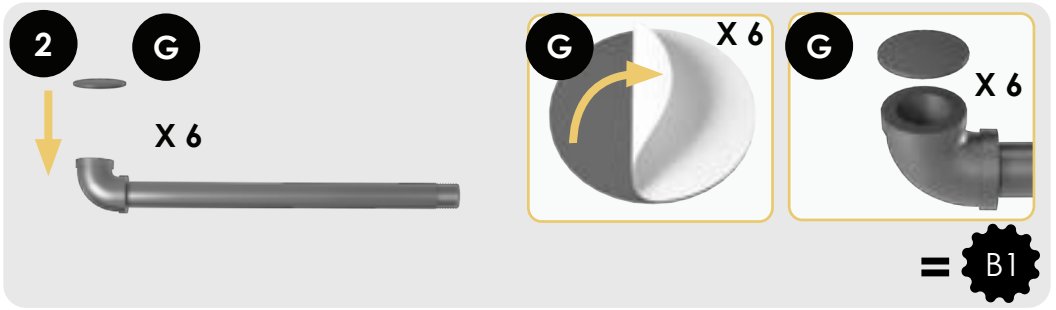

5

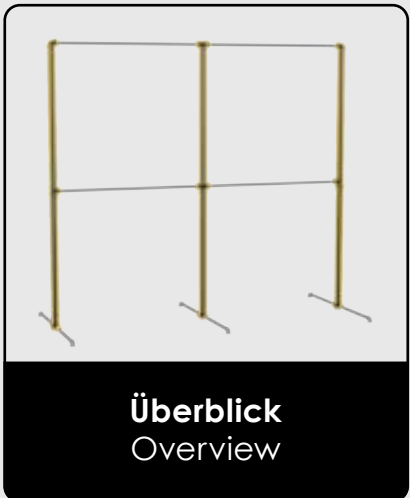
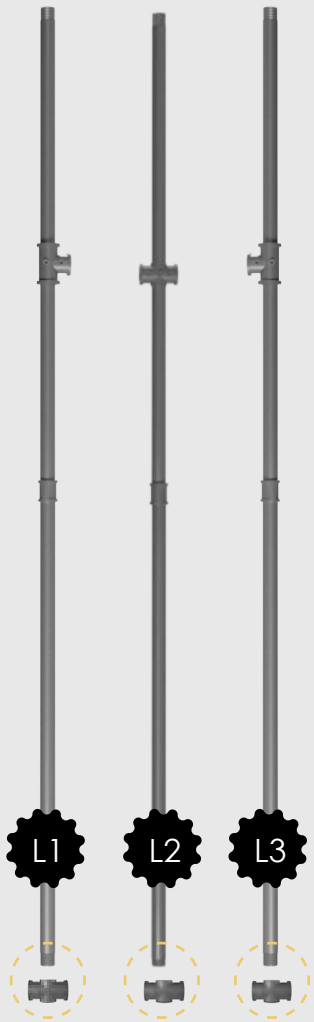

Überblick
Overview

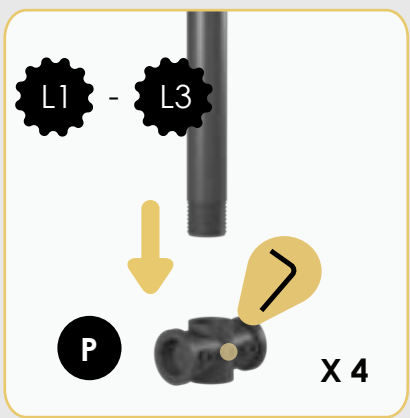

6

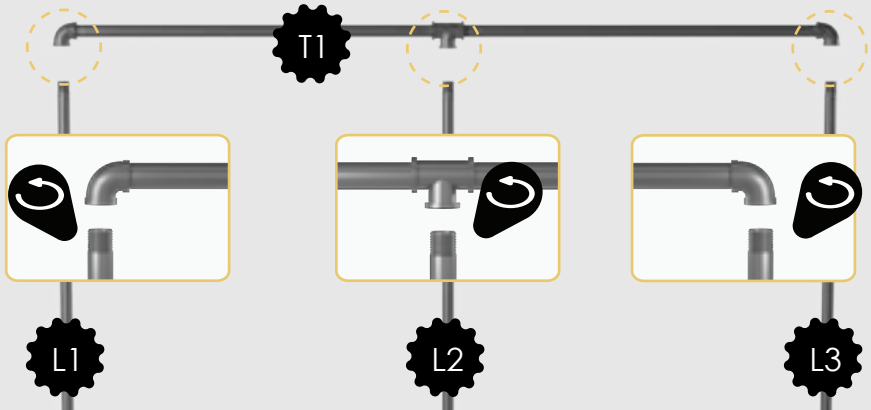

7

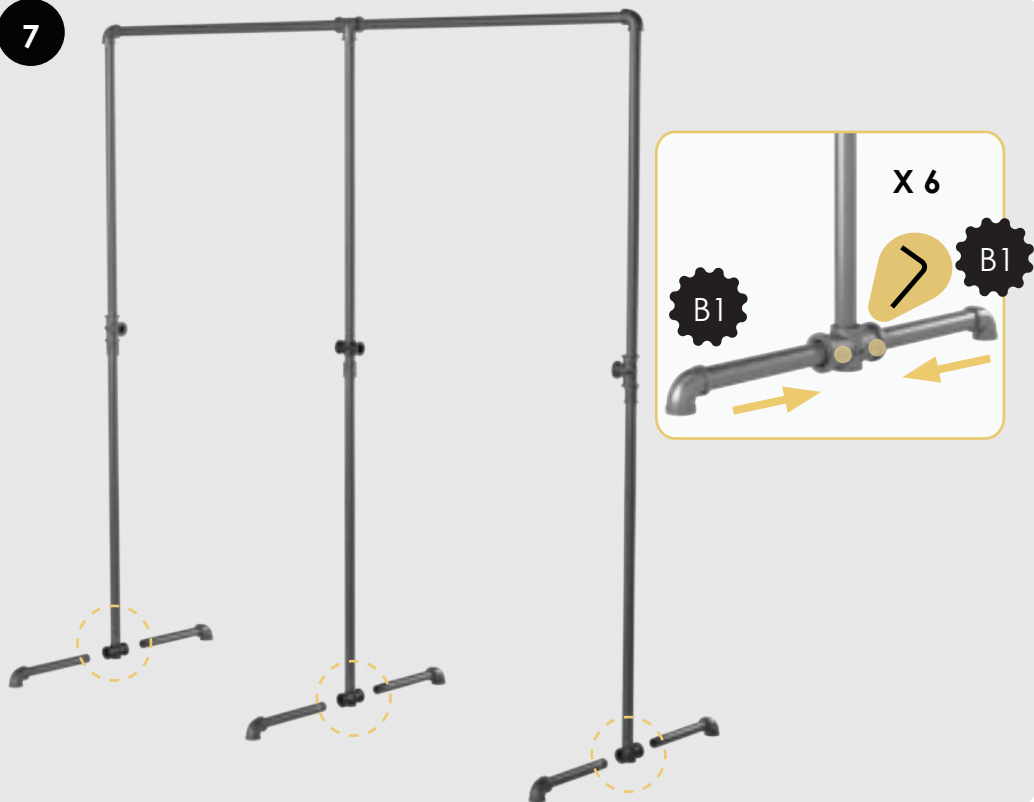

8

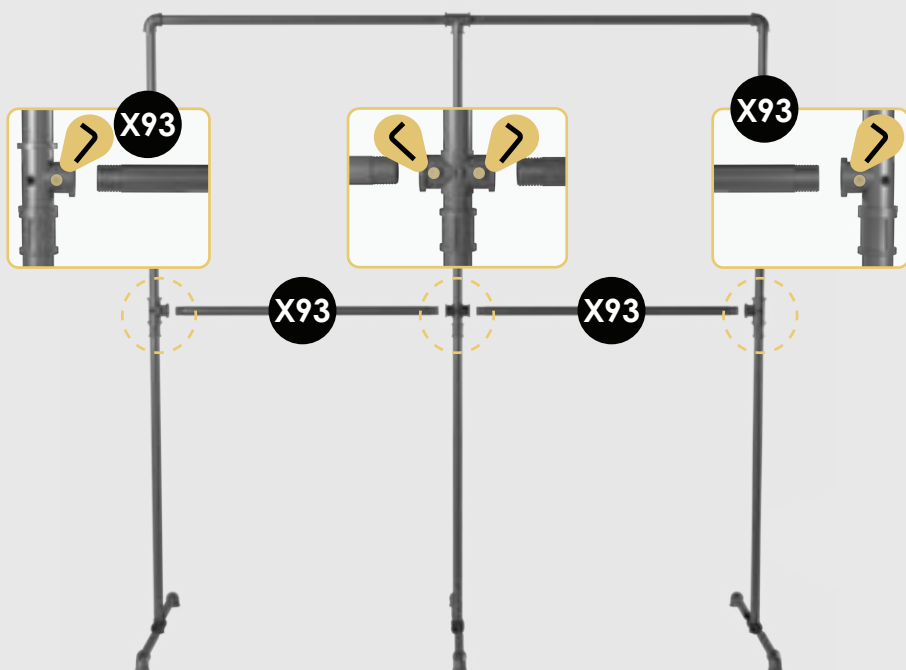

9

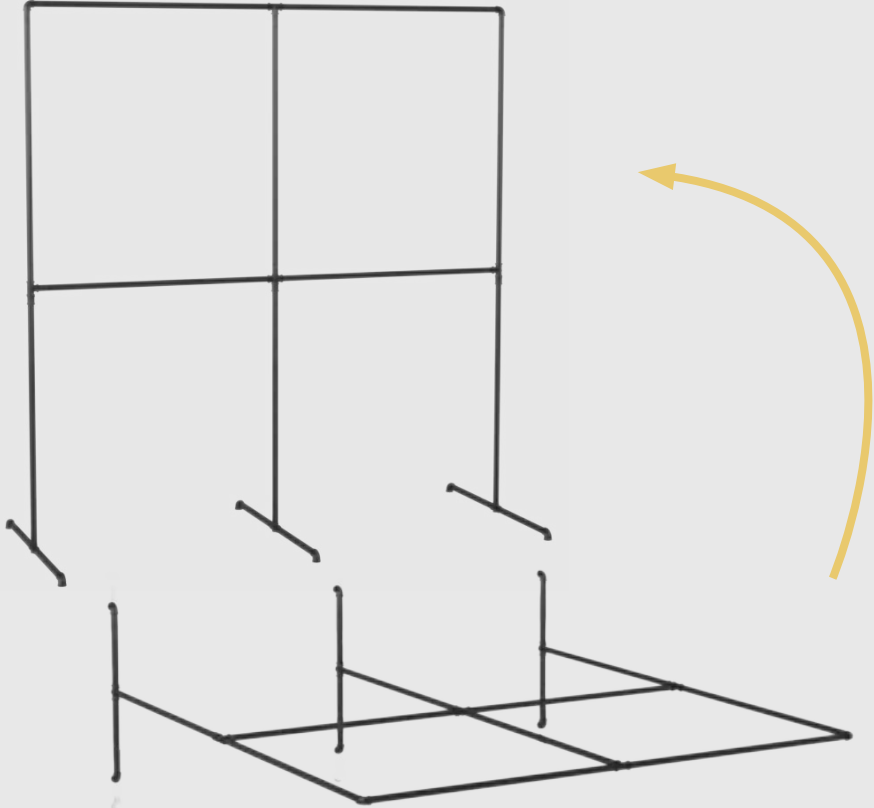

10

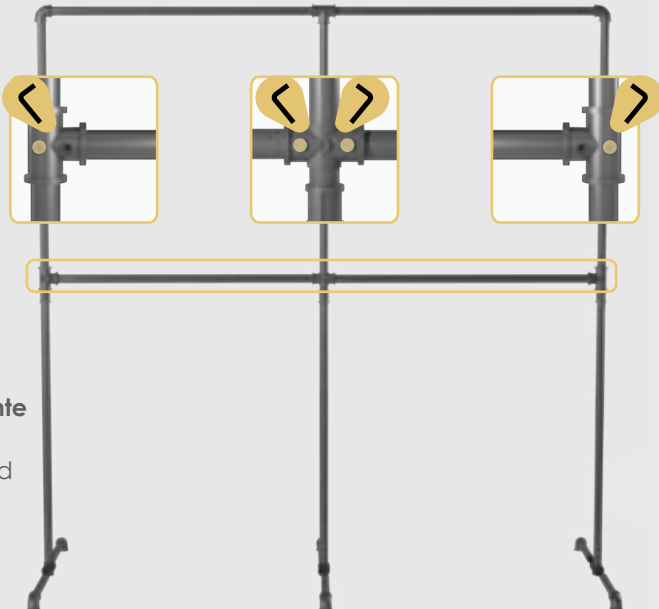

**auf die gewünschte
Höhe festziehen**

tighten on desired
height.

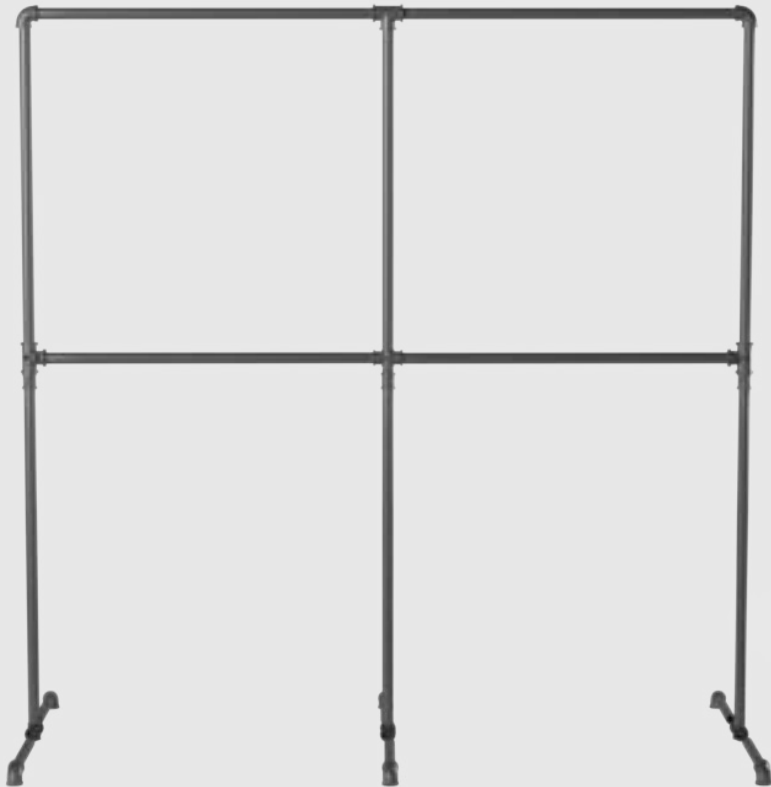

Wichtige Hinweise *Important notes*

Nur zur Nutzung als Kleiderstange gedacht

Intended only for use as a clothes rail

Die maximale Belastung pro Querstange beträgt 25 kg.

The maximum load per crossbar is 25 kg (55lbs).

Bei unsachgemäßer Nutzung übernimmt SaleLab keine Haftung oder sonstige Verantwortung für Sach- oder Personenschäden entstehen.

SaleLab assumes no liability
or other responsibility for property damage or
personal injury resulting from improper use.



Pflege / care

Pflege dein pamo-Produkt:

Unsere Produkte sind auf eine sehr lange
Haltbarkeit ausgelegt. Um lange Freude an ihnen zu
haben, halte dich bitte an unsere Pflegehinweise.

- Mit einem feuchten Tuch reinigen. Nur Wasser
oder sanfte Reinigungsmittel
verwenden. Entferne Seifenreste sofort mit einem
sauberen, trockenen Tuch.
- Keine Scheuermilch oder Scheuerschwämme
verwenden, da diese die
Oberfläche zerkratzen können.

Care for your pamo-product:

Our products are designed for a very long durability.
To enjoy them for a long time please follow our care
instructions.

- Clean with a damp cloth wrung in a solution of
water and a neutral
detergent. Remove soap residue immediately
using a clean, dry cloth.
- Avoid using scouring cream or scouring pads,
as they may scratch the surface.

**Viel Spaß mit deinem
pamo.-Produkt!
Enjoy your pamo.-product!**

Kontakt / contact
Wir helfen Dir gerne:
We are happy to help you:

EU

 support@pamo-design.de
 www.pamo-design.de

US

 support@pamo-design.com
 www.pamo-design.com

pamo.

Europe

SaleLab GmbH | Haydnstraße 28
88284 Wolpertswende | DE

USA

SaleLab Inc | 444 Brickell Avenue
Suite 700 | Miami, FL 33131 | USA