

12**13****14****15****16**

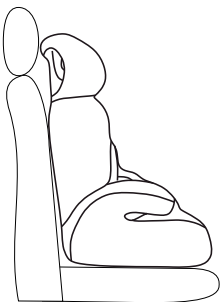

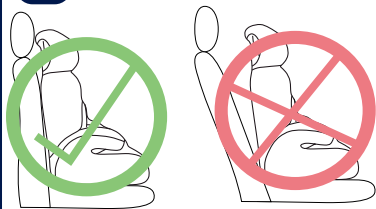

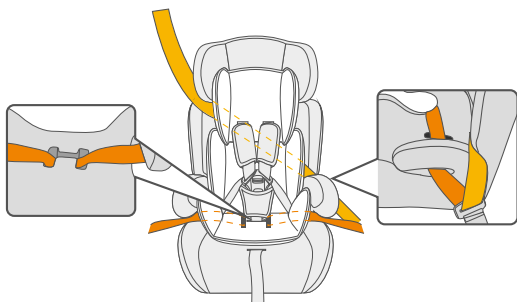

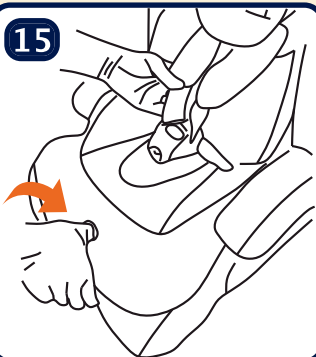
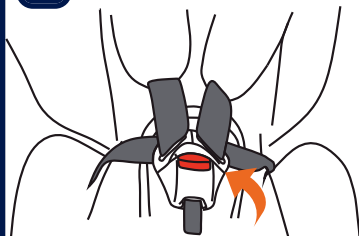
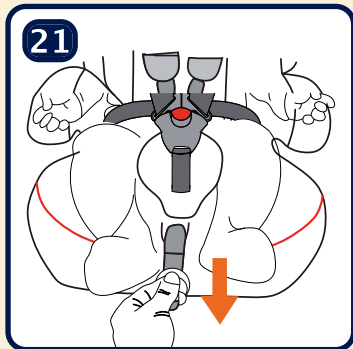
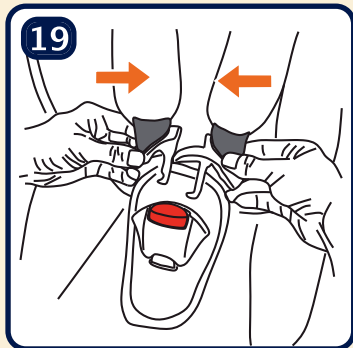
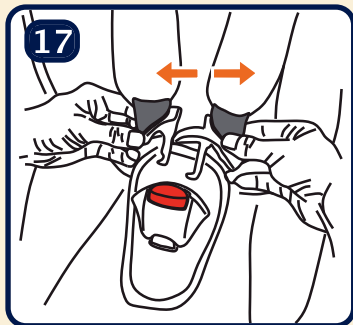
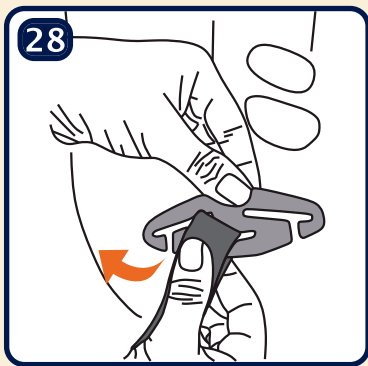
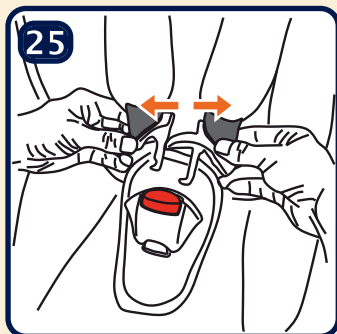
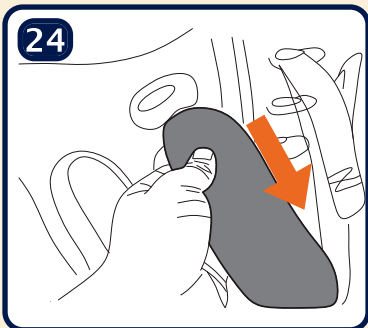
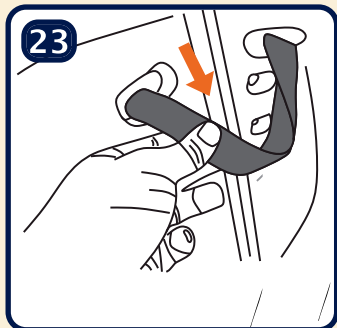
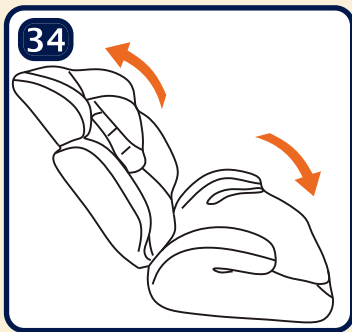
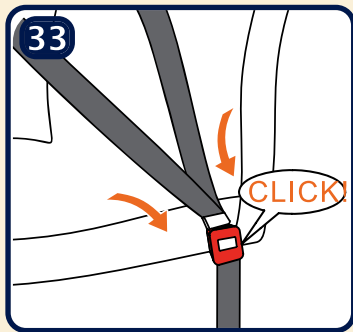
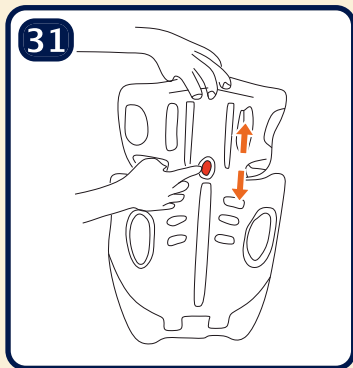
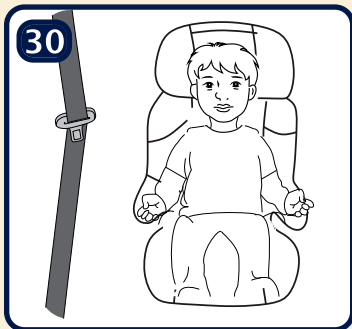
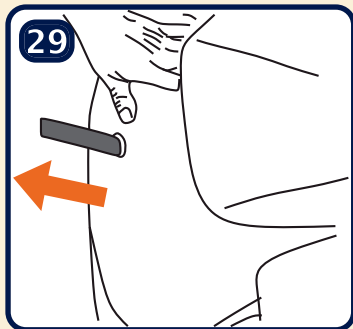
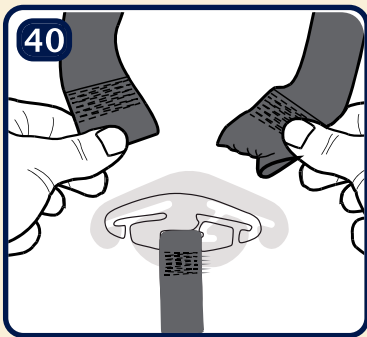
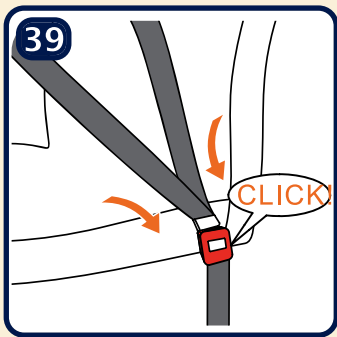
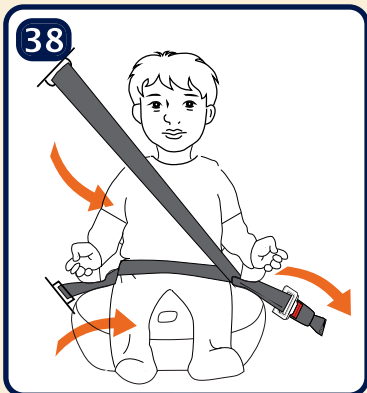
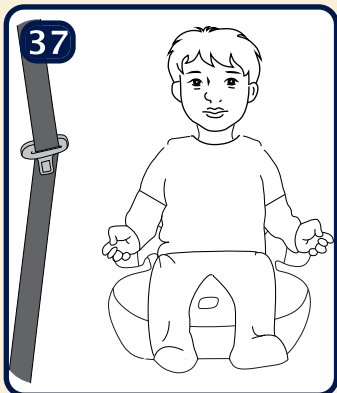
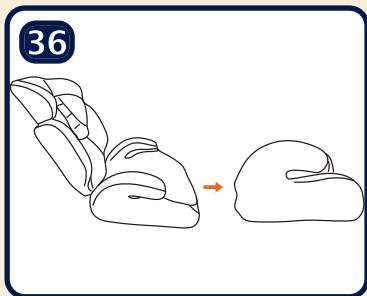
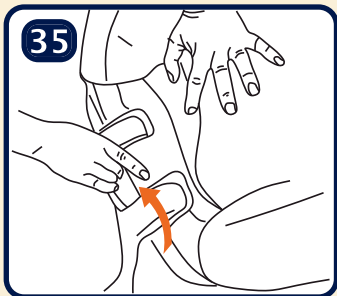

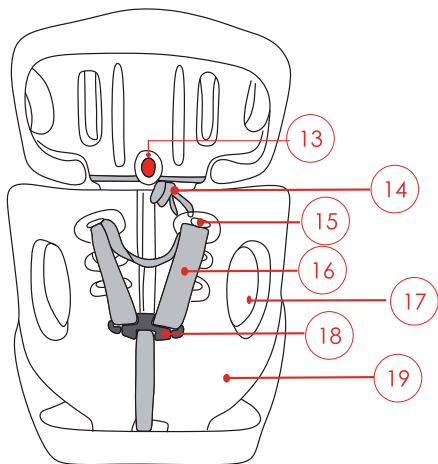
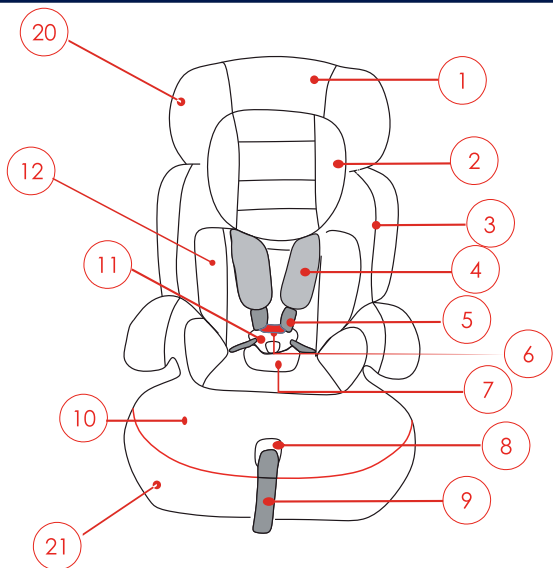



INSTRUCTIONS FOR USE

IMPORTANT! READ THE INSTRUCTIONS CAREFULLY AND KEEP FOR FUTURE REFERENCE.

Your child's safety could be at risk if you do not follow the instructions. **IMPORTANT!** Only use the product for the purpose that it was designed for. Should the product be used for any other purpose the manufacturer declines all responsibility. Never use replacement parts other than those supplied or approved by Cam Il Mondo Del Bambino, as this could cause damage to your product and make it unsafe. **IMPORTANT!** CAM IL MONDO DEL BAMBINO S.P.A reserve the right to alter or modify any product for technical or commercial reasons without prior notice. **WARNING!** Never leave the child unattended in the car seat! **WARNING!** This car seat must be replaced in case of impact caused by car accident. This is a "UNIVERSAL" car seat, and is approved to ECE Regulation R 44, for general use in motor vehicles. This car seat will fit most, but not all motor vehicles. A correct fit is likely if the vehicle manufacturer has declared in the vehicle hand book that the vehicle is suitable to accept a "UNIVERSAL" child restraint for this age group and weight. This car seat has been declared as "UNIVERSAL" under more stringent test conditions than those applied to earlier designs which do not carry this notice. In case of doubt please contact your retailer or the manufacturer. This car seat can only be used if your vehicle is fitted with a 3 point safety belt approved to UN/ECE Regulation No 16 or other equivalent standard. The safety of your car seat can only be guaranteed if the instructions have been followed correctly and the car seat has been fitted accordingly. Do not place unrestrained objects on the rear panel or rear seat of the vehicle, as this could cause injury in case of braking or an accident. Ensure that all luggage or objects that could cause a potential hazard in the case of an accident are firmly secured. All passengers should be aware of how to release the child from the car seat in case of danger or an accident. the car seat should be replaced immediately if involved in an accident. Pay particular attention, that neither the car seat, nor any of it's parts, become trapped or crushed, in doors or mechanism of the motor vehicle. The safety belt used must be pulled tight to remove any slackness, and the car seat harness, must be adjusted correctly to fit the child's body. Ensure the the belts are not twisted in any way! Pay attention to the fitting of the abdominal belt, ensuring that it is positioned low down, to ensure that the pelvis is held firm and correctly protected. Even when travelling without a child, the car seat must be fully restrained at all times. Do not use the car seat without the fabric upholstery covering. The fabric upholstery must not be replaced with any other than original parts, or those recommended by the manufacturer, as this constitutes an integral part of the restraining system. The upholstery can be washed in warm water (max 30°), with a mild neutral detergent. Do not tumble dry, do not iron, and do not use solvents. Should any problems arise during the fitting, or use of this product, contact the manufacturer. Please note that group 1-2-3 stage car seats can be used on the front seat and are exempt from the regulation of not being fitted when an airbag is active, as per Regulation ece R 44. We would however recommend that this car seat only be used on the rear seat of your vehicle. For safety reasons, this instruction booklet, must be kept in the pocket situated at the rear of the car seat at all times. Use of the car seat is subject to standard ece R 44. certain limitations prevail over this standard and are imposed by local or national laws. Do not leave your child unattended in the car seat. Do not use on front seats fitted with front airbags. Do not use second-hand products, because the background of the product is not known. Always place the pads correctly on the child's chest as they are essential for his safety. Do not lubricate the moving parts of the car

seat. Do not leave the car seat in the car under the sun: the plastic and metal parts could overheat. Cover the car seat if the car is parked under the sun. Do not remove the logos of the product to avoid damaging the fabric. Most accidents happen in town: always use the car seat even for short journeys. Before buying the product, always check that the car seat can be fitted properly in your car. All passengers must wear seat belts. Stop often for breaks during long journeys so that your child is free to move about. Never allow your child to play with the harness or the buckle on the car seat. Observe the highway code of your country.

USE IN A VEHICLE

Installation

1. Group 1, for children weighing between 9 and 18 kg.: forward facing installation.

2. Groups 2 and 3, for children weighing between 15 and 36kg: forward facing installation.

3. Do not fit the car seat on seats provided with two-point seat belts. This car seat can only be fitted on seats provided with a 3-point seat belt standard approved according to UN/ECE Regulation N. 16 or an equivalent.

4. Methods of installation:

YES - Forward facing

NO - Rearward facing

NO - On seats with two-point seat belts. Use of the two-point seat belt increases the risk of injury quite substantially in the event of an accident.

YES - On a seat with a three-point seat belt. The 3-point safety belt must be standard approved according to Regulation UN/ECE N. 16 or equivalent. (Standard approval is marked by the symbol showing a letter E in a circle on the label of the belt).

NO - On front seats

YES - On one of the side back seats

YES - On the middle back seat if it is fitted with a 3-point seat belt, but not on the middle back seat if it has a 2-point seat belt (consisting of the lap belt only as fitted in some older cars).

NO - On a seat facing sideways.

NO - On a seat facing rearwards.

5. Identify the components of the car seat before using it. **Pay particular attention to figure 5.**

1. Headrest

2. Headrest insert cushion

3. Backrest cover

4. Harness pad

5. 5-point harness

6. Buckle opening button

7. Buckle pad

8. Spring adjuster

9. Adjusting strap

10. Seat

11. Buckle

12. Backrest insert cushion

13. Headrest height adjustment mechanism.

14. Headrest strap

15. Slots for adjusting the height of the 5-point harness

16. 5-point harness

17. Passage of car seat belts

18. Metal hook

19. Backrest

20. Headrest cover

21. Seat cover

Check the height of the harness straps. The straps must be adjusted in the position closest to the child's shoulders. If this is not the case, adjust the height of the straps before using the car seat.

To change the position of the harness straps:

6. Press the adjuster and at the same time pull both of the car seat safety straps. Do not pull the pads wrapped around the straps.

7. Release one safety strap from the metal hook located behind the car seat backrest.

8. Pull out the safety strap from the backrest.

9. Thread the safety strap into the slot in the backrest at the required height.

10. Refasten the safety strap to the metal hook.

Repeat the same procedure with the other strap.

11. Pull the adjuster strap to tighten



INSTRUCTIONS FOR USE

the car seat safety straps.

Fitting the car seat in the vehicle.

12. Position the car seat on the seat of the vehicle so that it rests fully on the seat and against the backrest.

Caution:

13. Place the vehicle seat in an upright position before fitting the child car seat. Do not fit the car seat on reclined seats. Check that the safety belts are not twisted. The backrest of the child car seat must rest fully against the backrest of the vehicle seat, without leaving any space in between.

GROUP 1, FROM 9 TO 18 KG.

Caution: The points where the seat belts pass are marked in red. Do not pass the car seat belts in any positions other than those shown.

14. Pass the diagonal part of the car seat belt on the top part of the backrest.

Pass the lap car seat belt under the armrest of the seat of the child car seat.

Pass both seat belts through the slots in the backrest of the child car seat.

Pass both seat belts under the armrest of the seat of the child car seat.

Fasten the car seat belt; a "click" should be heard.

Tighten the car seat belt well, make sure that it is not twisted and that it rests securely under the armrests of the car seat.

15. Press the adjuster and at the same time pull both the safety straps of the child car seat.

16. Press the red button on the buckle to open it.

17. Move the safety straps and rest them at the sides of the car seat.

18. Sit your child in the car seat.

Position the car seat safety straps on the child's shoulders.

19. Bring the tongues together and insert them into the buckle. A click is heard indicating the harness has been fastened properly.

20. Position the pads on the child's chest and shoulders.

21. Pull the adjuster strap to ensure the harness fits the child snugly.

Caution: Every so often during the journey check that your child has not loosened himself from the car seat.

A safety harness that is tightened properly does not allow an excessive amount of play between the strap and the car seat.

The car seat safety straps must fit snugly, must not fall off the child and must not be twisted. The straps must not be excessively tight across the child or force him to adopt an unnatural position.

Check periodically that the straps remain taut over the shoulders. Adjust the tension if necessary.

How to release your child

Press the adjuster and at the same time pull both the safety straps to loosen them. Press the red button on the buckle to open it. Remove the safety straps and move them away from the child.

GROUPS 2 AND 3, FROM 15 TO 36KG.

Caution: remove the safety harness before using the car seat for groups 2 or 3.

How to remove the car seat safety harness:

22. Release both safety straps from the metal hook.

23. Remove the straps from the backrest.

24. Remove the pads from the backrest.

25. Press the red button on the buckle to open it.

26. Lift the cover of the seat and remove the harness completely.

27. Pass the metal clip of the buckle through the slot in the seat and remove the buckle from the car seat.

28. Release the metal hook of the strap.

29. Remove the adjuster strap.

How to position your child.

Position the child car seat on the seat of the vehicle so that it rests fully on the seat and against the backrest.

Place the child car seat on the seat of the vehicle in a forward facing position.

30. Adjust the height of the headrest.
31. To raise the headrest, press the button and pull the headrest upwards; vice versa to lower it. A click will be heard indicating the change from one position to another.

Caution: The correct positioning of the headrest is essential for the safety of your child. Do not under any circumstances remove the headrest. Sit the child in the car seat.

Caution: The points where the seat belts pass are marked in red. Do not pass the car seat belts in any positions other than those shown.

32. Position the diagonal car seat belt on the child's chest and pass it under the armrest of the car seat on the side opposite the belt retractor.

Thread the belt into the belt guide located under the headrest.

Pass the lap belt under the two armrests of the car seat.

Tighten the car seat belt well, make sure that it is not twisted and that it rests securely under the armrests of the car seat.

33. Fasten the car seat belt; a "click" should be heard.

Caution: Every so often during the journey check that your child has not loosened himself from the car seat.

GROUPS 2 AND 3 WITHOUT THE BACKREST, FROM 15 TO 36KG.

34. Push the backrest right back.
35+36. Hold the base firm with one hand and remove the backrest from the seat.

How to fit the car seat in the vehicle

Position the car seat on the seat of the vehicle so that it rests fully on the seat and against the backrest.

Caution: The points where the seat belts pass are marked in red. Do not pass the car seat belts in any positions other than those shown.

37. Sit the child in the car seat.
Position the diagonal car seat belt on the child's chest and pass it under the armrest of the car seat on the side opposite the belt retractor.

38. Pass the lap belt under the two armrests of the car seat.

Tighten the car seat belt well, make sure that it is not twisted and that it rests securely under the armrests of the car seat.

39. Fasten the car seat belt; a "click" should be heard.

Caution: Every so often during the journey check that your child has not loosened himself from the car seat.

How to remove the cover.

40. Release both the safety belts from the metal hook and remove them from the backrest.

Remove the headrest cover.

Remove the car seat cover.

CLEANING

Caution: The covers are an integral part of the car seat: the car seat cannot be used without the covers. The covers can only be replaced with original parts.

The cover can be hand washed in lukewarm water (max. 30°C) using mild soap. Do not spin, do not iron and do not use solvents. Follow the washing instructions shown on the label of the cover.

Wash the plastic parts with lukewarm water and soap. Do not use aggressive substances.

The safety harness can be removed and washed with lukewarm water and soap. **Caution:** do not remove the buckle tongues from the harness.

41. Spare parts

1. Headrest
2. Headrest insert cushion
3. Backrest cover
4. Harness pad
5. 5-point harness
7. Buckle pad
10. Seat
12. Backrest insert cushion
13. Headrest height adjustment mechanism
19. Backrest
20. Headrest cover
21. Seat cover
22. Instruction manual
23. Box/packaging