

BluBird®

INDUSTRIES INC.

**AIR | WATER |
PRESSURE WASHER
HOSES
HOSE REELS &
ACCESSORIES**



BluBird OIL SHIELD® **AVAGARD®** **BluSeal AG-LITE®** **BluShield®** **Rapid TIE®**
by BluBird by BluBird by BluBird by BluBird by BluBird

www.blubirdindustries.com



OUR GLOBAL PRESENCE

 Australia
 Austria
 Belgium
 Canada
 Denmark
 Finland
 Germany

 India
 Ireland
 Netherlands
 Norway
 Poland
 Scotland
 South Africa

 Spain
 Sweden
 Switzerland
 United Kingdom
 United States of America

BluBird®

TECHNOLOGY

BluBird Advantage

BluBird develops technologically sophisticated and innovative general purpose hoses and hose reels. Thanks to our 30 years of outstanding know-how in the industry that we are able to serve a broad range of customer requirements in various countries, climates and working conditions. BluBird is the only manufacturer in the world that makes both hoses and retractable metal hose reels that are mounted on them.

BluBird products are manufactured in our ISO 9001:2015 facility to the highest quality standards and they last 3x longer than any other brands, offering a better return on investment for both residential and professional users.

BluBird Technology

BluBird Technology is a combination of 20 years of strong R&D and technical expertise. We continuously innovate extraordinary products because our customers deserve the very best. BluBird Technology separates the best from the rest. Our products are designed to offer the best of both worlds. Products that have an exceptional extreme weather flexibility, durability and lightweight comfort backed with an unmatched warranty. Our customers have come to believe in and trust our products and we strive to always give them the very best products possible.

Why BluBird?

We invest intensively and creatively in the development of new environment-friendly and technologically driven products backed by unmatched warranties. BluBird Rubber Air Hoses are the lightest, strongest, and most flexible hoses ever made. They perform in the most extreme conditions. Their cold weather flexibility is unmatched. These premium hoses are ozone, abrasion and kink resistant with 4:1 safety factor.

BluBird's BluSeal Rubber Water Hoses are 40% lighter than standard rubber water hoses and can handle hot water up to 212°F. They remain flexible in cold weather down to -50°F and up to +190°F. All BluBird products carry an unmatched 10-year warranty against manufacturing defects.

The BluBird OilShield air hose was awarded the 2016 Motor Magazine Top 20 Tool Award.

The BluBird BluShield Aramid Braided Pressure Washer Hose was awarded the 2020 Motor Magazine Top 20 Tool Award.

Visit www.blubirdindustries.com to learn more about our revolutionary products or contact sales@blubirdindustries.com for business inquiries.



INDEX

AIR

Pg no.

Rubber Air Hoses	5-16
PVC Air Hoses	17
Poly Air Hoses	18
Recoil Air Hoses	19
Snubber Air Hoses	20
Air Hose Reels	21-24
Swivel Mount	25
Air Blow Guns & Accessories	26-28

Water

Water Hoses	29-34
Water Hose Reels	35-37
Accessories	38-40

Pressure Washing

Pressure Washer Hoses	41-45
Pressure Washer Hose Reels	46-49
Pressure Washer Inlet Hoses	50
Accessories	51-54

Fuel Transfer

Fuel Transfer Hoses	56
Fuel Transfer Hose Reels	57

Material Handling

Rapid Ties	59
Wheel Chocks	60
Tool Bags	61-66



Ultra Light, Super Strong Air Hoses



Air Hoses



BluBird®

Safest | Strongest | Most Flexible

Best in Class!

40% Lighter than Traditional
Rubber Air Hoses
100% Rubber

BluBird hoses are 40% lighter, stronger and more flexible than other rubber hoses. BluBird hoses have superior cold weather flexibility down to -50°F and maintains its integrity up to +190°F making it a year round hose in most parts of the world. BluBird has an abrasion resistant external cover and high strength polyester reinforcement that prevents elongation and adds superior strength giving BluBird a 300 PSI working pressure and a 4:1 safety factor.

10
YEAR
WARRANTY

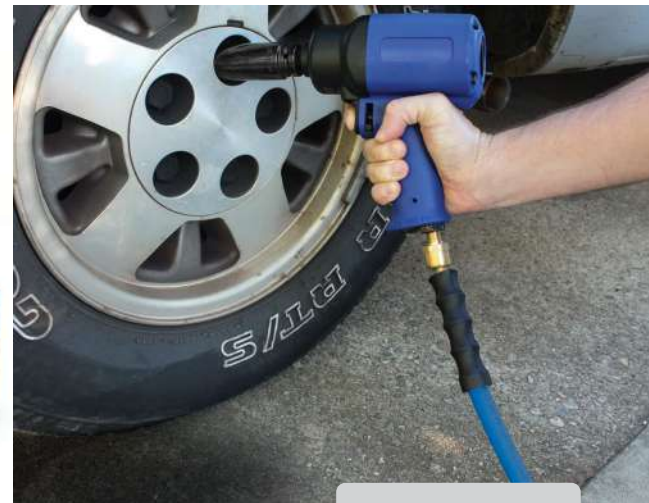

- Solid brass fittings that are superior to aircraft aluminium fittings
- High strength polyester braided reinforcement
- Maintains integrity under extreme weather conditions
- Ozone resistant
- Abrasion resistant
- Kink resistant
- 4-Finger grip bend restrictor for better use & easier control over the hose



**Heavy-Duty
Wrapped Finish**



YouTube



Flexibility in extreme conditions from -50°F to +190°F

300 PSI Working Pressure

1200 PSI Burst Pressure

4:1 Safety Factor

General Purpose Hoses

Model#	SKU#	Description	I.D	Length	Fitting
BB1425	10010315	Blubird Rubber Air Hose 1/4" x 25'	1/4"	25'	2 x 1/4" Male NPT
BB1450	10010322	Blubird Rubber Air Hose 1/4" x 50'	1/4"	50'	2 x 1/4" Male NPT
BB14100	10010310	Blubird Rubber Air Hose 1/4" x 100'	1/4"	100'	2 x 1/4" Male NPT
BB3825	10010361	Blubird Rubber Air Hose 3/8" x 25'	3/8"	25'	2 x 3/8" Male NPT with 1/4" Reducers
BB3835	10010372	Blubird Rubber Air Hose 3/8" x 35'	3/8"	35'	2 x 3/8" Male NPT with 1/4" Reducers
BB3850	10010374	Blubird Rubber Air Hose 3/8" x 50'	3/8"	50'	2 x 3/8" Male NPT with 1/4" Reducers
BB38100	10010352	Blubird Rubber Air Hose 3/8" x 100'	3/8"	100'	2 x 3/8" Male NPT with 1/4" Reducers
BB1225	10010283	Blubird Rubber Air Hose 1/2" x 25'	1/2"	25'	2 x 1/2" Male NPT + 3/8" Reducer
BB1250	10010290	Blubird Rubber Air Hose 1/2" x 50'	1/2"	50'	2 x 1/2" Male NPT + 3/8" Reducer
BB12100	10010277	Blubird Rubber Air Hose 1/2" x 100'	1/2"	100'	2 x 1/2" Male NPT + 3/8" Reducer
BB3450	10010439	Blubird PRO Rubber Air Hose 3/4" x 50'	3/4"	50'	2 x 3/4" Male NPT
BB34100	10010435	Blubird PRO Rubber Air Hose 3/4" x 100'	3/4"	100'	2 x 3/4" Male NPT

Extension Hoses

Model#	SKU#	Description	I.D	Length	Fitting
BB3810	10010350	Blubird Rubber Air Hose 3/8" x 10'	3/8"	10'	2 x 3/8" Male NPT
BB3815	10010358	Blubird Rubber Air Hose 3/8" x 15'	3/8"	15'	2 x 3/8" Male NPT
BB1210	10010276	Blubird Rubber Air Hose 1/2" x 10'	1/2"	10'	2 x 1/2" Male NPT
BB1215	10010281	Blubird Rubber Air Hose 1/2" x 15'	1/2"	15'	2 x 1/2" Male NPT
BB3410	10012288	Blubird PRO Rubber Air Hose 3/4" x 10'	3/4"	10'	2 x 3/4" Male NPT
BB3415	10010436	Blubird PRO Rubber Air Hose 3/4" x 15'	3/4"	15'	2 x 3/4" Male NPT



40% Lighter than Traditional Rubber Air Hoses | **100% Rubber**

Safest | Strongest | Most Flexible

BluBird Rubber Air Hose Patriot Pro Edition comes in a heavy-duty wrapped finish designed to provide extra abrasion resistance and offers exceptional cold weather flexibility and durability. BluBird hoses are 40% lighter, stronger and more flexible than other rubber hoses. BluBird hoses have superior cold weather flexibility down to -50°F and maintains its integrity up to +190°F making it a year-round hose in most parts of the world.

3
YEAR
WARRANTY



- Solid brass fittings that are superior to aircraft aluminium fittings
- High strength polyester braided reinforcement
- 300 PSI working pressure
- 4:1 Safety factor
- Maintains integrity under extreme weather conditions
- Flexibility from -50°F to +190°F
- Ozone resistant | Abrasion resistant | Kink resistant
- 4-Finger grip bend restrictor for better use & easier control over the hose

Heavy-duty wrapped finish
100% Rubber construction
40% Lighter hose than traditional rubber air hoses



Flexibility in extreme conditions from -50°F to +190°F

300 PSI Working Pressure

1200 PSI Burst Pressure

4:1 Safety Factor

Model#	SKU#	Description	I.D	Length	Fitting
PP3815-1	10011202	Blubird Patriot Pro Rubber Air Hose 3/8" x 15'	3/8"	15'	2 x 1/4" Male NPT
PP3825-1	10011203	Blubird Patriot Pro Rubber Air Hose 3/8" x 25'	3/8"	25'	2 x 3/8" NPT Male with 1/4" Reducers
PP3850-1	10011204	Blubird Patriot Pro Rubber Air Hose 3/8" x 50'	3/8"	50'	2 x 3/8" NPT Male with 1/4" Reducers
PP1215	10011198	Blubird Patriot Pro Rubber Air Hose 1/2" x 15'	1/2"	15'	2 x 1/2" Male NPT
PP1225	10011199	Blubird Patriot Pro Rubber Air Hose 1/2" x 25'	1/2"	25'	2 x 1/2" Male NPT with 3/8" reducer
PP1250	10011200	Blubird Patriot Pro Rubber Air Hose 1/2" x 50'	1/2"	50'	2 x 1/2" Male NPT with 3/8" reducer

- Solid brass fittings that are superior to aircraft aluminium fittings
- High strength polyester woven braided reinforcement
- 300 PSI working pressure
- 4:1 Safety factor
- Maintains integrity under extreme weather conditions

- Flexibility from -50°F to +190°F
- Ozone resistant
- Abrasion resistant
- Kink resistant
- 4-Finger grip bend restrictor for better use & easier control over the hose.



FastFix fittings allow a damaged hose to be repaired in a few minutes

Solid Brass FastFix Fittings are superior to aircraft aluminum fittings

The BluBird FastFix Hose is a combination of the BluBird Hose and FastFix field repairable fittings. The BluBird hose is the lightest, strongest most flexible 100% rubber air hose ever made and the FastFix field repairable fittings make it easy and fast to repair a hose in minutes, restoring the hose to it's original 300 PSI working pressure, 1200 PSI burst rating. The FastFix fittings are 100% brass for strength and durability.

10
YEAR
WARRANTY
ON HOSE

1
YEAR
WARRANTY
ON ACCESSORIES



Field repairable fittings

Hose Features

- Solid brass fittings that are superior to aircraft aluminium fittings
- 40% Lighter hose than standard rubber air hoses
- 100% Rubber construction
- High strength polyester braided reinforcement
- Maintains integrity under extreme weather conditions
- Ozone resistant
- Abrasion resistant
- Kink resistant
- 4-Finger grip bend restrictor for better use & easier control over the hose



Flexibility in extreme conditions from -50°F to +190°F

300 PSI Working Pressure

1200 PSI Burst Pressure

4:1 Safety Factor

Model#	SKU#	Description	I.D	Length	Fitting
BB1450-FX	10010323	Blubird Air Hose 1/4" x 50' with field Repairable Fittings	1/4"	50'	2 x 1/4" Male NPT
BB14100-FX	10010311	Blubird Air Hose 1/4" x 100' with field Repairable Fittings	1/4"	100'	2 x 1/4" Male NPT





How to fix a damaged hose with FastFix?



1 Determine where the hose is damaged



2 Pull the bend restrictor past where the hose is damaged



3 Unscrew the FastFix fitting



4 Slide the lower portion of the FastFix fitting past where the hose is damaged



5 Cut the hose at the end where the remaining part of the FastFix fitting is



6 Remove the barbed swivel fitting from the end of the hose

Cut and remove the damaged part of the hose



Insert barbed swivel into the end of the hose



Slide the lower part of the Fastfix fitting and screw onto the swivel and tighten



Slide the bend restrictor back up to the fitting



Double check that everything is connected properly and tight



Your hose is as good as it was before

FastFix Fittings

Model#	SKU#	Description
FFFX12	10010570	Fast Fix - 1/2" Air Hose Assembly Repair Fitting - w/ 1/2" MNPT Fixed
FFFX14	10010571	Fast Fix - 1/4" Air Hose Assembly Repair Fitting - w/ 1/4" MNPT Fixed
FFFX38	10010572	Fast Fix - 3/8" Air Hose Assembly Repair Fitting - w/ 1/4" MNPT Fixed
FFSP12	10010573	Fast Fix - 1/2" Air Hose Assembly Repair Fitting - w/ 1/2" MNPT Splicer
FFSP14	10010574	Fast Fix - 1/4" Air Hose Assembly Repair Fitting - w/ 1/4" MNPT Splicer
FFSP38	10010575	Fast Fix - 3/8" Air Hose Assembly Repair Fitting - w/ 1/4" MNPT Splicer
FFSW14	10010576	Fast Fix - 1/4" Air Hose Assembly Repair Fitting - w/ 1/4" MNPT Swivel
FFSW38	10010577	Fast Fix - 3/8" Air Hose Assembly Repair Fitting - w/ 1/4" MNPT Swivel



Quick Connects Coupler & Plug

The BluBird Quick-Connects Hose is a BluBird Air Hose that comes with a quick-connect coupler and plug making it easy and quick to change different tools and accessories. The BluBird Air Hose is the lightest, strongest, most flexible 100% rubber air hose ever made and the quick connect coupler and plug are made of solid brass which are superior to aircraft aluminum fittings.

10
YEAR
WARRANTY
ON HOSE

1
YEAR
WARRANTY
ON ACCESSORIES



Solid Brass Quick-Connects Coupler/Plug that are superior to aircraft aluminium fittings

Hose Features

- 40% Lighter hose than standard rubber air hoses
- 100% Rubber construction
- High strength polyester braided reinforcement
- Maintains integrity under extreme weather conditions
- Ozone resistant
- Abrasion resistant
- Kink resistant
- 4-Finger grip bend restrictor for better use & easier control over the hose



Flexibility in extreme conditions from -50°F to +190°F

300 PSI Working Pressure

1200 PSI Burst Pressure

4:1 Safety Factor

Model#	SKU#	Description	I.D	Length	Fitting
BB14100-QC	10010313	BluBird Rubber Air Hose 1/4" x 100' w/ Quick Connect	1/4"	100'	2 x 1/4" Male NPT
BB3850-QC	10010381	BluBird Rubber Air Hose 3/8" x 50' w/ Quick Connect	3/8"	50'	2 x 1/4" Male NPT



Coupler



Plug

Heavy-Duty Industrial Type Quick Connects with 1/4" Female Ends

Solid heavy-duty construction with ball locking mechanism, nitrile seals for optimum performance in extreme temperatures. Industrial/M' style interchange adapts to all industrial/M-style plugs/nipples



A perfect kit to have in your Semi!

Fleet Edition Tire Inflator Kit

The BluBird Tire Inflator Fleet Edition Kit has everything you need to fill up flat or low tires anywhere. The kit has 50' of 3/8" BluBird Air Hose. BluBird being the lightest, strongest, most flexible 100% rubber air hose ever made. The kit also contains a universal heavy-duty aluminium glad hand made by Phillips (Made in the USA) Industries and a dual foot chuck inflator. The kit contains teflon tape and an adapter that allows a tool to be connected. Everything stores neatly in a reusable storage bag.

10
YEAR
WARRANTY
ON HOSE

2
YEAR
WARRANTY
ON ACCESSORIES



Hose Features

- 40% Lighter hose than standard rubber air hoses
- 100% Rubber construction
- Solid brass fittings that are superior to aircraft aluminium fittings
- High strength polyester woven braided reinforcement
- Maintains integrity under extreme weather conditions
- Ozone resistant
- Abrasion resistant
- Kink resistant
- 4-Finger grip bend restrictor for better use & easier control over the hose

Kit Includes

1. Phillips (Made in USA) Heavy-duty aluminium universal glad hand
2. Dual foot chuck inflator
3. Teflon tape
4. Carry bag for easy storage after use



YouTube



Flexibility in extreme conditions from -50°F to +190°F

300 PSI Working Pressure

1200 PSI Burst Pressure

4:1 Safety Factor

Model#	SKU#	Description	I.D	Length	Fitting
BBFLT3850	10010387	Blubird Rubber Air Hose 3/8" x 50' w/ Fleet Edition	3/8"	50'	2 x 1/4" Male NPT

1

Connect dual foot chuck to the hose



2

Connect glad hand to the hose



3

Disconnect air line from the truck



4

Connect air line with the glad hand. **You're ready to fill truck tires anytime, anywhere.**



BluBird®

Air Compressor Kit

The BluBird Air Accessory Kit contains many solid brass industrial style air compressor fittings and hose you will need in one reusable storage bag. The kit is perfect to have in your garage, cabin or truck. The storage bag keeps all the fittings and the hose readily accessible.

10
YEAR
WARRANTY
ON HOSE

1
YEAR
WARRANTY
ON ACCESSORIES



Hose Features

- 40% Lighter hose than standard rubber air hoses
- 100% Rubber construction
- Solid brass fittings that are superior to aircraft aluminium fittings
- High strength polyester braided reinforcement
- Maintains integrity under extreme weather conditions
- Ozone resistant
- Abrasion resistant
- Kink resistant
- 4-Finger grip bend restrictor for better use & easier control over the hose

Kit Includes

BluBird® Air Hose, Safety Blow Gun (1), Tire Gauge(1), Air Chuck (1), Male Plugs Industrial Style 1/4" NPT (3), Female Plugs Industrial Style 1/4" NPT (2), Male Coupler Industrial Style 1/4" NPT (1), Female Coupler Industrial Style 1/4" NPT (1), Teflon Tape (1), Storage Bag (1).



YouTube



Flexibility in extreme conditions from -50°F to +190°F

300 PSI Working Pressure

1200 PSI Burst Pressure

4:1 Safety Factor

Model#	SKU#	Description	I.D	Length	Fitting
BB3825KIT-10	10010368	Blubird Rubber Air Hose 3/8" x 25' w/ 13pc Brass Kit	3/8"	25'	2 x 1/4" Male NPT
BB3850KIT-10	10010385	Blubird Rubber Air Hose 3/8" x 50' w/ 13pc Brass Kit	3/8"	50'	2 x 1/4" Male NPT



BluBird Pro

Jackhammer Hose

Perfect Hose for Construction Sites

BluBird Jackhammer Hoses are 9 lbs lighter than standard jackhammer hoses but are stronger and more flexible. Designed to offer exceptional flexibility even in extreme conditions down to -50°F and up to +190°F these hoses can be used year-round in most parts of the world. These hoses are constructed with abrasion resistant external covers and high strength polyester reinforcement to prevent elongation and add superior strength with a 300 PSI working pressure and a 4:1 safety factor. The heavy-duty wrapped finish prevents the hose from damage and wear in different applications and environments. The hose features stainless steel claw couplings for longer life than cast iron fittings.

2
YEAR
WARRANTY



- 100% Rubber construction
- 9 Lbs lighter hose than standard jack hammer hoses
- Stainless steel claw fittings
- Heavy-duty wrapped finish makes it more resistant
- Maintains integrity under extreme weather conditions
- Ozone resistant
- Kink resistant
- High strength polyester braided reinforcement
- 4-Finger grip bend restrictor for better use & easier control over the hose



**Stainless steel
claw fittings**



Flexibility in extreme conditions from -50°F to +190°F

300 PSI Working Pressure

1200 PSI Burst Pressure

4:1 Safety Factor



Model#	SKU#	Description	I.D	Length	Fitting
BBJH3415	10010436	Blubird Jack Hammer Hose 3/4" x 15'	3/4"	15'	2 x 3/4" Male NPT with 1/2" Reducer
BBJH3450	10010439	Blubird Jack Hammer Hose 3/4" x 50'	3/4"	50'	2 x 3/4" Male NPT with 1/2" Reducer
BBJH34100	10010435	Blubird Jack Hammer Hose 3/4" x 100'	3/4"	100'	2 x 3/4" Male NPT with 1/2" Reducer



A Perfect Shop Hose

RMA Class-A Oil Resistant Air Hose

30% Lighter than Traditional Rubber Air Hoses in same class
100% Rubber

OilShield is the best shop hose in the market today. It is a 100% rubber hose with a nitrile core and nitrile cover giving OilShield a class-A oil resistance rating. The best oil resistance rating possible. OilShield unlike other heavy and stiff rubber air hoses is 30% lighter than traditionally made rubber hoses, more flexible & stronger. It is the perfect shop hose where hoses come in contact with oil, diesel, fuel, gas, cleaning agents and anything else found in shops including welding spatter and grinding sparks.



- RMA class-A oil resistant core tube and cover
- Resists welding spatters and grinding sparks
- Solid brass fittings that are superior to aircraft aluminium fittings
- High strength polyester braided reinforcement
- Maintains integrity under extreme weather conditions
- Ozone resistant
- Abrasion resistant
- Kink resistant
- 4-Finger grip bend restrictor for better use & easier control over the hose



Flexibility in extreme conditions from -30°F to +180°F

300 PSI Working Pressure

1200 PSI Burst Pressure

4:1 Safety Factor

General Purpose Hoses

Model#	SKU#	Description	I.D	Length	Fitting
OS3825	122037	Oilshield Rubber Air Hose 3/8" x 25'	3/8"	25'	2 x 3/8" Male NPT 1/4" Reducers
OS3835	121914	Oilshield Rubber Air Hose 3/8" x 35'	3/8"	35'	2 x 3/8" Male NPT 1/4" Reducers
OS3850	121250	Oilshield Rubber Air Hose 3/8" x 50'	3/8"	50'	2 x 3/8" Male NPT 1/4" Reducers
OS38100	121717	Oilshield Rubber Air Hose 3/8" x 100'	3/8"	100'	2 x 3/8" Male NPT 1/4" Reducers
OS1225	120633	Oilshield Rubber Air Hose 1/2" x 25'	1/2"	25'	2 x 1/2" Male NPT with 3/8" reducer
OS1250	122035	Oilshield Rubber Air Hose 1/2" x 50'	1/2"	50'	2 x 1/2" Male NPT with 3/8" reducer
OS12100	121264	Oilshield Rubber Air Hose 1/2" x 100'	1/2"	100'	2 x 1/2" Male NPT with 3/8" reducer

Extension Hoses

Model#	SKU#	Description	I.D	Length	Fitting
OS3810	122036	Oilshield Rubber Air Hose 3/8" x 10'	3/8"	10'	2 x 3/8" Male NPT
OS3815	121265	Oilshield Rubber Air Hose 3/8" x 15'	3/8"	15'	2 x 3/8" Male NPT

Lightweight / Super Strong

20% Lighter than Traditional
Rubber Air Hoses
100% Rubber

Dino Hide is the evolution of the old-fashioned "Red Rubber" hose. The old-fashioned hoses are heavy and stiff. Dino Hide is 20% lighter than traditional rubber hoses and are also more flexible and stronger. They have an unmatched 5 year warranty and a mid-range price point.

3
YEAR
WARRANTY



- Solid brass fittings that are superior to aircraft aluminium fittings
- 20% Lighter hose than standard rubber air hoses
- 100% Rubber construction
- High strength polyester woven braided reinforcement
- Maintains integrity under extreme weather conditions
- Ozone resistant
- Abrasion resistant
- Kink resistant
- 4-Finger grip bend restrictor for better use & easier control over the hose



Flexibility in extreme conditions from -40°F to +190°F

300 PSI Working Pressure

1200 PSI Burst Pressure

4:1 Safety Factor

General Purpose Hoses

Model#	SKU#	Description	I.D	Length	Fitting
WLE3810	10011691	Dino-Hide 3/8" x 10' Rubber Air Hose	3/8"	10'	2 x 3/8" NPT with 1/4" Reducers
WLE3815	10011692	Dino-Hide 3/8" x 15' Rubber Air Hose	3/8"	15'	2 x 3/8" NPT with 1/4" Reducers
WLE3825	10011693	Dino-Hide 3/8" x 25' Rubber Air Hose	3/8"	25'	2 x 3/8" NPT with 1/4" Reducers
WLE3850	10011694	Dino-Hide 3/8" x 50' Rubber Air Hose	3/8"	50'	2 x 3/8" NPT with 1/4" Reducers
WLE1210	10011687	Dino-Hide 1/2" x 10' Rubber Air Hose	1/2"	10'	2 x 1/2" Male NPT with 3/8" reducer
WLE1215	10011688	Dino-Hide 1/2" x 15' Rubber Air Hose	1/2"	15'	2 x 1/2" Male NPT with 3/8" reducer
WLE1250	10011689	Dino-Hide 1/2" x 50' Rubber Air Hose	1/2"	50'	2 x 1/2" Male NPT with 3/8" reducer



20% Lighter than Traditional Rubber Air Hoses
100% Rubber

Lightweight | Super Strong

Avagard is the evolution of the old-fashioned "Red Rubber" hose. The old-fashioned hoses are heavy and stiff. Avagard is 20% lighter than traditional rubber hoses and are also more flexible and stronger. They have an unmatched 5-year warranty and a mid-range price point.

5
YEAR
WARRANTY



- Solid brass fittings that are superior to aircraft aluminium fittings
- High strength polyester woven braided reinforcement
- Maintains integrity under extreme weather conditions
- Flexibility from -40°F to +190°F
- Ozone resistant
- Abrasion resistant
- Kink resistant
- 4-Finger grip bend restrictor for better use & easier control over the hose



Flexibility in extreme conditions from -40°F to +190°F

300 PSI Working Pressure

1200 PSI Burst Pressure

4:1 Safety Factor

General Purpose Hoses

Model#	SKU#	Description	I.D	Length	Fitting
AVG1425	121025	Avagard 1/4" x 25' Rubber Air Hose	1/4"	25'	2 x 1/4" Male NPT
AVG1450	121026	Avagard 1/4" x 50' Rubber Air Hose	1/4"	50'	2 x 1/4" Male NPT
AVG14100	121027	Avagard 1/4" x 100' Rubber Air Hose	1/4"	100'	2 x 1/4" Male NPT
AVG3825	121029	Avagard 3/8" x 25' Rubber Air Hose	3/8"	25'	2 x 3/8" NPT with 1/4" Reducers
AVG3850	121897	Avagard 3/8" x 50' Rubber Air Hose	3/8"	50'	2 x 3/8" NPT with 1/4" Reducers
AVG38100	121898	Avagard 3/8" x 100' Rubber Air Hose	3/8"	100'	2 x 3/8" NPT with 1/4" Reducers
AVG1225	121024	Avagard 1/2" x 25' Rubber Air Hose	1/2"	25'	2 x 1/2" Male NPT with 3/8" reducer
AVG1250	121334	Avagard 1/2" x 50' Rubber Air Hose	1/2"	50'	2 x 1/2" Male NPT with 3/8" reducer
AVG12100	121718	Avagard 1/2" x 100' Rubber Air Hose	1/2"	100'	2 x 1/2" Male NPT with 3/8" reducer

Extension Hoses

Model#	SKU#	Description	I.D	Length	Fitting
AVG3810	121509	Avagard 3/8" x 10' Extension Rubber Air Hose	3/8"	10'	2 x 3/8" NPT
AVG3815	121511	Avagard 3/8" x 15' Extension Rubber Air Hose	3/8"	15'	2 x 3/8" NPT
AVG1210	121492	Avagard 1/2" x 10' Extension Rubber Air Hose	1/2"	10'	2 x 1/2" Male NPT
AVG1215	121495	Avagard 1/2" x 15' Extension Rubber Air Hose	1/2"	15'	2 x 1/2" Male NPT



Ultra-Light and Durable Hose

40% Lighter
than rubber air hoses

Hybrid Air Hose

The Hybrid Air Hose is an ultra-light and durable hose made from a blend of rubber and PVC polymers. It is 40% lighter than traditional rubber hoses and features solid brass ends. The hose is resistant to oil and chemicals, and its solid brass universal coupler is crush-resistant. With a service life of several years, this hose is designed to withstand rigorous use. It resists kinking and tangling under pressure, providing high flow for various projects.

3
YEAR
WARRANTY



- 3-Year warranty
- Chemical resistance
- Extremely resistant to Ozone & UV
- 4-Finger bend restrictor
- 40% Lighter than rubber hoses
- High-visibility color for safety and avoids tripping
- Solid Brass 1/4" NPT ends
- Flexible in extreme temperatures



300 PSI
Working Pressure

1200 PSI
Burst Pressure

4:1 Safety Factor

Model#	SKU#	Description	I.D	Length	Fitting
HY1425	10012106	Hybrid Air Hose 1/4" x 25'	1/4	25	1/4" NPT
HY1450	10012107	Hybrid Air Hose 1/4" x 50'	1/4	50	1/4" NPT
HY14100	10012108	Hybrid Air Hose 1/4" x 100'	1/4	100	1/4" NPT
HY3825	10012109	Hybrid Air Hose 3/8" x 25'	3/8	25	1/4" NPT
HY3850	10012110	Hybrid Air Hose 3/8" x 50'	3/8	50	1/4" NPT
HY38100	10012111	Hybrid Air Hose 3/8" x 100'	3/8	100	1/4" NPT
HY1225	10012112	Hybrid Air Hose 1/2" x 25'	1/2	25	1/2" NPT
HY1250	10012113	Hybrid Air Hose 1/2" x 50'	1/2	50	1/2" NPT
HY12100	10012114	Hybrid Air Hose 1/2" x 100'	1/2	100	1/2" NPT



The Avagard air accessory kit contains many of the most common compressor fittings and a PVC hose that you will need all in one reusable storage bag. The kit is perfect to have in your garage, cabin or truck or anywhere you might need it. The storage bag keeps all of the fittings and hose readily accessible.

PVC Air Hoses & Air Hose Kits

PVC Air Hose designed for DIY use, with extreme durability & flexibility

2
YEAR
WARRANTY
ON HOSE

1
YEAR
WARRANTY
ON ACCESSORIES



13 pc Air Hose Kit

Kit Includes

Avagard® PVC Air Hose, Safety Blow Gun (1), Tire Gauge(1), Air Chuck (1), Male Plugs Industrial Style 1/4" NPT (3), Female Plugs Industrial Style 1/4" NPT (2), Male Coupler Industrial Style 1/4" NPT (1), Female Coupler Industrial Style 1/4" NPT (1), Teflon Tape (1), Storage Bag (1).

Hose Features

- 2 Year limited warranty
- Solid brass fittings that are superior to aircraft aluminium fittings
- Ozone & UV resistance provides protection from weather
- Flexibility in conditions from -10°F to +130°F
- High strength polyester woven braided reinforcement
- Oil resistant cover
- 300 PSI working pressure
- 4:1 Safety factor
- 4-Finger grip bend restrictor for better use & easier control over the hose



10 pc Air Hose Kit

Kit Includes

Avagard® PVC Air Hose, Safety Blow Gun (1), Tire Gauge(1), Air Chuck (1), Male Plugs 1/4" NPT , (1) Female Plugs Industrial Style 1/4" NPT, Female Coupler Industrial Style 1/4" NPT (1), Teflon Tape (1), Rubber Nozel, Safety Nozzel.



Flexibility In Extreme Conditions From -10°F to +130°F

300 PSI Working Pressure

4:1 Safety Factor

Model#	SKU#	Description	I.D	Length	Fitting
PV3810	10011260	Avagard PVC Air Hose 3/8" x 10'2 PVC Air Hose	3/8"	10'	2 x 1/4" Male NPT
PV3815	10011262	Avagard PVC Air Hose 3/8" x 15' PVC Air Hose	3/8"	15'	2 x 1/4" Male NPT
PV3825	10011263	Avagard PVC Air Hose 3/8" x 25' PVC Air Hose	3/8"	25'	2 x 1/4" Male NPT
PV3850KIT	10011276	Avagard PVC Air Hose 3/8" x 50 13pc PVC Air Hose Kit	3/8"	50'	2 x 1/4" Male NPT
PV38100	10011261	Avagard PVC Air Hose 3/8" x 100' PVC Air Hose	3/8"	100'	2 x 1/4" Male NPT
PV3825KIT	10011268	Avagard PVC Air Hose 3/8" x 25' w/ 10pc PVC Air Hose Kit	3/8"	25'	2 x 1/4" Male NPT
PV3850KIT	10011277	Avagard PVC Air Hose 3/8" x 50' w/ 10pc PVC Air Hose Kit	3/8"	50'	2 x 1/4" Male NPT



Perfect hose for roofers and contractors

Premium Poly Air Hose

Avagard braided polyurethane hoses are great for outdoor and indoor use. Having great cold weather flexibility, being lightweight and non-marking, these hoses outperform nylon hoses. They feature bend restrictors to protect the revolving fittings that are on both ends of the hose.

2
YEAR
WARRANTY



1/4in Brass male NPT revolving end

- Bend restrictor for better use & easier control over the hose
- Non-marking exterior
- Abrasion & kink resistant
- Oil resistant
- Flexibility from -40°F up to +165°F
- Three-layered durable construction



Flexibility in extreme conditions from -40°F to 165°F

300 PSI Working Pressure

900 PSI Burst Pressure

Model#	SKU#	Description	I.D	Length	Fitting
PU1425	10011216	Avagard Poly Air Hose 1/4" x 25'	1/4"	25'	2 x 1/4" Male Revolving NPT
PU1450	10011221	Avagard Poly Air Hose 1/4" x 50'	1/4"	50'	2 x 1/4" Male Revolving NPT
PU14100	10011210	Avagard Poly Air Hose 1/4" x 100'	1/4"	100'	2 x 1/4" Male Revolving NPT





Perfect Hose for
Contractors and Shops

Premium Poly Recoil Air Hose

Avagard braided polyurethane recoil hoses are great for outdoor and indoor use. Having great cold weather flexibility, being light-weight and non-marking, these hoses outperform nylon hoses. They feature bend restrictors to protect the revolving fittings that are on both ends of the hose..



1
YEAR
WARRANTY

Features

- Perfect hose for roofers and contractors
- Retains self coiling properties
- Bend restrictor for better use & easier control over the hose
- 300 PSI working pressure
- 3:1 safety factor
- Non-marking exterior
- Abrasion & kink resistant
- Oil resistant
- Flexibility from -40°F upto +165°F
- Three-layered durable construction

Model#	SKU#	Description	I.D	Length	Fitting
PUBR1415	10011225	Avagard PU Braided Recoil Air Hose 1/4" x 15' Translucent Blue	1/4"	15'	2 x 1/4" Male Revolving NPT
PUBR1425	10011226	Avagard PU Braided Recoil Air Hose 1/4" x 25' Translucent Blue	1/4"	25'	2 x 1/4" Male Revolving NPT

Translucent PU Recoil Air Hoses

Avagard premium polyurethane recoil hose is a perfect choice for anyone wanting a compact hose that recoils back to it's original length. The hose comes with field repairable fittings allowing a damaged hose to be repaired quickly and easily..



1
YEAR
WARRANTY

Features

- Retains self coiling properties
- 4-Finger grip bend restrictor for better use & easier control over the hose
- 150 PSI working pressure
- 3:1 safety factor
- Flexibility from -40°F to +100°F
- Non-marking exterior
- Abrasion & kink resistant
- Oil resistant

Model#	SKU#	Description	I.D	Length	Fitting
PUR3815	10011241	Avagard PU Recoil Premium Air Hose 3/8" x 15' Blue	3/8"	15'	2 x 1/4 Revolving Male NPT

Lorem ipsum

PU Recoil

The Avagard economy polyurethane recoil hose is perfect for a Do-it-Yourselfer who's looking for an economic recoil hose.

1
YEAR
WARRANTY



Features

- Perfect hose for DIYers & work stations
- Retains self coiling properties
- Bend restrictor for better use & easier control over the hose
- 120 PSI working pressure
- 3:1 Safety factor

Snubber Air Hoses

Perfect For Work Areas And Shops



The BluBird Snubber Hose is the perfect accessory for your work area. It helps keep the supply hose on the ground and helps prevent a tripping hazard in work area. The BluBird Snubber Hose is made from the same technology of the BluBird hose. It has all the features of the BluBird hose. Put one of the BluBird Snubber Hoses on each tool and make changing out tools quicker and easier as well as keeping your work area safer.

90
DAYS
WORKMANSHIP
WARRANTY



Features

90 Days workmanship warranty

- Solid brass fittings that are superior to aircraft aluminium fittings
- 360° Ball swivel reduces twisting and kinking of hose
- 100% Rubber construction
- 40% Lighter hose than standard rubber air hoses
- High strength polyester woven braided reinforcement
- 300 PSI working pressure | 4:1 Safety factor
- Maintains integrity under extreme weather conditions
- Flexibility from -50°F to +190°F
- Ozone resistant | Abrasion resistant
- Kink resistant
- 4-Finger grip bend restrictor for better use & easier control over the hose

Model#	SKU#	Description	I.D	Length	Fitting
BBSR3805	10010545	Blubird Snubber Air Hose 3/8" x 5' w/ 360° Ball Swivel	3/8"	5'	1/4" FNPT + 1/4" M-Ball Swivel Fitting
BBSR1205	10010541	Blubird Snubber Air Hose 1/2" x 5' w/ 360° Ball Swivel	1/2"	5'	1/2" FNPT + 1/2" M-Ball Swivel



Perfect Hose For Your Shop

The OilShield Snubber Hose is a perfect accessory for your shop. It helps keep the supply hose on the ground and prevents a tripping hazard in the shop. The OilShield Snubber Hose is made from the same award- winning OilShield hose. It also carries the class-A oil resistance rating. Put one of the OilShield Snubber Hoses on each tool and make changing out tools quicker and easier as well as keeping your shop safer.

Features

90 Day workmanship warranty

- Solid brass fittings that are superior to aircraft aluminium fittings
- 360° Ball swivel reduces twisting and kinking of hose
- RMA class-A oil resistant core tube and cover
- Resists welding spatters and grinding sparks
- 100% Rubber construction
- 30% Lighter hose than standard rubber air hoses in same class
- High strength polyester woven braided reinforcement
- 300 PSI working pressure | 4:1 Safety factor
- Maintains integrity under extreme weather conditions
- Flexibility from -30°F to +190°F
- Ozone resistant | Abrasion resistant
- Kink resistant
- 4-Finger grip bend restrictor for better use & easier control over the hose

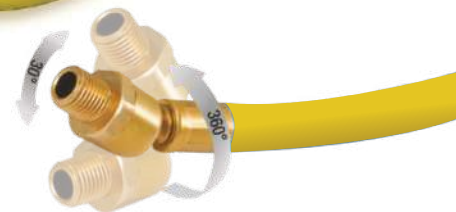

Model#	SKU#	Description	I.D	Length	Fitting
OSSR3805	10011140	Oilshield Snubber Air Hose 3/8" x 5' w/ 360° Ball Swivel	3/8"	5'	1/4" FNPT + 1/4" M-Ball Swivel Fitting

Air Hose Reels

BluBird is the only company in the world that manufactures both hoses and auto-retractable metal reels with hoses. The BluBird heavy duty retractable reels are constructed with either 18 or 20-gauge powder-coated steel that is highly resistant to rubbing, flaking and rust. Both the 18 and 20-gauge reels are equipped with a powerful heavy-duty spring and a class leading 12-point ratchet system that helps lock out the hose at shorter lengths and also enables a smooth auto rewind. The 18-gauge reels also feature a rubber gasket for extended life of the spring. Reels are available in both single and dual arm varieties. The reels carry an unmatched 2-year warranty.

2
YEAR
WARRANTY

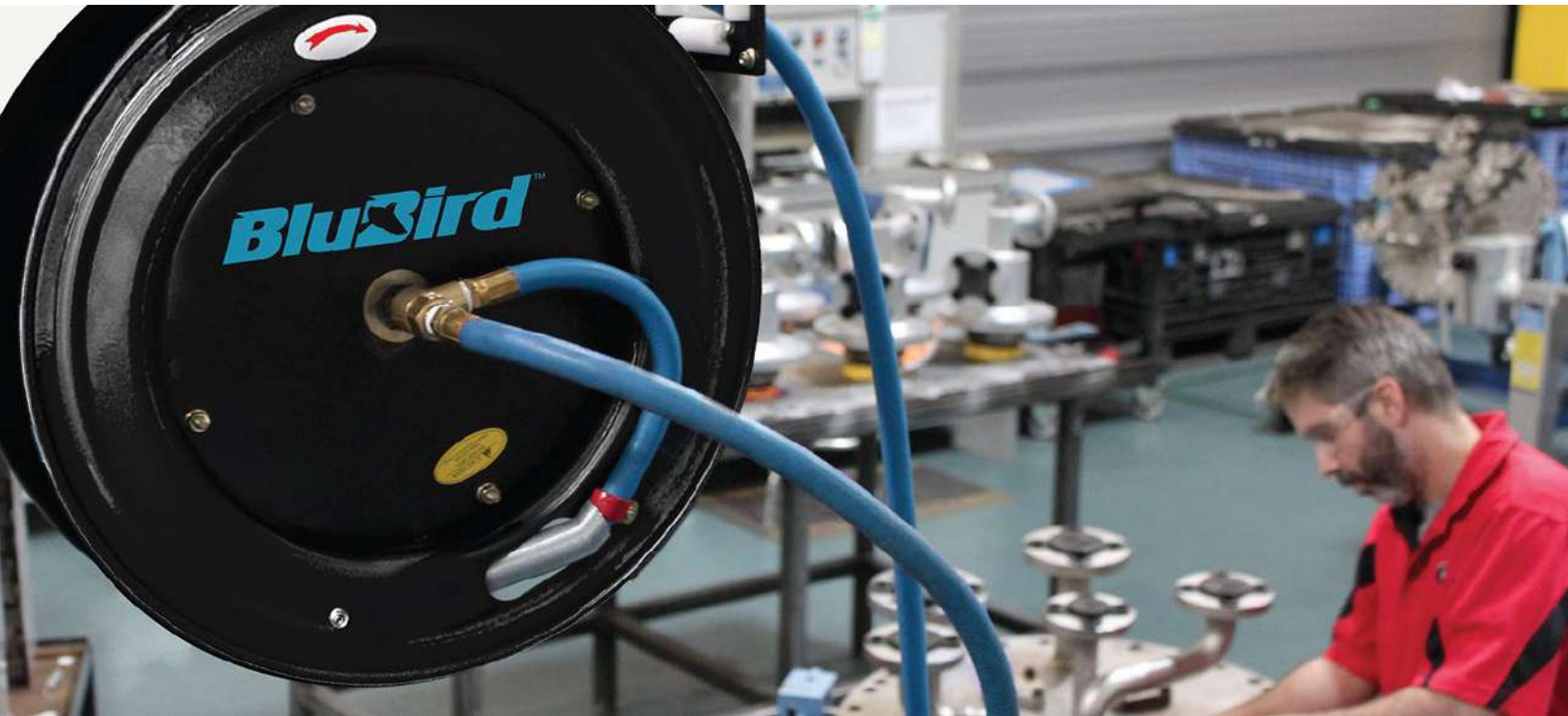

Reel Features

- Unmatched 2 year warranty
- 20/18 Gauge powder-coated steel construction
- 12-Pt ratchet system which helps lock out the hose at shorter lengths
- Specialized internal system reduces the spring vibration, enables quieter operations & extends the life of spring
- Includes 3' Lead-in hose of relevant brand

Mounting Options



Comes with Rubber Gasket



Four rollers reduce hose wear



12-point ratchet gearing system



Dual-Arm Construction for Extreme Stability

Air Hose Reels

BluBird®

Single-Arm Retractable Air Hose Reel (Small)



BluBird®

Single-Arm Retractable Air Hose Reel (Medium)

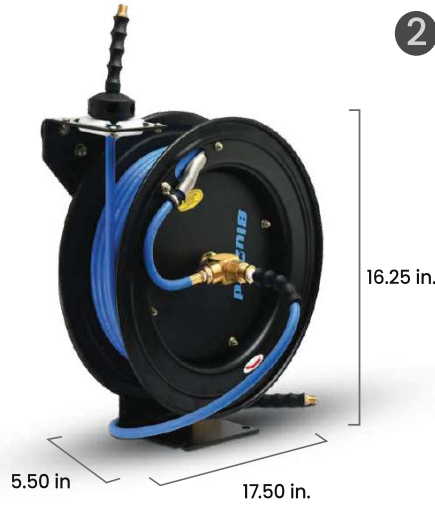

AVAGARD®

by BluBird

Single-Arm Retractable Air Hose Reel (Medium)



Heavy-Duty Air Hose Reels

DINO HIDE

by BluBird

Single-Arm Retractable Air Hose Reel (Medium)



BluBird®

Heavy-Duty Single-Arm Retractable Air Hose Reel (Medium)



OIL SHIELD®

by BluBird

Heavy-Duty Single-Arm Retractable Air Hose Reel (Medium)

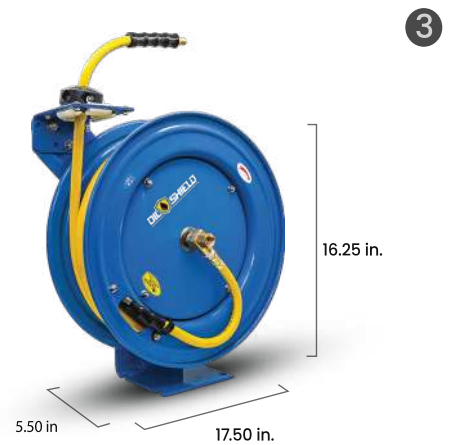

BluBird®

Heavy-Duty Dual-Arm Retractable Air Hose Reel (Medium)



OIL SHIELD®

by BluBird

Heavy-Duty Dual Arm Retractable Air Hose Reel (Medium)



OIL SHIELD®

by BluBird

Heavy-Duty Single-Arm Retractable Air Hose Reel (Large)

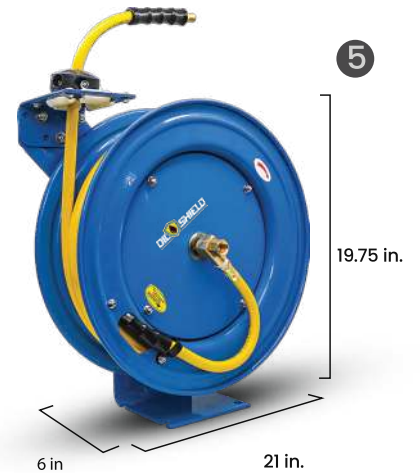

BluBird
Heavy-Duty Single-Arm
Retractable Air Hose Reel (Large)



BluBird
Heavy-Duty Dual Arm
Retractable Air Hose Reel (Large)



OIL SHIELD
by BluBird
Heavy-Duty Dual Arm
Retractable Air Hose Reel (Large)



BluBird
Heavy-Duty Dual Arm
Retractable Air Hose Reel (Extra Large)



OIL SHIELD
by BluBird
Heavy-Duty Dual Arm
Retractable Air Hose Reel (Extra Large)



Auto-retractable hose reel
12Pt. ratchet system locks
hose at shorter distances
Heavy-duty spring vibration
resistant mechanism
Professional grade steel
construction with brass
fittings
Corrosion resistant powder
coat finish
All weather year-round use
Ceiling, wall, floor, rigs &
trailer mountable

Ref#	Model#	SKU#	Description	I.D	Length	Fitting
Single-Arm Air Hose Reels						
1	BBR3825	10010485	Blubird Retractable Rubber Air Hose Reel 3/8" x 25' w/ 3' Lead-In Hose	3/8"	25'	2 x 3/8" Male NPT with reducers
2	BBR3850	10010489	Blubird Retractable Rubber Air Hose Reel 3/8" x 50' w/ 3' Lead-In Hose	3/8"	50'	2 x 3/8" Male NPT with reducers
2	BBR1250	10010468	Blubird Retractable Rubber Air Hose Reel 1/2" x 50' w/ 3' Lead-In Hose	1/2"	50'	2 x 1/2" Male NPT with reducers
2	AVGR1250	10010163	Avagard Retractable Rubber Air Hose Reel 1/2" x 50' w/ 3' Lead-In Hose	1/2"	50'	2 x 1/2" Male NPT with reducers
2	AVGR3850	10010169	Avagard Retractable Rubber Air Hose Reel 3/8" x 50' w/ 3' Lead-In Hose	3/8"	50'	2 x 3/8" Male NPT with reducers
2	WLERHD1250	10011707	Dino-Hide Air Hose Reel Retractable Heavy Duty Steel Construction	1/2"	50'	2 x 1/2" Male NPT with reducers
2	WLERHD3850	10011708	Dino-Hide Air Hose Reel Retractable Heavy Duty Steel Construction	3/8"	50'	2 x 3/8" Male NPT with reducers
Single-Arm Heavy-Duty Air Hose Reels						
3	BBRHD3850	10010515	Blubird Heavy Duty Retractable Rubber Air Hose Reel 3/8" x 50' w/ 3' Lead-In Hose	3/8"	50'	2 x 3/8" Male NPT with reducers
5	BBRHD3875	10010518	Blubird Heavy Duty Retractable Rubber Air Hose Reel 3/8" x 75' w/ 3' Lead-In Hose	3/8"	75'	2 x 3/8" Male NPT with reducers
3	BBRHD1250	10010512	Blubird Heavy Duty Retractable Rubber Air Hose Reel 1/2" x 50' w/ 3' Lead-In Hose	1/2"	50'	2 x 1/2" Male NPT + 3/8" with reducers
3	OSRHD3850	10011136	Oilshield Heavy Duty Retractable Rubber Air Hose Reel 3/8" x 50' w/ 3' Lead-In Hose	3/8"	50'	2 x 3/8" Male NPT with reducers
5	OSRHD3875	10011122	Oilshield Heavy Duty Retractable Rubber Air Hose Reel 3/8" x 75' w/ 3' Lead-In Hose	3/8"	75'	2 x 3/8" Male NPT with reducers
3	OSRHD1250	10011132	Oilshield Heavy Duty Retractable Rubber Air Hose Reel 1/2" x 50' w/ 3' Lead-In Hose	1/2"	50'	2 x 1/2" Male NPT + 3/8" with reducers

Ref#	Model#	SKU#	Description	I.D	Length	Fitting
Dual Arm Heavy Duty Air Hose Reels						
4	BBRDA3850	10010507	Blubird Dual Arm Retractable Rubber Air Hose Reel 3/8" x 50' w/ 3' Lead-In Hose	3/8"	50'	2 x 3/8" Male NPT with reducers
6	BBRDA38100	10010501	Blubird Dual Arm Retractable Rubber Air Hose Reel 3/8" x 100' w/ 3' Lead-In Hose	3/8"	100'	2 x 3/8" Male NPT with reducers
4	BBRDA1250	10010497	Blubird Dual Arm Retractable Rubber Air Hose Reel 1/2" x 50' w/ 3' Lead-In Hose	1/2"	50'	2 x 1/2" Male NPT with reducers
7	BBRDA12100	10010494	Blubird Dual Arm Retractable Rubber Air Hose Reel 1/2" x 100' w/ 3' Lead-In Hose	1/2"	100'	2 x 1/2" Male NPT with reducers
4	OSRDA3850	10011129	Oilshield Dual Arm Retractable Rubber Air Hose Reel 3/8" x 50' w/ 3' Lead-In Hose	3/8"	50'	2 x 3/8" Male NPT with reducers
6	OSRDA38100	10011128	Oilshield Dual Arm Retractable Rubber Air Hose Reel 3/8" x 100' w/ 3' Lead-In Hose	3/8"	100'	2 x 3/8" Male NPT with reducers
4	OSRDA1250	10011126	Oilshield Dual Arm Retractable Rubber Air Hose Reel 1/2" x 50' w/ 3' Lead-In Hose	1/2"	50'	2 x 1/2" Male NPT + 3/8" reducer
7	OSRDA12100	10011124	Oilshield Dual Arm Retractable Rubber Air Hose Reel 1/2" x 100' w/ 3' Lead-In Hose	1/2"	100'	2 x 1/2" Male NPT with reducers



Manual Air Hose Reels

18-GAUGE HEAVY-DUTY CONSTRUCTION

Heavy-duty 18-gauge powder-coated reel is wall and workbench mountable with smooth uncoil and rewind mechanism. The spring-loaded tension brake controls the release of the hose for smooth and safe operation while the spring-loaded locking pin allows to lock the drum in place once the desired hose length is reached. The solid brass swivel ensures leak-free operation.

- 1-Year limited warranty on reel
- Eliminates storage and handling problems
- Holds up to 100' 3/8" air hose
- Solid brass swivel prevents against leaks
- Hand crank with spring loaded axle for easy winding
- Mountable on floor, wall, truck & trailers

Beveled flanges make it easy to roll hose without kinking



Heavy-Duty Brass Swivel



Hand brake prevents the reel from releasing more hose than you need

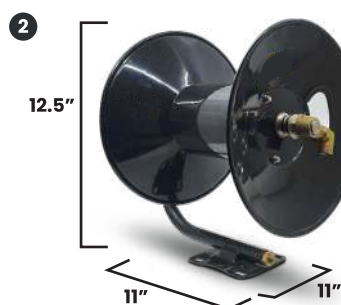

Reel Ref#	Model#	SKU#	Description	I.D	Length	Brass Part
1	BBMR38100	10010428	BluBird Manual Air Hose Reel with 3/8" x 100' Premium Rubber Air Hose	3/8"	100'	3/8"
2	BBMR3850	10010429	BluBird Manual Air Hose Reel with 3/8" x 50' Premium Rubber Air Hose	3/8"	50'	3/8"



Swivel Mount for single-arm hose reels



Swivel Mount for dual-arm hose reels



BluBird mounting bracket allows hose reels to be mounted to the wall and swung sideways allows hose reel to move freely- pivot 140° for extra versatility. Made from 20-gauge heavy duty sturdy all-steel construction with powder coat finish for durability.

Mounting bracket allows hose reels to be mounted to the wall & swung sideways for easy use
 All steel powder-coated construction
 Heavy-duty swivel joints
 Can be mounted on wood, concrete or steel bar



Model#	SKU#	Description	L" X W" X H"	Color
HRS3812	10010797	Hose Reel 140° Swivel Mount for Single Arm Hose Reel	8.5x 5.5x 4.5	Black, Blue
HRS3812DA	10010805	Hose Reel 140° Swivel Mount for Dual Arm Hose Reel	11x 7.5x5.5	Blue



Lead-In Air Hoses

Ideal for connecting supply lines, hose reels, compressors, and other system components.

90 days workmanship warranty



Model#	SKU#	Description	I.D	Length	Fittings
BBLD3803	10010425	BluBird 3/8" Rubber Lead-in Air Hose	3/8"	3'	2 x 1/4" MNPT
BBLD1203	10010422	BluBird 1/2" Rubber Lead-in Air Hose	1/2"	3'	2 x 1/2" MNPT
BB3803-3W	10010346	BluBird 3/8" x 3" Rubber Lead-in Air Hose	3/8"	3'	1/4" MNPT x 3 Way Coupler
WLLED3803	10011697	Dino-Hide 3/8" x 3' Rubber Lead-in Air Hose	3/8"	3'	2 x 1/2" MNPT + 3/8" Reducer
WLLED1203	10011696	Dino-Hide 1/2" x 3' Rubber Lead-in Air Hose	1/2"	3'	2 x 1/2" MNPT Fittings + 3/8" Reducer

AIR BLOW GUNS



et

I/M





BLOW GUNS & ACCESSORIES



BluBird® Modular Blow Guns

Features

- Professional air blow guns with superior control & comfort
- Reduces operator fatigue, variable air flow trigger regulates air volume
- Modular accessories system can be customized for specific jobs
- Ergonomic design with aluminum casted body
- Covered by a 1-year material and workmanship warranty
- All readings at 90 PSI

	Part No.	Description	CFM	dBA	
	BBABG-02-HT1	BluBird HF2 Blow Gun with Hush Tech Nozzle	36	87	
	BBABG-02-MN1	BluBird HF2 Blow Gun with Maxima Nozzle	50	99	
	BBABG-01-HT1	BluBird HF1 Blow Gun with Hush Tech Nozzle	36	87	
	BBABG-01-MN1	BluBird HF1 Blow Gun with Maxima Nozzle	43	99	

BLOW GUN KITS

Modular Blow Gun Kits

BluBird® 10pc Air Blow Gun Kit – HF1

BBABG-01 – Kit 1 Includes :

- BluBird HF1 Blow Gun • Hush Tech Nozzle • Maxima Nozzle
- Rubber Tip • 6 in. Extension (x2) • Tip Adaptor
- 1in. Needle Tip • 2 in. Needle Tip • 3 in. Needle Tip



BluBird® 6pc Air Blow Gun Kit – HF2

BBABG-02 – Kit 1 Includes :

- BluBird HF2 Blow Gun • Hush Tech Nozzle • 3-Way Safety Nozzle
- Maxima Nozzle • Chip Guard • 6 in. Extension



BLOW GUNS & ACCESSORIES



BluBird® Blow Gun Accessories

Features

- Modular accessories help you customize your blow gun do multiple tasks
- BluBird accessories are made with aircraft grade aluminum & resist corrosion
- Easily screws onto BluBird blow guns

BluBird® Nozzles

Part No.	CFM	dBA
BBABG-MN1 BluBird Maxima Safety Nozzle	43	99
BBABG-HT1 BluBird Hush-Tech Safety Nozzle	36	87
BBABG-TT1 BluBird 3 Way Safety Nozzle	53	91



BluBird® Lever Blow Gun

Features

- Lever blow guns perfect for frequent use applications
- Soft rubber tip won't mar delicate surfaces
- Built-in hang hook
- Comfortable thumb lever valve control
- 1/4" NPT Inlet

Part No..	Description	Inlet
-----------	-------------	-------

BBPBG001	1/4" Aluminum Pencil Blow Gun - 1/4 I/M (Industrial)	I/M
----------	---	-----



Part No..	Description	Inlet
-----------	-------------	-------

BBPBG002	1/4" Aluminum Pencil Blow Gun - 1/4 T (Automotive)	T
----------	---	---



BluBird® Pencil Blow Gun

Features

- Lightweight aircraft aluminum
- Twist to adjust or shut off air flow
- Built in handy pocket clip
- 1/4" I/M or T type plug

WATER HOSES/REELS/ ACCESSORIES



40% Lighter than Traditional Rubber Water Hoses

RUBBER WATER HOSES

Blubird Technology has revolutionized the making of a rubber water hose. Traditionally made rubber water hoses are stiff and heavy. Made of 100% rubber, our Ag-Lite hose is the lightest, strongest, most flexible rubber hose ever made. Primarily made for the farm and ag market this hose is perfect to operate with hot water.

10
YEAR
WARRANTY



- Ozone resistant cover provides protection from extreme weather, abrasions & kinks
- Constructed with high strength polyester reinforcement
- 4-Finger grip bend restrictor protects the wear and tear of hose from ends and makes the hose easier to control and use
- Chrome plated brass fittings that are superior to aircraft grade aluminum fittings



YouTube



Water Hose Flow

Hose I.D.	GPM @ 65 PSI	GPM @ 35 PSI
5/8"	11.90	10.30
3/4"	17.10	10.90
1"	24.70	19.80

500 PSI
Burst
Pressure



Flexibility in extreme conditions from -50°F to +190°F



Handles Hot Water up to 212°F

RUBBER WATER HOSE EXTENSION

Model#	SKU#	Description	I.D	Length	Fitting
AL5806	10010014	Ag-Lite Rubber Water Hose Extension 5/8" x 6'	5/8"	6'	2 x 3/4" GHT coupling
AL3406	10010022	Ag-Lite Rubber Water Hose Extension 3/4" x 6'	3/4"	6'	2 x 3/4" GHT coupling
ALONE06	10010034	Ag-Lite Rubber Water Hose Extension 1" x 6'	1"	6'	2 x 3/4" GHT coupling

GENERAL PURPOSE HOSE

Model#	SKU#	Description	I.D	Length	Fitting
AL5810	10010023	Ag-Lite Rubber Water Hose 5/8" x 10'	5/8"	10'	2 x 3/4" GHT coupling
AL5815	10010026	Ag-Lite Rubber Water Hose 5/8" x 15'	5/8"	15'	2 x 3/4" GHT coupling
AL5825	10010028	Ag-Lite Rubber Water Hose 5/8" x 25'	5/8"	25'	2 x 3/4" GHT coupling
AL5850	10010029	Ag-Lite Rubber Water Hose 5/8" x 50'	5/8"	50'	2 x 3/4" GHT coupling
AL5875	10010032	Ag-Lite Rubber Water Hose 5/8" x 75'	5/8"	75'	2 x 3/4" GHT coupling
AL58100	10010024	Ag-Lite Rubber Water Hose 5/8" x 100'	5/8"	100'	2 x 3/4" GHT coupling
AL3410	10010015	Ag-Lite Rubber Water Hose 3/4" x 10'	5/8"	10'	2 x 3/4" GHT coupling
AL3415	10010017	Ag-Lite Rubber Water Hose 3/4" x 15'	3/4"	15'	2 x 3/4" GHT coupling
AL3425	10010018	Ag-Lite Rubber Water Hose 3/4" x 25'	3/4"	25'	2 x 3/4" GHT coupling
AL3450	10010019	Ag-Lite Rubber Water Hose 3/4" x 50'	3/4"	50'	2 x 3/4" GHT coupling
AL3475	10010021	Ag-Lite Rubber Water Hose 3/4" x 75'	3/4"	75'	2 x 3/4" GHT coupling
AL34100	10010016	Ag-Lite Rubber Water Hose 3/4" x 100'	3/4"	100'	2 x 3/4" GHT coupling

WATER TANK FILLERS

Model#	SKU#	Description	I.D	Length	Fitting
ALONE15	10010036	Ag-Lite Rubber Water Hose 1" x 15'	1"	15'	2 x 3/4" GHT coupling
ALONE25	10010037	Ag-Lite Rubber Water Hose 1" x 25'	1"	25'	2 x 3/4" GHT coupling
ALONE50	10010038	Ag-Lite Rubber Water Hose 1" x 50'	1"	50'	2 x 3/4" GHT coupling
ALONE100	10010035	Ag-Lite Rubber Water Hose 1" x 100'	1"	100'	2 x 3/4" GHT coupling



Perfect for Lawn & Garden use

40% Lighter than Traditional Rubber Water Hoses

RUBBER WATER HOSES

Blubird Technology has revolutionized the making of a rubber water hose. Traditionally made rubber water hoses are stiff and heavy. Made from 100% rubber, our BluSeal hose is the lightest, strongest, most flexible rubber hose ever made. Primarily made for the lawn and garden market this hose is perfect to operate with hot water.

10 YEAR WARRANTY



- Ozone resistant cover provides protection from extreme weather, abrasions & kinks
- Constructed with high strength polyester reinforcement
- 4-Finger grip bend restrictor protects the wear and tear of hose from ends and makes the hose easier to control and use
- Chrome plated brass fittings that are superior to aircraft grade aluminum fittings

Water Hose Flow

Hose I.D.	GPM @ 65 PSI	GPM @ 35 PSI
5/8"	11.90	10.30
3/4"	17.10	10.90
1"	24.70	19.80



500 PSI Burst Pressure

Flexibility in extreme conditions from -50°F to +190°F

Handles Hot Water up to 212°F

RUBBER WATER HOSE EXTENSION

Model#	SKU#	Description	I.D	Length	Fitting
BS5806	10010609	Bluseal Rubber Water Hose Extension 5/8" x 6'	5/8"	6'	2 x 3/4" GHT coupling
BS3406	10010597	Bluseal Rubber Water Hose Extension 3/4" x 6'	3/4"	6'	2 x 3/4" GHT coupling
BSONE06	10010634	Bluseal Rubber Water Hose Extension 1" x 6'	1"	6'	2 x 3/4" GHT coupling

GENERAL PURPOSE HOSE

Model#	SKU#	Description	I.D	Length	Fitting
BS5810	10010610	Bluseal Rubber Water Hose 5/8" x 10'	5/8"	10'	2 x 3/4" GHT coupling
BS5815	10010613	Bluseal Rubber Water Hose 5/8" x 15'	5/8"	15'	2 x 3/4" GHT coupling
BS5825	10010614	Bluseal Rubber Water Hose 5/8" x 25'	5/8"	25'	2 x 3/4" GHT coupling
BS5850	10010615	Bluseal Rubber Water Hose 5/8" x 50'	5/8"	50'	2 x 3/4" GHT coupling
BS5875	10010616	Bluseal Rubber Water Hose 5/8" x 75'	5/8"	75'	2 x 3/4" GHT coupling
BS58100	10010612	Bluseal Rubber Water Hose 5/8" x 100'	5/8"	100'	2 x 3/4" GHT coupling
BS58150	10010625	Bluseal Rubber Water Hose 5/8" x 150'	5/8"	150'	2 x 3/4" GHT coupling
BS3410	10010598	Bluseal Rubber Water Hose 3/4" x 10'	3/4"	10'	2 x 3/4" GHT coupling
BS3415	10010603	Bluseal Rubber Water Hose 3/4" x 15'	3/4"	15'	2 x 3/4" GHT coupling
BS3450	10010607	Bluseal Rubber Water Hose 3/4" x 50'	3/4"	50'	2 x 3/4" GHT coupling
BS34100	10010600	Bluseal Rubber Water Hose 3/4" x 100'	3/4"	100'	2 x 3/4" GHT coupling
BS34150	10010619	Bluseal Rubber Water Hose 3/4" x 150'	3/4"	150'	2 x 3/4" GHT coupling

WATER TANK FILLERS

Model#	SKU#	Description	I.D	Length	Fitting
BSONE15	10010636	Bluseal Rubber Water Hose 1" x 15'	1"	15'	2 x 3/4" GHT coupling
BSONE25	10010637	Bluseal Rubber Water Hose 1" x 25'	1"	25'	2 x 3/4" GHT coupling
BSONE50	10010639	Bluseal Rubber Water Hose 1" x 50'	1"	50'	2 x 3/4" GHT coupling
BSONE100	10010635	Bluseal Rubber Water Hose 1" x 100'	1"	100'	2 x 3/4" GHT coupling



Suitable for Professional, Lawn & Garden, Automotive & Industrial use

RUBBER WATER HOSES

The Avagard water hose is 100% rubber. It is 20% lighter than traditionally made rubber water hoses and is also more flexible and stronger. The Avagard water hose handles hot water up to 212°F and is a great mid-price option

5
YEAR
WARRANTY



- Ozone resistant cover provides protection from extreme weather, abrasions & kinks
- Constructed with high strength polyester reinforcement
- 4-Finger grip bend restrictor protects the wear and tear of hose from ends and makes the hose easier to control and use
- Chrome plated brass fittings that are superior to aircraft grade aluminum fittings

Water Hose Flow

Hose I.D.	GPM @ 65 PSI	GPM @ 35 PSI
5/8"	11.90	10.30
3/4"	17.10	10.90
1"	24.70	19.80



20% Lighter than Traditional Rubber Water Hoses



500 PSI Burst Pressure



Flexibility in extreme conditions from -40° to +190°F



Handles Hot Water up to 212°F

RUBBER WATER HOSE EXTENSION

Model#	SKU#	Description	I.D	Length	Fitting
AVGW5806	10010208	Avagard Rubber Water Hose Extension 5/8" x 6'	5/8"	6'	2 x 3/4" GHT coupling
AVGW3406	10010200	Avagard Rubber Water Hose Extension 3/4" x 6'	3/4"	6'	2 x 3/4" GHT coupling

GENERAL PURPOSE HOSE

Model#	SKU#	Description	I.D	Length	Fitting
AVGW5815	10010212	Avagard Rubber Water Hose 5/8" x 15'	5/8"	15'	2 x 3/4" GHT coupling
AVGW5825	10010213	Avagard Rubber Water Hose 5/8" x 25'	5/8"	25'	2 x 3/4" GHT coupling
AVGW5850	10010215	Avagard Rubber Water Hose 5/8" x 50'	5/8"	50'	2 x 3/4" GHT coupling
AVGW5875	10010219	Avagard Rubber Water Hose 5/8" x 75'	5/8"	75'	2 x 3/4" GHT coupling
AVGW58100	10010209	Avagard Rubber Water Hose 5/8" x 100'	5/8"	100'	2 x 3/4" GHT coupling
AVGW3415	10010203	Avagard Rubber Water Hose 3/4" x 15'	5/8"	15'	2 x 3/4" GHT coupling
AVGW3450	10010204	Avagard Rubber Water Hose 3/4" x 50'	5/8"	50'	2 x 3/4" GHT coupling
AVGW34100	10010201	Avagard Rubber Water Hose 3/4" x 100'	5/8"	100'	2 x 3/4" GHT coupling
AVGW1215	10010186	Avagard Rubber Water Hose 1/2" x 15'	1/2"	15'	2 x 3/4" GHT coupling
AVGW1225	10010187	Avagard Rubber Water Hose 1/2" x 25'	1/2"	25'	2 x 3/4" GHT coupling



Ready-Mix Wash Down Hose

20% Lighter than Traditional Wash Down Hoses

The Avagard water hose is 100% rubber. It is 20% lighter than traditionally made rubber water hoses and is also more flexible and stronger. The Avagard water hose handles hot water up to 212°F and is a great mid-price option

1
YEAR
WARRANTY



- Ozone resistant cover provides protection from extreme weather, abrasions & kinks
- Constructed with high-strength polyester woven braided reinforcement
- 4-Finger grip bend restrictor protects the wear and tear of hose from ends and makes the hose easier to control and use
- Chrome-plated brass fittings

Hose I.D.	GPM @ 65 PSI	GPM @ 35 PSI
5/8"	11.90	10.30
3/4"	17.10	10.90
1"	24.70	19.80

500 PSI
Burst
Pressure

Flexibility in extreme
conditions from
-40° F to +190° F

SSSS
Handles Hot Water
up to 212° F

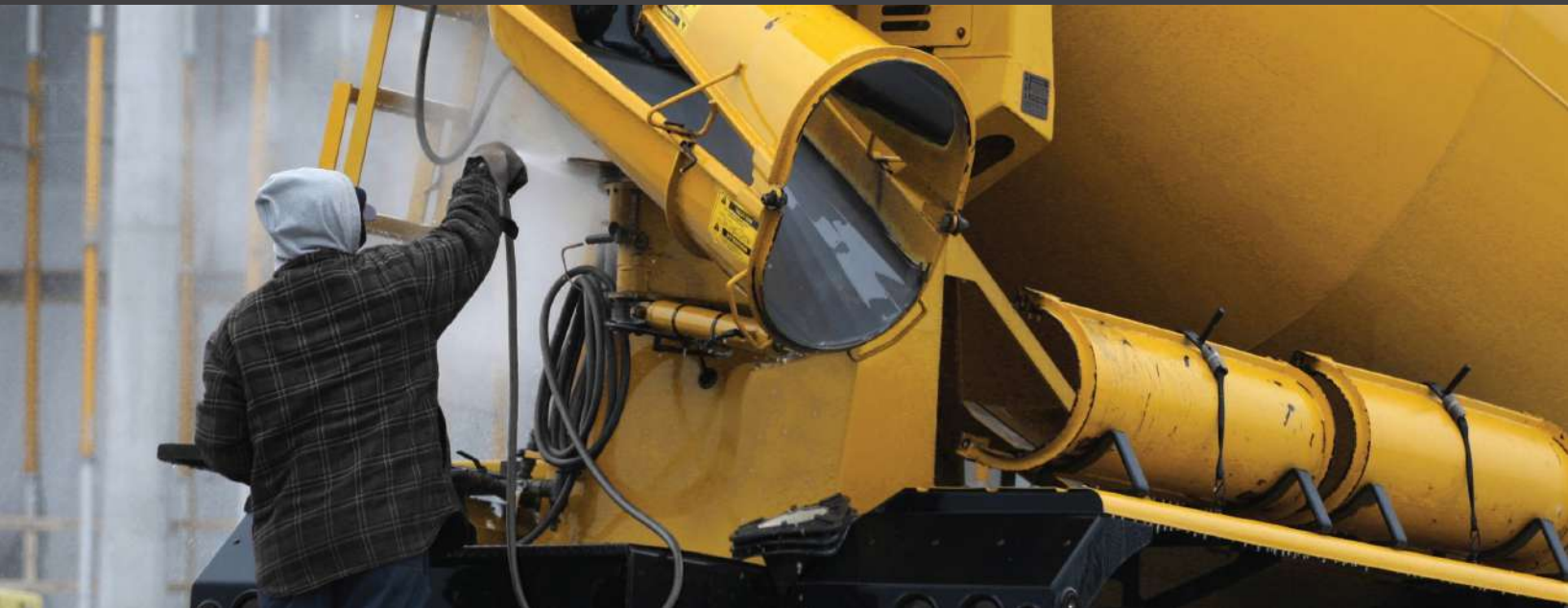

Model#	SKU#	Description	I.D	Length	Fitting
AVGWBK1215	10010186	Avagard Rubber Wash Down Hose 1/2" x 15'	1/2"	15'	2 x 3/4" GHT coupling
AVGWBK1225	10010187	Avagard Rubber Wash Down Hose 1/2" x 25'	1/2"	25'	2 x 3/4" GHT coupling
AVGWOBK5815	10010196	Avagard Rubber Wash Down Hose 5/8" x 15'	5/8"	15'	2 x 3/4" GHT coupling
AVGWOBK5825	10010197	Avagard Rubber Wash Down Hose 5/8" x 15'	5/8"	25'	2 x 3/4" GHT coupling



RUBBER WATER HOSES

LIMITED
LIFETIME
WARRANTY

The Impulse water hose is 100% rubber. It is stronger & more flexible than traditionally made rubber water hoses. These contractor rubber water hoses handle hot & cold water and extreme weather conditions from -40°F to +190°F.



- Ozone resistant cover provides protection from extreme weather, abrasions & kinks
- Constructed with high-strength polyester woven braided reinforcement
- 4-Finger grip bend restrictor protects the wear and tear of hose from ends and makes the hose easier to control and use
- Chrome-plated brass fittings

Water Hose Flow

Hose I.D.	GPM @ 65 PSI	GPM @ 35 PSI
5/8"	11.90	10.30
3/4"	17.10	10.90

500 PSI
Burst
Pressure



Flexibility in extreme
conditions from
-40° F to +190° F



Handles Hot &
Cold Water



Model#	SKU#	Description	I.D	Length	Fitting
RBIMWBK34100	10012404	Impulse Rubber Water Hose 3/4" x 100'	3/4"	100'	3/4" GHT coupling
RBIMWBK3450	10012405	Impulse Rubber Water Hose 3/4" x 50'	3/4"	50'	3/4" GHT coupling
RBIMWBK58100	10012406	Impulse Rubber Water Hose 5/8" x 100'	5/8"	100'	3/4" GHT coupling
RBIMWBK5850	10012407	Impulse Rubber Water Hose 5/8" x 50'	5/8"	50'	3/4" GHT coupling

18-ga. HEAVY-DUTY WATER HOSE REELS

The water hose reels are an ultimate combination of an 18-gauge powder-coated steel body with a heavy-duty steel spring and an industry leading 12-pt ratchet along with a best in class 100% rubber water hose that is the lightest, strongest, most flexible rubber water hose ever made. The reel carries an unmatched 2-year warranty.

Unmatched 2-year warranty

12-Pt. ratchet system that helps lock out the hose at shorter lengths

Can also be mounted on wall, ceiling or floor, trucks and trailers

Specialized internal system reduces the spring vibration, enables quieter operations & extends the life of spring

Includes 6' Lead-in hose

2
YEAR
WARRANTY

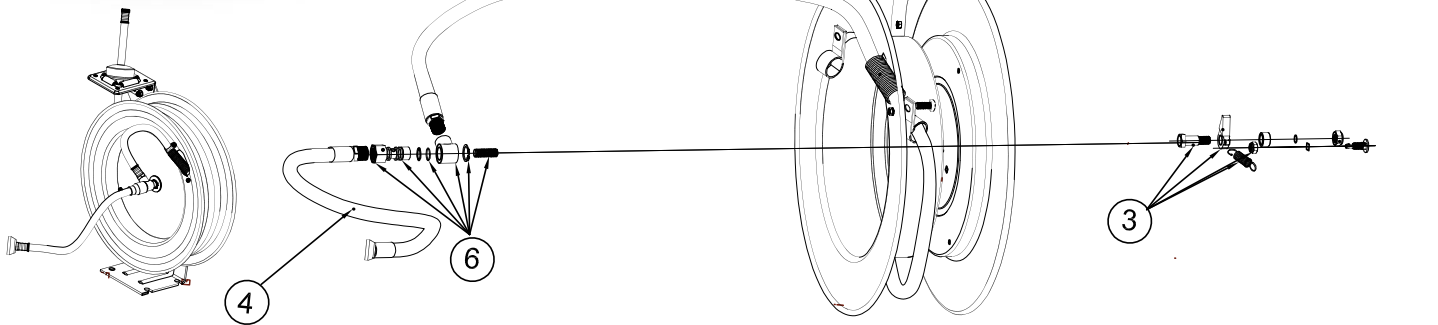

Ref. No.	SKU#	Part Description
1	RSRPL-BLUE	Hose Reel Roller Plate Assembly
2	RSSTP	5/8" Rubber Stopper
3	RSLP	Latch Pawl with Spring
4	FT-BSWR5806-BL	BluSeal 5/8" x 6' Lead-In-Hose
5	FT-BSWR5850-BL	BluSeal 5/8" x 50' Hose
6	RSBR58	5/8" Brass Swivel

Mounting Options



Heavy-Duty Water Hose Reels



Heavy-Duty Single-Arm
Retractable Water Hose Reel (Medium)



AG-LITE Single-Arm
Retractable Water Hose Reel (Medium)



AVAGARD Single-Arm
Retractable Water Hose Reel (Medium)



Stainless Steel Single-Arm
Retractable Water Hose Reel (Medium)



Reel Features

- Unmatched 2-year warranty
- 18-Gauge powder-coated steel construction
- 12-Point ratchet system which helps lock out the hose at shorter lengths
- Specialized internal system reduces the spring vibration, enables quieter operations & extends the life of spring
- Includes 3' Lead-in hose of relevant brand
- Stainless steel reel comes with stainless steel fasteners

Mounting Options

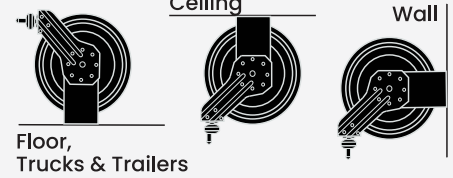

Four rollers reduce hose wear



Comes w Rubber stop



12-point ratchet gearing system





1

Model#	SKU#	Description	I.D	Length	Fitting
BSWR5850	10010655	Bluseal Heavy Duty Retractable Rubber Water Hose Reel 5/8" x 50' w/ 6' Lead-In + Spray Nozzle - Blue Reel	5/8"	50'	2 x 3/4" GHT coupling
BSWR5850-CR	10010656	Bluseal Heavy Duty Retractable Rubber Water Hose Reel 5/8" x 50' w/ 6' Lead-In + Spray Nozzle - Cream Reel	5/8"	50'	2 x 3/4" GHT coupling
BSWR5850-GN	10010657	Bluseal Heavy Duty Retractable Rubber Water Hose Reel 5/8" x 50' w/ 6' Lead-In + Spray Nozzle - Green Reel	5/8"	50'	2 x 3/4" GHT coupling
BSWR5850-GY	10010658	Bluseal Heavy Duty Retractable Rubber Water Hose Reel 5/8" x 50' w/ 6' Lead-In + Spray Nozzle - Grey Reel	5/8"	50'	2 x 3/4" GHT coupling
BSWR3450	10010651	Bluseal Heavy Duty Retractable Rubber Water Hose Reel 3/4" x 50' w/ 6' Lead-In + Spray Nozzle - Blue Reel	3/4"	50'	2 x 3/4" GHT coupling
BSWR3450-CR	10010652	Bluseal Heavy Duty Retractable Rubber Water Hose Reel 3/4" x 50' w/ 6' Lead-In + Spray Nozzle - Cream Reel	3/4"	50'	2 x 3/4" GHT coupling
BSWR3450-GN	10010653	Bluseal Heavy Duty Retractable Rubber Water Hose Reel 3/4" x 50' w/ 6' Lead-In + Spray Nozzle - Green Reel	3/4"	50'	2 x 3/4" GHT coupling
BSWR3450-GY	10010654	Bluseal Heavy Duty Retractable Rubber Water Hose Reel 3/4" x 50' w/ 6' Lead-In + Spray Nozzle - Grey Reel	3/4"	50'	2 x 3/4" GHT coupling



2

Model#	SKU#	Description	I.D	Length	Fitting
ALWR5850	10010039	Ag-Lite Heavy Duty Retractable Rubber Water Hose Reel 5/8" x 50' w/ 6' Lead-In + Spray Nozzle - Cream Reel	5/8"	50'	2 x 3/4" GHT coupling



3

Model#	SKU#	Description	I.D	Length	Fitting
AVGWR5850	10010223	Avagard Heavy Duty Retractable Rubber Water Hose Reel 5/8" x 50' w/ 6' Lead-In + Spray Nozzle - Grey Reel	5/8"	50'	2 x 3/4" GHT coupling



4

Model#	SKU#	Description	I.D	Length	Fitting
BSWRSS5850	10010662	Bluseal Retractable Stainless Steel Rubber Air Hose Reel 5/8" x 50' w/ 6' Lead-In Hose + Spray Nozzle	5/8"	50'	2 x 3/4" GHT coupling
BSWRSS1250	10010661	Bluseal Retractable Stainless Steel Rubber Air Hose Reel 1/2" x 50' w/ 6' Lead-In Hose + Spray Nozzle	1/2"	50'	2 x 3/4" GHT coupling
BSWRSS1250HRS	10010663	Bluseal Retractable Stainless Steel Rubber Air Hose Reel 1/2" x 50' w/ 6' Lead-In Hose + Swivel Mount	1/2"	50'	2 x 3/4" GHT coupling

ACCESSORIES



9 Mode Spray Nozzles

1. Fan 2. Jet 3. Shower 4. Shower+ 5. Center
6. Cone 7. Angle 8. Mist 9. Flat

Class-leading 9 modes of spraying makes it a no-brainer for efficient watering and washing
High-performance allows working up till 20BAR of water pressure
Strong metal+plastic construction with chrome finish
Rubberized ergonomic grip
Locking clip can be switched on to spray without needing to press the trigger



Model#

SKU#

Description

AVGSPR002

10010174

9-Mode Spray Nozzle

8 Mode Spray Nozzles

8 modes of spraying for efficient watering and washing



1. Full 2. Jet 3. Cone 4. Shower
5. Flat 6. Mist 7. Vertical 8. Center

8 Modes of spraying makes it a no-brainer for efficient watering and washing
High-performance allows working up till 20BAR of water pressure
Ergo-Flow control allows you to easily and quickly adjust water outflow
Rubberized Ergonomic grip
Heavy-Duty Construction

Model#

SKU#

Description

AVGSPR003

10010176

8-Mode 2nd Gen Spray Gun

Hose Reel Cart

- Industrial-grade powder-coated steel construction
- Flat-free tires for worry-free use
- Padding handle for comfortable use
- Carriage basket for tools etc
- Includes 2m lead-in hose for water inlet
- Easy assembly



Model#	SKU#	Description
HRC01	10010578	BluSeal Hose Reel Cart (without hose) for 5/8" x 400'

Couplers & Plugs



Faucet End Connector



Product End Connector

Chrome-plated brass construction

Works with all gardening equipment/hoses

Easy to switch watering equipment /water outlets

Smooth quick-release function zero-leakage technology



Faucet End Adaptor



Product End Adaptor

Chrome-plated brass construction

Works with all avagard gardening equipment/ hoses

Easy to switch watering equipment /water outlets

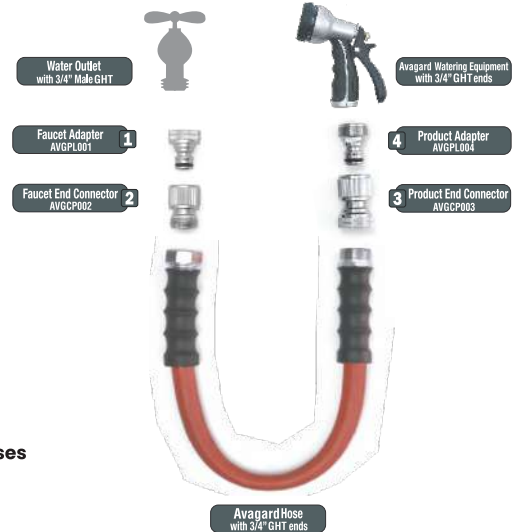

Model#	SKU#	Description
BSPL001	10010640	Quick Connect 3/4" Female GHT Universal Plug
BSCP002	10010630	Quick Connect 3/4" Male GHT Universal Coupler
BSCP003	10010631	Quick Connect 3/4" Female GHT Universal Coupler
BSPL004	10010641	Quick Connect 3/4" Male GHT Universal Plug



Model#	SKU#	Description
AVGPL001	10010140	Quick Connect 3/4" Female GHT Universal Plug
AVGCP002	10010126	Quick Connect 3/4" Male GHT Universal Coupler
AVGCP003	10010128	Quick Connect 3/4" Female GHT Universal Coupler
AVGPL004	10010142	Quick Connect 3/4" Male GHT Universal Plug

Manual Reel



- Can be mounted parallel or perpendicular to the wall
- Powder-coated for durability
- Rated at 100 PSI for use with any municipal water source
- Can be set up in left or right hand-friendly orientation
- Includes a 6ft. rubber connection hose for easy set up, brass fittings and mounting hardware
- 4 bolt mounting pattern is 16in.L x 8 7/8in.W
- 7/16in. bolt holes

Model#	SKU#	Description	Fitting
BSMRW58150	10012159	Bluseal Wall Mounted Manual Hose Reel 5/8"X150'	3/4" Male GHT x 3/4" Female GHT

Hose Hanger



- Keyhole design for easy installation
- Holds up to 150 ft. of water hose
- Heavy-duty steel construction
- Durable powder coat finish for all weather-resistance
- Prevents hose from twisting, kinking, or getting tangled

Swivel Mount



Stainless Steel Swivel Mount



Heavy-Duty Swivel Mount



- Mounting bracket allows hose reels to be mounted to the wall & swung sideways for easy use
- All steel powder-coated construction
- Heavy duty swivel joints
- Can be mounted on wood, concrete or steel bar

SKU#	Numeric#	Description
HRS3812	10010797	140 Degree Swivel Mount for Hose Reel
HRSDA3812	10010807	140 Degree Swivel Mount for Dual Arm Hose Reel

MOTOR MAGAZINE, USA



BluShield™ by RMX 3/8" RUBBER PRESSURE WASHER HOSE - 4100 PSI

PRESSURE WASHER HOSES & REELS

LIGHTEST
STRONGEST
MOST FLEXIBLE
100% RUBBER

**Reinforced with
Aramid**

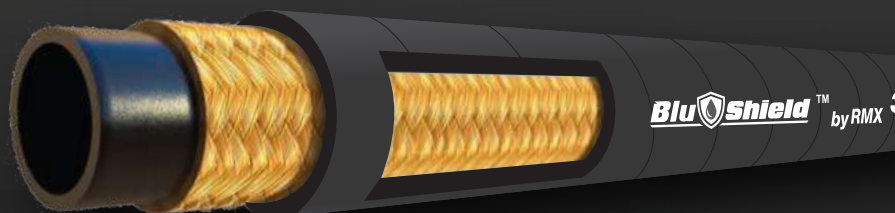



Aramid Braided Pressure Washer Hose

35% Lighter and more flexible than Standard Aramid Braided Rubber Pressure Washer Hose

Pressure Washer Hose

BluShield aramid braided 4100 PSI pressure washer hose is the lightest and most flexible, 100% rubber pressure washer hose ever made. It has a 16,400 PSI burst pressure with safety factor of 4:1. Using aramid fiber for the braiding instead of steel the BluShield pressure washer hose doesn't have all of the negatives associated with wire braided pressure washer hoses. Aramid is 5x's stronger than steel yet it's lighter and more flexible. There are no safety issues with steel shards coming up through the cover or puncturing the core causing the hose to burst. The BluShield pressure washer hose also carries an unmatched 1-year warranty against manufacturing defects.

1
YEAR
WARRANTY



Non-Marking Design

- 4100 PSI Working Pressure | 16400 PSI Burst Pressure
- 1-Year warranty
- 100% Rubber construction
- Aramid braided reinforcement
- Maintains integrity under extreme weather conditions
- Ozone resistant
- Abrasion resistant
- Kink resistant
- Bend restrictor for better use & easier control over the hose



Fitting Available:



Male Swivel



Male Fixed

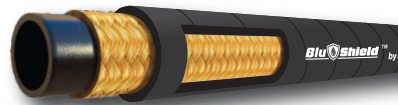

Up to 35% Lighter than Wire Braided Hose



Aramid Braided Reinforcement



More Flexible & Durable vs Wire Braids



Handles Hot Water Up to 250°F



Cold Weather Flexibility Up to -20°F

Model#	SKU#	Description	I.D	Length	Fitting
PW3806	10011303	Blushield Rubber Pressure Washer Hose 3/8" x 6'	3/8"	6'	3/8" M-NPT revolving + 3/8" M-NPT fixed
PW3815	10011313	Blushield Rubber Pressure Washer Hose 3/8" x 15'	3/8"	15'	3/8" M-NPT revolving + 3/8" M-NPT fixed
PW3835	10011326	Blushield Rubber Pressure Washer Hose 3/8" x 35'	3/8"	35'	3/8" M-NPT revolving + 3/8" M-NPT fixed
PW3850	10011333	Blushield Rubber Pressure Washer Hose 3/8" x 50'	3/8"	50'	3/8" M-NPT revolving + 3/8" M-NPT fixed
PW3850-CP	10011334	Blushield Rubber Pressure Washer Hose 3/8" x 50' w/ coupler plug	3/8"	50'	3/8" M-NPT revolving + 3/8" M-NPT fixed+ Coupler Plug
PW3875	10011344	Blushield Rubber Pressure Washer Hose 3/8" x 75'	3/8"	75'	3/8" M-NPT revolving + 3/8" M-NPT fixed
PW38100	10011305	Blushield Rubber Pressure Washer Hose 3/8" x 100'	3/8"	100'	3/8" M-NPT revolving + 3/8" M-NPT fixed
PW38100-CP	10011306	Blushield Rubber Pressure Washer Hose 3/8" x 100' w/ coupler plug	3/8"	100'	3/8" M-NPT revolving + 3/8" M-NPT fixed+ Coupler Plug
PW38200	10011317	Blushield Rubber Pressure Washer Hose 3/8" x 200'	3/8"	200'	3/8" M-NPT revolving + 3/8" M-NPT fixed
PW3835-NM	10011329	Blushield Rubber Pressure Washer Non-Marking Hose 3/8" x 35'	3/8"	35'	3/8" M-NPT revolving + 3/8" M-NPT fixed
PW3850-NM	10011336	Blushield Rubber Pressure Washer Non-Marking Hose 3/8" x 50'	3/8"	50'	3/8" M-NPT revolving + 3/8" M-NPT fixed
PW3850-CP-NM	10011335	Blushield Rubber Pressure Washer Grey non Marking Hose 3/8" x 50' w/ coupler plug	3/8"	50'	3/8" M-NPT revolving + 3/8" M-NPT fixed
PW3875-NM	10011348	Blushield Rubber Pressure Washer Non-Marking Hose 3/8" x 75'	3/8"	75'	3/8" M-NPT revolving + 3/8" M-NPT fixed
PW38100-NM	10011308	Blushield Rubber Pressure Washer Non-Marking Hose 3/8" x 100'	3/8"	100'	3/8" M-NPT revolving + 3/8" M-NPT fixed
PW38100-CP-NM	10011307	Blushield Rubber Pressure Washer Grey Non-Marking Hose 3/8" x 100' w/ coupler plug	3/8"	100'	3/8" M-NPT revolving + 3/8" M-NPT fixed+ Coupler Plug
PW38200-NM	10011320	Blushield Rubber Pressure Washer Non-Marking Hose 3/8" x 200'	3/8"	200'	3/8" M-NPT revolving + 3/8" M-NPT fixed



Aramid Braided Pressure Washer Hose



The Tough Tek aramid braided 4100 PSI pressure washer hose is the lightest and most flexible, 100% rubber pressure washer hose ever. Pressure washer hose doesn't have all of the negatives associated with steel yet it's lighter and more flexible. It is also 4X more abrasion resistant. There are no safety issues with steel shards coming up. The BluShield pressure washer hose also carries an unmatched 1-year warranty against manufacturing defects.

1
YEAR
WARRANTY



35% Lighter and more flexible than wire braided pressure washer hoses

- **4100 PSI Working Pressure | 16400 PSI Burst Pressure**
- 100% Rubber construction
- Aramid woven braided reinforcement
- Maintains integrity under extreme weather conditions
- Ozone resistant
- 4x Abrasion resistant
- Kink resistant
- Bend restrictor for better use & easier control over the hose.

Fitting Available:



Male Swivel



Male Fixed



Up to 35% Lighter than Wire Braided Hose



Aramid Braided Reinforcement



More Flexible & Durable vs Wire Braids



Handles Hot Water Up to 250°F



Cold Weather Flexibility Up to -20°F



Model#	SKU#	Description	I.D	Length	Fitting
PWSF3850	10012742	BluShield Rubber Pressure Washing Hose 3/8" X 50'-Black	3/8"	50'	3/8" M-NPT revolving + 3/8" M-NPT fixed
PWSF38100	10012743	BluShield Rubber Pressure Washing Hose 3/8" X 100'-Black	3/8"	100'	3/8" M-NPT revolving + 3/8" M-NPT fixed
PWSF38200	10012744	BluShield Rubber Pressure Washing Hose 3/8" X 200'-Black	3/8"	200'	3/8" M-NPT revolving + 3/8" M-NPT fixed
PWSF3850-NM	10012747	BluShield Rubber Pressure Washing Hose 3/8" X 50'-Grey	3/8"	50'	3/8" M-NPT revolving + 3/8" M-NPT fixed
PWSF38100-NM	10012748	BluShield Rubber Pressure Washing Hose 3/8" X 100'-Grey	3/8"	100'	3/8" M-NPT revolving + 3/8" M-NPT fixed
PWSF38200-NM	10012749	BluShield Rubber Pressure Washing Hose 3/8" X 200'-Grey	3/8"	200'	3/8" M-NPT revolving + 3/8" M-NPT fixed



Polyester Braided Pressure Washer Hoses

Super Light and flexible polyester braided pressure washer hose

Pressure Washer Hose

BluShield Polyester braided rubber pressure washer hoses are super light and flexible which helps with the coiling and ease of handling of the hose. These lightweight hoses are equipped with bend restrictor which reduces the bending stress near the couplings and increases the working efficiency by adding better control. These hoses have a 3000 PSI working pressure and a 12000 PSI burst pressure with safety factor of (4:1).

1
YEAR
WARRANTY



With M22 Fittings
Non-Marking
Design



• 3000 PSI Working Pressure | 12000 PSI Burst Pressure

- 1-Year warranty
- 100% Rubber construction
- Polyester woven braided reinforcement
- Maintains integrity under extreme weather conditions

- Abrasion resistant
- Kink resistant
- 4-Finger grip bend restrictor for better use & easier control over the hose



Polyester Braided Reinforcement



Handles Hot Water Up to 250°F



Cold Weather Flexibility Up to -20°F



Model#	SKU#	Description	I.D	Length	Fitting
10011297	PWP1425-CP	Blushield Rubber Pressure Washer Hose 1/4" x 25' w/ coupler plug	1/4"	25'	1/4" M-NPT revolving + 1/4" M-NPT fixed
10011301	PWP1450-CP	Blushield Rubber Pressure Washer Hose 1/4" x 50' w/ coupler plug	1/4"	50'	1/4" M-NPT revolving + 1/4" M-NPT fixed
10011296	PWP1425-2-NM	Blushield Pressure Washer Hose 1/4" x 25' - Non-Marking Grey with M22	1/4"	25'	1/4" M-NPT revolving + 1/4" M-NPT fixed
10011300	PWP1450-2-NM	Blushield Pressure Washer Hose 1/4" x 50' - Non-Marking Grey with M22	1/4"	50'	1/4" M-NPT revolving + 1/4" M-NPT fixed
10011292	PWP14100-2-NM	Blushield Pressure Washer Hose 1/4" x 100' - Non-Marking Grey with M22	1/4"	100'	1/4" M-NPT revolving + 1/4" M-NPT fixed

Pressure Washer Hose

BluShield single wire braided rubber pressure washer hoses are super light and flexible which helps with the coiling and ease of handling of the hose. These lightweight hoses are equipped with bend restrictor which reduces the bending stress near the couplings and increases the working efficiency by adding better control. These hoses have a 4000 PSI working pressure and a 16000 PSI burst pressure with safety factor.

Non-Marking Design

- 4000 PSI Working Pressure | 16000 PSI Burst Pressure
- Wire braided reinforced rubber hose resist kinks and abrasion
- Kink and weather resistance will ensure a longer life
- For hot and cold water pressure washers
- 100% Rubber construction
- Ozone resistant
- Abrasion resistant
- Kink resistant
- Bend restrictor for better use & easier control over the hose



Fittings :



12000 PSI Burst Pressure



Model#	SKU#	Description	I.D	Length	Fitting
PWSW3825	10012760	BluShield Single Wire Pressure Washer Hose 3/8" x 25'	3/8"	25'	3/8" M-NPT revolving + 3/8" M-NPT fixed
PWSW3835	10012761	BluShield Single Wire Pressure Washer Hose 3/8" x 35'	3/8"	35'	3/8" M-NPT revolving + 3/8" M-NPT fixed
PWSW3850	10012627	BluShield Single Wire Pressure Washer Hose 3/8" x 50'	3/8"	50'	3/8" M-NPT revolving + 3/8" M-NPT fixed
PWSW38100	10012625	BluShield Single Wire Pressure Washer Hose 3/8" x 100'	3/8"	100'	3/8" M-NPT revolving + 3/8" M-NPT fixed
PWSW38200	10012626	BluShield Single Wire Pressure Washer Hose 3/8" x 200'	3/8"	200'	3/8" M-NPT revolving + 3/8" M-NPT fixed

Pressure Washer Hose Reels

The BluShield heavy-duty retractable metal reels are constructed using 18-gauge powder-coated steel that is highly resistant to rubbing, flaking, and rust. The reel features a heavy-duty steel spring and an industry leading 12-point ratchet which helps lock out the hose at shorter lengths. Also, the reel features a rubber gasket that helps extend the life of the spring. The reels have an unmatched 1-year warranty.

1
YEAR
WARRANTY



Unmatched 1-year warranty

12Pt. ratchet system which helps lock out the hose at shorter lengths

Can also be mounted on wall, ceiling or floor, trucks and trailers

Specialized internal system reduces the spring vibration, enables quieter operations & extends the life of spring

Includes 6' Lead-in hose

Mounting Options

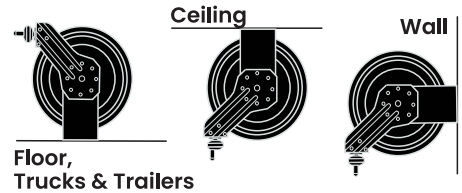

Retractable Pressure Washer Hose Reels

Heavy-Duty Single-Arm Retractable Pressure Washer Hose Reel (Medium)

1



Heavy-Duty Dual-Arm Retractable Pressure Washer Hose Reel (Medium)

2



Four rollers reduce hose wear

Heavy-Duty Dual-Arm Retractable Pressure Washer Hose Reel (Large)

3



Heavy-Duty Dual-Arm Retractable Pressure Washer Hose Reel (Extra Large)

4



12-point ratchet gearing system

Stainless Steel Dual-Arm Retractable Pressure Washer Hose Reel (Large)

5

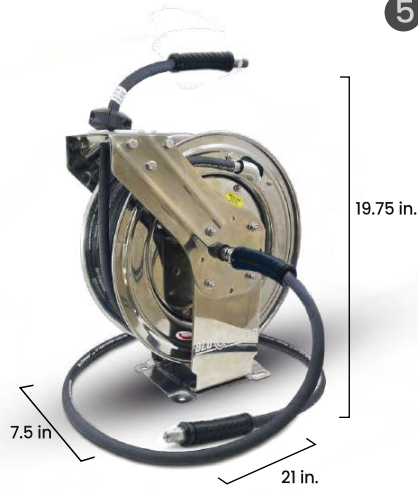

Comes with a rubber stopper



2 Metal arms for extreme stability

Serial#	Model#	SKU#	Description	I.D	Length	Fitting
1	PWR1450-NM	10011369	Blushield Pressure Washer Hose Non-Marking Reel Single-Arm 1/4" x 50' with M22	1/4"	50'	1/4" M-NPT revolving + 1/4" M-NPT fixed M22 Fittings
2	PWR3850	10011388	Blushield Dual-Arm Retractable Rubber Pressure Washer Hose Reel 3/8" x 50' w/ 6' Lead-In Hose	3/8"	50'	3/8" M-NPT revolving + 3/8" M-NPT fixed
2	PWR3850-CP	10011390	Blushield Pressure Washer Hose Reel 3/8" x 50' with Coupler + Plug	3/8"	50'	3/8" M-NPT revolving + 3/8" M-NPT fixed+ Coupler Plug
3	PWR3875	10011391	Blushield Dual-Arm Retractable Rubber Pressure Washer Hose Reel 3/8" x 75' w/ 6' Lead-In Hose	3/8"	75'	3/8" M-NPT revolving + 3/8" M-NPT fixed
4	PWR38100	10011386	Blushield Dual-Arm Retractable Rubber Pressure Washer Hose Reel 3/8" x 100' w/ 6' Lead-In Hose	3/8"	100'	3/8" M-NPT revolving + 3/8" M-NPT fixed
4	PWR38100-CP	10011370	Blushield Pressure Washer Hose Reel 3/8" x 100' with Coupler + Plug	3/8"	100'	3/8" M-NPT revolving + 3/8" M-NPT fixed+ Coupler Plug
2	PWR3850-NM	10011380	Blushield Dual-Arm Retractable Rubber Pressure Washer Non-Marking Hose Reel 3/8" x 50' w/ 6' Lead-In Hose	3/8"	50'	3/8" M-NPT revolving + 3/8" M-NPT fixed+ Coupler Plug
2	PWR3850-CP-NM	10011389	Blushield Pressure Washer Grey Non-Marking Hose Reel 3/8" x 50' with Coupler + Plug	3/8"	50'	3/8" M-NPT revolving + 3/8" M-NPT fixed+ Coupler Plug
3	PWR3875-NM	10011383	Blushield Dual-Arm Retractable Rubber Pressure Washer Non-Marking Hose Reel 3/8" x 75' w/ 6' Lead-In Hose	3/8"	75'	3/8" M-NPT revolving + 3/8" M-NPT fixed
3	PWR14100-2	10012290	Blushield Pressure Washer Hose Reel 1/4" x 100' with M22	1/4"	100'	1/4" M-NPT revolving + 1/4" M-NPT fixed + M22 Fittings
4	PWR38100-NM	10011371	Blushield Dual-Arm Retractable Rubber Pressure Washer Non-Marking Hose Reel 3/8" x 100' w/ 6' Lead-In Hose	3/8"	100'	3/8" M-NPT revolving + 3/8" M-NPT fixed
4	PWR38100-CP-NM	10011387	Blushield Pressure Washer Grey non Marking Hose Reel 3/8" x 100' with Coupler + Plug	3/8"	100'	3/8" M-NPT revolving + 3/8" M-NPT fixed + Coupler Plug
5	PWRSS3850	10011392	Blushield Retractable Stainless Steel Rubber Pressure Washer Hose Reel 3/8" x 50' w/ 6' Lead-In Hose Dual arm	3/8"	50'	3/8" M-NPT revolving + 3/8" M-NPT fixed
5	PWRSS38100	10012285	Blushield Pressure Washer Stainless Steel Hose Reel 3/8" x 100'	3/8"	100'	3/8" M-NPT +3/8" M-NPT
5	PWRSS3875-NM	10012286	Blushield Pressure Washer Non-Marking Stainless Steel Hose Reel 3/8" x 75'	3/8"	75'	3/8" M-NPT +3/8" M-NPT
5	PWRSS38100-NM	10012287	Blushield Pressure Washer Non-Marking Stainless Steel Hose Reel 3/8" x 100'	3/8"	100'	3/8" M-NPT Reel + 3/8" M-NPT
5	PWRSS3875	10012295	Blushield Pressure Washer Stainless Steel Hose Reel 3/8" x 75'	3/8"	75'	3/8" M-NPT+3/8" M-NPT



Pressure Washer Manual Hose Reel

BluShield heavy-duty 18-gauge powder-coated reel is wall and workbench mountable with smooth uncoil and rewind mechanism. The spring loaded tension brake controls the release of the hose for smooth and safe operation while the spring loaded locking pin allows to lock the drum in place once the desired hose length is reached. The solid brass swivel ensures leak-free operation.

1
YEAR
WARRANTY



- 1-year limited warranty on reel.
- Reel holds 200 feet of pressure washing hose (hose not included).
- Solid brass swivel prevent leaks.
- Hand crank with spring loaded axle for easy winding.

Model#	SKU#	Description	Fitting
PWMR50	10012082	Pressure Washer Manual Hose Reel 50' w/o hose	1/4" Mnpt Inlet x 3/8" FNpt Outlet
PWMR100	10012244	Pressure Washer Manual Hose Reel 100' w/o hose	1/4" Mnpt Inlet x 3/8" FNpt Outlet
PWMR150	10012084	Pressure Washer Manual Hose Reel 150' w/o hose	1/4" Mnpt Inlet x 3/8" FNpt Outlet
PWMR200	10012085	Pressure Washer Manual Hose Reel 200' w/o hose	1/4" Mntpt Inlet x 3/8" FNpt Outlet

**A-Frame Pressure Washer
Hose Reel**



- Friction brake
- Direct hand-crank rewind with locking pin
- Solid steel construction
- Durable powder-coated finish
- Full flow swivel stainless swivel

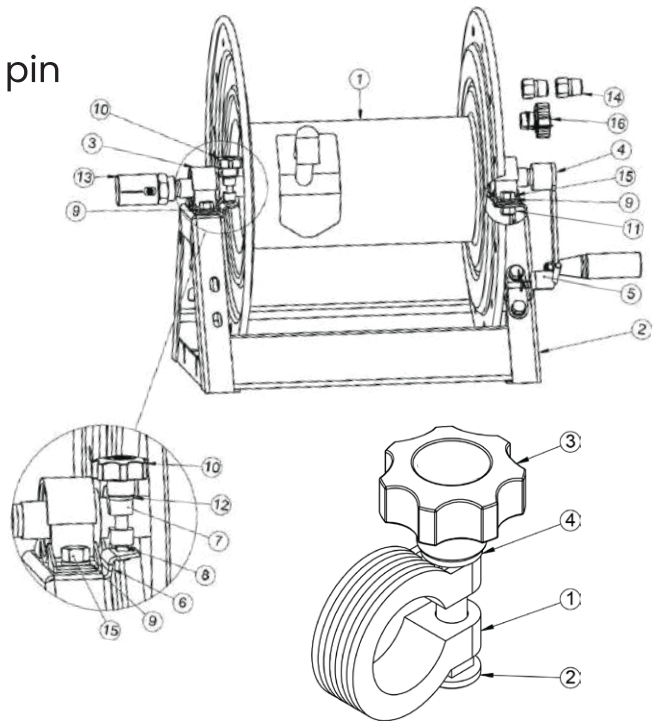
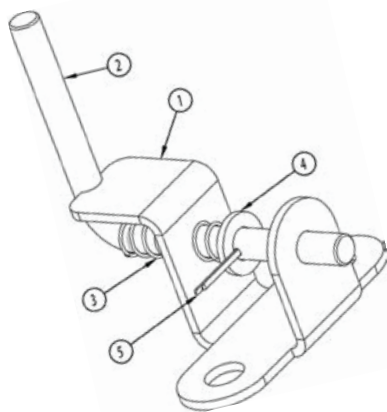

Model#	SKU#	Description
MRAF150	10012658	Pressure Washer Manual A- Frame Hose Reel 150 ft
MRAF300	10012659	Pressure Washer Manual A- Frame Hose Reel 300 ft
MRAF450	10012660	Pressure Washer Manual A- Frame Hose Reel 450 ft



Pressure Washer Jumper Hose

BluShield Pressure Washer Jumper Hose is used for connecting pressure washer to the hose reel. These whip hoses are braided with aramid fibers, commonly known as Kevlar which makes them 35% lighter than other pressure washing hose while making it true heavy-duty. Aramid fibers are well known for their durability and extraordinary tensile strength and are up to 10 times stronger than steel fibers of equal diameter. Included 3/8" NPT ends fit most pressure washer reels.

1
YEAR
WARRANTY



- Jumper/ Whip hose has 3/8" NPT fit most pressure washer hose reel
- Aramid braided hose is lighter with extraordinary tensile strength
- Connect pressure washer with hose reel when they are placed at a shorter distance to each other
- 4100 PSI working pressure | 16400 PSI burst pressure
- Included 2 x 3/8" MNPT fixed

 Up to 35% Lighter than Wire Braided Hose

 Aramid Braided Reinforcement

 More Flexible & Durable vs Wire Braids

 Handles Hot Water Up to 250°F

 Cold Weather Flexibility Up to -20°F

Model#	SKU#	Description	I.D	Length	Fitting
PW3801	10012293	Blushield Presssure Washer Jumper Hose 3/8" x 2'	3/8"	1'	2 x 3/8" MNPT Fixed
PW3802	10012213	Blushield Presssure Washer Hose 3/8" x 4'	3/8"	2'	2 x 3/8" MNPT Fixed
PW3803	10012294	Blushield Presssure Washer Jumper Hose 3/8" x 1'	3/8"	3'	2 x 3/8" MNPT Fixed
PW3804	10012214	Blushield Presssure Washer Jumper Hose 3/8" x 3'	3/8"	4'	2 x 3/8" MNPT Fixed



Pressure Washer Inlet Hose

Cavitation of the water pump engine is the formation & accumulation of bubbles in the pumping chamber on your high pressure pump. When these bubbles are put under pressure, they collapse or burst, creating implosions inside the water hose and equipment, affecting the surrounding parts. The best way to combat cavitation is to have healthy water flow and maintain the seals in your pump. BluBird designs our products to maximize water flow.

1
YEAR
WARRANTY



- 3/4" GHT chrome plated brass fittings
- 500 PSI minimum burst pressure
- 3:1 Safety factor
- Maintains integrity under extreme weather conditions
- Abrasion resistant
- Kink resistant

Water Hose Flow

Hose I.D.	GPM @ 65 PSI	GPM @ 35 PSI
3/4"	17.10	10.90

500 PSI Burst Pressure

3:1 Safety Factor

 Flexibility in Extreme Conditions From -50°F to +190°F

 Handles Hot Water Up to 212°F

1 Year Limited Warranty

Model#	SKU#	Description	I.D	Length	Fitting
BS3415-IH	10010601	BluShield Pressure Washer Inlet Hose Hose size 3/4" x 15'	3/4"	15'	2 x 3/4" GHT coupling
BS3425-IH	10010604	BluShield Pressure Washer Inlet Hose Hose size 3/4" x 25'	3/4"	25'	2 x 3/4" GHT coupling

HP Hose QC Kit



Features:

- Provides secure and quick fittings
- For use with pressure washers up to 4,000 PSI
- Gives you quick-connect fittings to create easy pump-to-hose and hose-to-gun connections
- Compatible with most M22 and quick-connect fittings on pressure washers
- Genuine OEM replacement part

Model#	SKU#	Description
PWA001	10012304	Blushield High Pressure Hose Quick-Connect Kit

BluShield Turbo Nozzle

Features:

- Creates a powerful jet of water
- For use with pressure washers up to 3,000 PSI
- Ideal for cleaning brick, concrete and vinyl
- Turbo nozzle cleans up to 40% faster than standard nozzles
- Connect to quick-connect Wands or fit onto most brands of pressure washers for an intense clean



Model#	SKU#	Description
PWA002	10012305	Blushield Nozzle, 4.0 in.

4000 PSI Quick-Connect Spray Tips



Features:

- Replace old, lost, or worn pressure washer spray tips
- Kit includes four high-pressure spray patterns, including 0°, 15°, 25°, 40°, and one cleaning solution spray tip
- Cleans a variety of surfaces from garage floors to windows
- Pairs with gas pressure washers and quick-connect wands

Model#	SKU#	Description
PWA003	10012306	Blushield 4000 PSI Quick-Connect Spray Tips, 3.5 in.

6-in-1 Nozzle

Features:

- Combines (5) different spray patterns into one convenient head
- Eliminate the loss of multiple nozzles by combining all functions into one
- Spray patterns include 0 degrees, 15 degrees, 40 degrees, soap and flush for a complete clean
- For use with most brands of pressure washers up to 3,200 PSI
- Connects to quick-connect Wands



Model#	SKU#	Description
PWA004	10012307	Blushield 6-in-1 Nozzle

3/8" Quick-Disconnect Plug x 3/8" Male Pipe Thread Pressure Washer Adapter



Features:

- Includes: 3/8" quick-disconnect plug x 3/8" female pipe thread adapter, 3/8" quick-disconnect socket x 3/8" female pipe thread adapter
- Use Teflon tape or paste for a leak-free connection

Model#	SKU#	Description
PWA005	10012308	Blushield 3/8" Quick-Disconnect Plug x 3/8" Male Pipe Thread Pressure Washer Adapter

Male Metric x 3/8" Male Pipe Thread Pressure Washer Adapter



Features:

- Converts female pipe thread to a female metric connection
- Hex nut makes installation easy
- Use pipe thread tape to ensure a leak-free connection
- For use on pumps, injectors, hoses, etc

3/8" Female Pipe Thread x Female Metric Pressure Washer Adapter



Features:

- Converts male metric connection to 3/8" female pipe thread
- For use on wands, hoses, pumps, etc.
- Durable construction for pressure washer use
- Use pipe thread tape to ensure a leak-free connection

Model#	SKU#	Description
PWA006	10012309	Blushield Male Metric x 3/8" Male Pipe Thread Pressure Washer Adapter
PWA007	10012310	Blushield 3/8" Female Pipe Thread x Female Metric Pressure Washer Adapter

1/4" Female Pipe Thread x Female Metric Pressure Washer Adapter



Features:

- Converts male pipe thread to a male metric connection
- Attach and remove adapter quickly using the easy grip nut
- For use on wands, hoses, pumps, etc.
- Durable construction for pressure washer use

Male Metric x 1/4" Female Pipe Thread Pressure Washer Adapter



Features:

- Converts male pipe thread to a female metric connection
- For use on pumps, injectors, hoses, etc.
- Hex nut makes installation easy
- Durable construction for pressure washer use

Model#	SKU#	Description
PWA008	10012311	Blushield 1/4" Female Pipe Thread x Female Metric Pressure Washer Adapter
PWA009	10012312	Blushield Male Metric x 1/4" Female Pipe Thread Pressure Washer Adapter

1/4" Quick-Disconnect Plug x 1/4" Male Pipe Thread Pressure Washer Adapter



Features:

- End 1 Type: Quick-disconnect plug
- End 3 Type: Quick-disconnect socket
- Includes: 1/4" Quick-disconnect plug x 1/4" male pipe thread adapter, 1/4" quick-disconnect socket x 1/4" female pipe thread adapter
- 1/4-inches FPT connection

Model#	SKU#	Description
PWA010	10012313	Blushield 1/4" Quick-Disconnect Plug x 1/4" Male Pipe Thread Pressure Washer Adapter

65° Black Low Pressure Quick-Disconnect Soap Tip

Features:

- Black 65° spray tip applies soap pressure spray for pressure washer cleaning applications
- Connects directly to pressure washer wands with 1/4" quick-disconnect socket
- Quick-disconnect spray tips allow you the flexibility to select the specific spray tip pattern needed for your application



Model#	SKU#	Description
PWA011	10012314	Blushield 65° Black Low Pressure Quick-Disconnect Soap Tip

3.5 Orifice 40° Quick-Disconnect Pressure Washer Spray Tip



Features:

- White 40° spray tip is for use on painted surfaces or equipment
- Connects directly to pressure washer wands with 1/4" quick-disconnect socket
- Quick-disconnect spray tips allow you the flexibility to select the specific spray tip pattern needed for your application

Model#	SKU#	Description
PWA012	10012315	Blushield #3.5 Nozzle 40° Quick-Disconnect Pressure Washer Spray Tip

3.5 Orifice 25° Quick-Disconnect Pressure Washer Spray Tip

Features :

- Green 25° tips work on bare wood, siding, fences, and other similar surfaces
- Connects directly to pressure washer wands with 1/4" quick disconnect socket
- Quick-disconnect spray tips allow you the flexibility to select the specific spray tip pattern needed for your application



Model#	SKU#	Description
PWA013	10012316	Blushield #3.5 Nozzle 25° Quick-Disconnect Pressure Washer Spray Tip

3.5 Orifice 15° Quick-Disconnect Pressure Washer Spray Tip



Features :

- Yellow 15° tip is great for use on concrete, brick, and other hard or porous surfaces with stubborn stains
- Connects directly to pressure washer wands with 1/4" quick-disconnect socket
- Quick-disconnect spray tips allow you the flexibility to select the specific spray tip pattern needed for your application

Model#	SKU#	Description
PWA014	10012317	Blushield #3.5 Nozzle 15° Quick-Disconnect Pressure Washer Spray Tip

3.5 Orifice 0° Quick-Disconnect Pressure Washer Spray Tip

Features :

- Red 0° tip is ideal for cleaning or rinsing hard to reach areas crevices in sidewalks or driveways
- Connects directly to pressure washer wands with 1/4" quick-disconnect socket
- Quick-disconnect spray tips allow you the flexibility to select the specific spray tip pattern needed for your application



Model#	SKU#	Description
PWA015	10012318	Blushield #3.5 Nozzle 0° Quick-Disconnect Pressure Washer Spray Tip

Male Metric Pressure Washer Adapter



Features :

- Creates a connection between two female metric ends
- Heavy-duty plated steel or brass construction
- For use on guns, hoses, wands, and accessories
- Durable construction for pressure washer use

Female Metric x 3/8" Quick-Disconnect Plug/Socket Pressure Washer Adapter Set

Features :

- Converts male and female metric connections into 3/8" quick-disconnect connectors
- Adapters create a thread free connection between pump and hose
- Quick-disconnect feature allows for easy change out of accessories
- Durable construction for pressure washer use



Model#	SKU#	Description
PWA016	10012319	Blushield Male Metric Pressure Washer Adapter
PWA017	10012320	Blushield Female Metric x 3/8" Quick-Disconnect Plug/Socket Pressure Washer Adapter Set

Quick-Disconnect Garden Hose Adapter Set



Features :

- Allows quick and easy connection of garden hoses
- Heavy-duty brass construction for adapter durability
- Use to connect pressure washer supply, garden hoses, or accessories
- Quick-disconnect feature allows for easy change out of accessories

Cleaning Solution Siphon Hose and Filter

Features :

- Used to siphon detergent out of a separate container
- For use with most brands of pressure washers
- Includes a filter to ensure no contaminants enter the pressure washer pump
- Help keep your pressure washer running at peak performance
- Genuine OEM replacement part



Model#	SKU#	Description
PWA018	10012321	Blushield Quick-Disconnect Garden Hose Adapter Set
PWA019	10012322	Blushield Cleaning Solution Siphon Hose and Filter

Pressure Washer O-Ring Replacement Kit



Features:

- Simply twist for a full range of spray patterns from pin-point to wide fan (0 - 40 degrees)
- Easily adjust pressure from high to low for applying cleaning solutions
- For pressure washers up to 3,200 PSI
- Connects to M22 spray gun fittings 24.25 L x 4.50 W x 2.00 H



Model#	SKU#	Description
PWA020	10012323	Blushield O-Ring Kit
PWL001	10012324	Blushield Lance Assembly 18" with Hi-Lo #3.5 x M22

20" Lance Adjustable Spray Nozzle & Wand



Features:

- Adjustable spray nozzle and wand
- Up to 3000 PSI pressure washers and connects to M22 spray gun fittings
- Simply twist for a full range of spray patterns from pin-point to wide fan (0-40 degrees)
- Easily adjust from high to low for applying cleaning solutions
- Fits multiple brands

3000 PSI Multi-Tip Adjustable Pressure Washer Wand



Features:

- Comes with 6-in-1 nozzle
- Easy one click spray selection switches between 0°, 15°, 40°, and 65° spray patterns
- 18" wand connects to most consumer pressure washer units
- Male metric wand inlet

Model#	SKU#	Description
PWL002	10012325	Blushield 20" Lance Adjustable Spray Nozzle & Wand
PWL003	10012326	Blushield 3000 PSI Multi-Tip Adjustable Pressure Washer Wand

4000 PSI Easy-Lock Metric Quick-Disconnect Replacement Pressure Washer Wand



Features:

- Easy-lock quick-disconnect wand with lock down collar for quick, one-handed connections
- Provides an additional 20" length for high, hard to reach cleaning applications
- Quick-disconnect feature allows for quick, easy change outs of nozzles, tips, and other accessories
- Can be used as a replacement or extension wand

3000 PSI Metric Pressure Washer Gun



Features:

- For use with gas pressure washers
- Spray lance required; not included
- Inlet: M22 threaded male
- Outlet: M22 threaded female
- Maximum pressure: 3200 PSI
- Maximum flow: 8 GPM
- Maximum temperature: 200° F

Model#	SKU#	Description
PWL004	10012327	Blushield 4000 PSI Easy-Lock Metric Quick-Disconnect Replacement Pressure Washer Wand
PWG001	10012328	Blushield 3000 PSI Metric Pressure Washer Gun

Hot Water Pressure Washer Gun with Vented Lance — 5,000 PSI, 10 GPM, 16" Lance

Features:

- Vented design for hot water applications
- High-impact Zytel polymer cover
- Viton O-ring
- Chrome-plated lance with top M22 coupler and 3/8in. quick-connect inlet brass coupler
- Up to 5000 PSI at 300°F



Model#	SKU#	Description
PWG002	10012329	Blushield Hot Water Pressure Washer Gun with Vented Lance — 5,000 PSI, 10 GPM, 16" Lance

Gun/Lance 3200psi M22xM22



Features:

- Trigger lock helps prevent accidental spraying
- For use with metric wands and accessories

Model#	SKU#	Description
PWG003	10012330	Blushield Gun/Lance 3200psi M22xM22

Fuel Transfer Hoses & Reels



Fuel Transfer Hose

For use with diesel, gasoline, kerosene, bio diesel B10 and B20

8" Internal strain relief springs on each end to prevent kinking at the coupling

2x Kink resistant than other fuel hoses

Ozone and abrasion resistant cover

Static wire allows use with electric pumps

For use where UL approval is not required*



**100 PSI Burst Pressure
RMA Class A
oil-resistant tube & cover**



Award Winning Formulation



8" internal strain relief springs on each end to prevent kinking at the coupling



**1
YEAR
WARRANTY**

This product is intended to be used in applications where UL approval is not required.

Model#	Description	I.D.(in.)	Length (ft.)	Fitting
OSFH3410	OilShield Farm Fuel Hose 3/4" x 10'	3/4	10	3/4 Male NH
OSFH3412	OilShield Farm Fuel Hose 3/4" x 12'	3/4	12	3/4 Male NH
OSFH3420	OilShield Farm Fuel Hose 3/4" x 20'	3/4	20	3/4 Male NH
OSFHONE10	OilShield Farm Fuel Hose 1" x 10'	01	10	3/4 Male NH
OSFHONE12	OilShield Farm Fuel Hose 1" x 12'	01	12	3/4 Male NH
OSFHONE20	OilShield Farm Fuel Hose 1" x 20'	01	20	3/4 Male NH
OSFHONE50	Oilshield Rubber Fuel Hose 1" x 50'	01	50	3/4 Male NH

18 ga. Heavy-Duty Fuel Transfer Hose Reels

Constructed with 18 gauge heavy-duty steel & ribbed edges, our fuel transfer hose reel ensure strength, durability and operator safety. It provides stability and reliability in any environment.

Specialized internal system to reduce vibration and offer stability
Includes 6ft. lead-in hose



Smooth auto-rewind with locking 12 point ratchet gearing system.



Four rollers reduce hose wear & tear



1
YEAR
WARRANTY

Mounting Options:

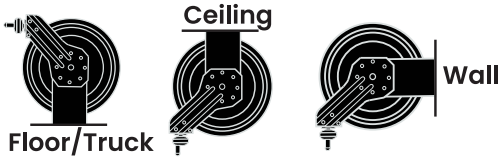

Dual-Arm Construction for extreme stability



Model#	Description	I.D.(in.)	Length (ft.)	Fitting
OSFHR3425	Oilshield Fuel Hose Reel 3/4" x 25'	3/4"	25'	Outlet - 3/4" NH & Reel Inlet 3/4" NH
OSFHR3435	Oilshield Fuel Hose Reel 3/4" x 35'	3/4"	35'	Outlet - 3/4" NH & Reel Inlet 3/4" NH
OSFHRONE25	Oilshield Fuel Hose Reel 1" x 25'	1"	25'	Outlet - 3/4" NH & Reel Inlet 3/4" NH
OSFHRONE50	Oilshield Fuel Hose Reel 1" x 50'	1"	50'	Outlet - 3/4" NH & Reel Inlet 3/4" NH



Accessories



BluBird **Rapid TIE** 

BluBird® Rapid TIE™

Non marking Flexible
Vinyl Tie

2
YEAR
WARRANTY

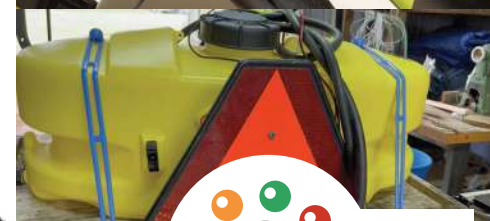

Easily Expandable

Utilize unique fastening techniques to get the perfect length of the strap you need

- Easy to store and won't tangle like ropes
- 100% Quality tested
- Stretches up to 50% of its length
- Oil resistant
- Non conductive
- **No violent recoil like rubber straps and bungee cords**

Counter Display
Pack of 48



Display Box
Pack of 24



Flexible from
-60°F to 200°F



Adjustable
Tension



Non-marring



Easily Links
Together



UV and Ozone
Resistant









Stretch to
Soften

Model#	SKU#	Description	Pack	Color
BBRT01-BL	10012066	Blubird 'Rapid Tie' Non Marring Strap 16"	2	Blue
BBRT01-BK	10012067	Blubird 'Rapid Tie' Non Marring Strap 16"	2	Black
BBRT01-RD	10012068	Blubird 'Rapid Tie' Non Marring Strap 16"	2	Red
BBRT01-YL	10012069	Blubird 'Rapid Tie' Non Marring Strap 16"	2	Yellow
BBRT01-GN	10012070	Blubird 'Rapid Tie' Non Marring Strap 16"	2	Green
BBRT01-OR	10012071	Blubird 'Rapid Tie' Non Marring Strap 16"	2	Orange
BBRT01-BG	10012072	Blubird 'Rapid Tie' Non Marring Strap 16"	2	Beige
BBRT01-WT	10012073	Blubird 'Rapid Tie' Non Marring Strap 16"	2	White
BBRT01-10-BL	10012074	Blubird 'Rapid Tie' Non Marring Strap 16"	10	Blue
BBRT01-10-BK	10012075	Blubird 'Rapid Tie' Non Marring Strap 16"	10	Black
BBRT01-10-RD	10012076	Blubird 'Rapid Tie' Non Marring Strap 16"	10	Red
BBRT01-10-YL	10012077	Blubird 'Rapid Tie' Non Marring Strap 16"	10	Yellow
BBRT01-10-GN	10012078	Blubird 'Rapid Tie' Non Marring Strap 16"	10	Green
BBRT01-10-OR	10012079	Blubird 'Rapid Tie' Non Marring Strap 16"	10	Orange
BBRT01-10-BG	10012080	Blubird 'Rapid Tie' Non Marring Strap 16"	10	Beige
BBRT01-10-WT	10012081	Blubird 'Rapid Tie' Non Marring Strap 16"	10	White
BBRTDP-2-MX48	10012242	Rapid Tie Displayer with Mix Pcs	48x2	All Colors
BBRTCDP-8-MX24	10012412	Rapid Tie Counter Display 24-2 Pack	24	All Colors
BBRTDP-MX	10012206	Rapid Tie Displayer	2	-



Features

- Nonslip ridges for a firm grip
 - UV, oil, salt and acid-resistant for use in situations with corrosive chemicals
 - Includes eyebolt & handles for easy carrying or to connecting two chocks
 - Wide base for increased stability and rigidity
- Heavy-duty rubber constructed wheel chock for lasting life

	Model#	SKU#	Description	L X W X H
	BBRWC01	10010530	Double Sided Pyramid Wheel Chock with Eye bolt	8.5x 7.25 x 5.5
	BBRWC02	10010531	Rubber Wheel Chock with Eye Bolt	8x 5x 4
	BBRWC03	10010532	Rubber Wheel Chock with Handle	8x7.5x4
	BBRWC04	10010533	Contured Wheel Chock with Eye Bolt	10x 7 x 8.5
	BBRWC05	10010534	Aircraft Wheel Chocks Rubber	10 x 5x 4.5
	BBRWC06	10010535	2-Pack of Rubber Wheel Chocks with Eyebolt	6.5x 4 x4
	BBRWC07	10010536	2-Pk. of Compact Wheel Chocks	5 x 3x 2.75

Work Gear

POLYESTER WORK GEAR

Work Gear is our new line of Tool Bags & Pouches. These bags and pouches are tailor made to fit the needs of professional as well as a do-it-yourselfer.



- Virtually “untearable” stitching
- Rubber foam and hard bottoms to protect the bags from hard falls
- Adjustable compression pocket to carry bulky items
- Made with 600D polyester sewn together with heavy duty sticking for maximum durability.

Polyester work gears consist of several pockets and also comes with padded or hard bottoms. Pockets can hold multitude of tools & accessories like drills, pliers, screw-drivers, wrench-sets and much more



Model#

SKU#

Color

BBTB01

10010547

Black



Blubird Work Gear – Tool Backpack with 48 pockets

H: 16" | W: 12" | D: 10"
Pockets : 48 | Shoulder Strap Length: 38"
Product weight : 4 lbs

Model#

SKU#

Color

BBTB02

10010549

Black



Blubird Work Gear – Hard Bottom Tool Bag with 22 pockets

H: 10.5" | W: 12.5" | D: 7.5"
Pockets : 21 | Shoulder Strap Length: 47"
Product weight : 2.27 lbs

Model#

SKU#

Color

BBTB03

10010551

Black



Blubird Work Gear – Large Hard Bottom Tool Bag with 31 pockets

H: 11" | W: 16" | D: 9.5"
Pockets : 31 | Shoulder Strap Length: 47"
Product weight : 3.03 lbs

Model#	SKU#	Color
BBTB04	10010552	Black



BluBird Work Gear – Medium and Large Utility Tote Bag Combo ! Product weight : 1.52 lbs

Big
H: 5.5" | W: 14" | D: 5.5"
Pockets :1

Small
H: 5" | W: 12" | D: 4"
Pockets :1

Model#	SKU#	Color
BBTB05	10010553	Black / Blue



Blubird Work Gear – Multi pocket Tool Role Organizer with 32 pockets

H: 14.5" | W: 27.5" | Pockets : 14
Strap Length: 32"
Product weight : 0.93 lbs

Model#	SKU#	Color
BBTB06	10010554	Black / Blue

Blubird Work Gear – Diagonal Strap Tool Bag with 14 pockets

H: 12" | W: 14" | D: 2"
Pockets : 14 | Strap Length: 31"
Waist Size (max) : 48"
Product weight : 1.07 lbs



Model#

SKU#

Color

BBTB07

10010555

Black / Blue



Blubird Work Gear - Tool Pouch with 11 pockets

H: 13" | W: 13" | D: 2.5"
Pockets : 11 | Belt Loop : 4"
Product weight : 1.30 lbs

Model#

SKU#

Color

BBTB08

10010557

Black / Blue



Blubird Work Gear Multipocket tool Apron with 14 pockets

H: 22.5" | W: 21.75" | Pockets : 14
Neck Strap : 31" | Waist Size (max) : 50"
Product weight : 0.94 lbs

Model#

SKU#

Color

BBTB09

10010558

Black / Blue



Blubird Work Gear - Belt Tool pouch with 9 pockets

H: 12.25" | W: 13" | Pockets : 5
Holders : 5 | Belt Loop : 4"
Product weight : 0.58 lbs

Model#

SKU#

Color

BBTB10

10010559

Black \ Blue



Blubird Work Gear – Belt pocket tool pouch with 4 pockets

H: 10.5" | W: 10" | Pockets : 4
 Belt Loop : 4"
 Product weight : 0.45 lbs

Model#

SKU#

Color

BBTB11

10010560

Black / Blue



Blubird Work Gear – Nail Pouch single pocket

H: 9.75" | W: 7.5"
 Pockets : 1 | Belt Loop : 3"
 Product weight : 0.27 lbs

Model#

SKU#

Color

BBTB12

10010561

Black



Blubird Work Gear – Tool Roll Pouch with 36 pockets

H: 20" | W: 16" | Holders : 16
 Pockets : 20 | Belt Loop : 3"
 Product weight : 0.83 lbs

Model#	SKU#	Color
--------	------	-------

BBTB13

10010562

Black

Blubird Work Gear - Multi-purpose clip-on zippered poly bags, 3 pack | Weight: 0.33 lbs



Big

H: 7"

W: 8.5"

Pockets : 1

Medium

H: 6.25"

W: 6.5"

Pockets : 1

Small

H: 4.75"

W: 5.75"

Pockets : 1

Model#	SKU#	Color
--------	------	-------

BBTB14

10010563

Black

Blubird Work Gear - Cordless Drill Holster with 14 pockets

H: 12.5" | W: 7.25"

Holders : 15

Belt Loop : 3.25"

Product weight : 0.48 lbs



Model#	Color
--------	-------

BBTB015

Black

PLIER POUCH

H: 10" | W: 4.5"

Pocket : 1

Belt Loop : 3"

Product weight : 0.28 lbs





A DIVISION OF



Visit Website

Contact us:

sales@blubirdindustries.com | tel:+1.844.769.4673

30 N Gould St Ste 4025 Sheridan, WY 82801

BluBird, OilShield, BluShield, BluSeal, AG-Lite & Avagard are registered trademarks of RMX Industries pvt. ltd.