

Invacare® Platinum® Mobile

POC1-100B, POC1-100C

en **Oxygen Concentrator
User Manual**

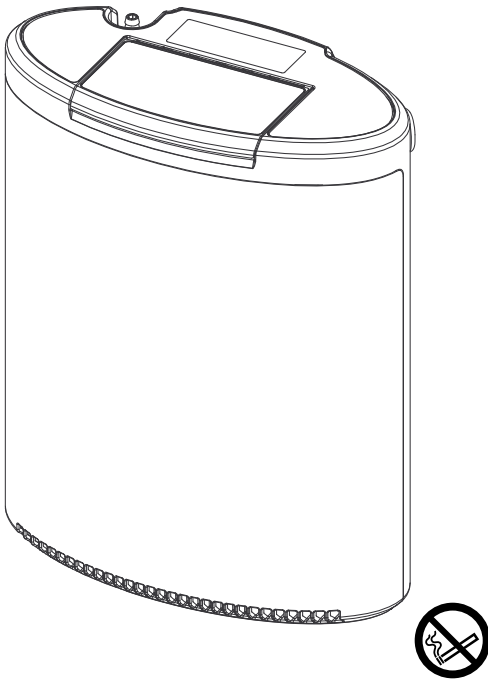

This manual **MUST** be given to the user of the product.
BEFORE using this product, this manual **MUST** be read and saved for
future reference.



Yes, you can.®

©2018 Invacare Corporation

All rights reserved. Republication, duplication or modification in whole or in part is prohibited without prior written permission from Invacare. Trademarks are identified by ™ and ®. All trademarks are owned by or licensed to Invacare Corporation or its subsidiaries unless otherwise noted.

Platinum is a registered trademark in the U.S.A., Europe and Australia.

Making Life's Experiences Possible is a registered trademark in the U.S.A.

Pine-sol, Lestoil and Clorox are registered trademarks of The Clorox Company.

Dawn is a registered trademark of The Procter and Gamble Company.

IOS is a trademark or registered trademark of Cisco in the U.S. and other countries and is used under license to Apple, Inc.

Android is a trademark of Google, LLC.

Bluetooth is a registered trademark of Bluetooth SIG, Inc.

Contents

1 General	5
1.1 Quick Start Guide	5
1.2 Symbols	9
1.3 Indications For Use	11
1.4 Intended Use	11
1.5 Contraindications	11
1.6 Features	12
1.6.1 Control Panel	12
1.6.2 Input/Output Connections	13
1.6.3 Filters	13
1.6.4 Power Options	14
1.6.5 Carry Bag	14
1.7 Optional Accessories and Replacement Parts	14
2 Safety	15
2.1 Label Locations	15
2.2 General Guidelines	17
2.3 Radio Frequency Interference	22
2.4 Traveling with the Concentrator	22
3 Setup	25
3.1 Unpacking	25
3.2 Inspection	25
3.3 Powering the Oxygen Concentrator	25
3.3.1 Installing the Battery(s)	26
3.3.2 Charging the Battery(s)	27
3.3.3 Reading the Battery Gauge for Installed and Uninstalled Battery(s)	28
3.3.4 Removing the Battery(s)	29
3.3.5 External AC Power	30
3.3.6 External DC Power	30
3.4 Carry Bag Setup	31
3.4.1 Installing the Carry Bag	31
3.4.2 Removing the Carry Bag	32
3.4.3 Installing Shoulder Straps	32
3.5 Connecting/Positioning the Nasal Cannula	33
4 Usage	35
4.1 Location	35
4.2 Concentrator Operating Position	35
4.3 Using the Carry Bag	35
4.4 Turning On the Concentrator	36
4.5 Turning Off the Concentrator	37
4.6 Warm Up Period	37
4.7 Breathing with the Use of the Concentrator	37
4.8 Reading the Display Screen	37
4.9 Adjusting the Pulse Flow Setting	38
4.10 Battery Life and Management	39
5 Maintenance	41
5.1 Maintenance	41
5.2 Service Life	41
5.3 Cleaning the Cabinet	41
5.4 Cleaning the Air Intake Filter Screen	42
5.5 Cleaning the Carry Bag	42
5.6 Cleaning and Disinfection Between Patients	43
5.7 Viewing Hour Meter	44
5.8 Preventative Maintenance Checklist	45
6 After Use	47
6.1 Storage	47
6.2 Disposal	47
6.3 Wear and Tear	48
7 Troubleshooting	49
7.1 Troubleshooting	49
7.2 Alarm Conditions	51
7.2.1 Operational Alarms	52
7.2.2 Shut Down Alarms	60
8 Technical Data	65
8.1 Technical Description	65
8.1.1 Pneumatic Diagram	65

8.2	Specifications	66
8.3	Regulatory Listing	70
8.4	Electromagnetic Compliance (EMC)	71
9	Warranty	76
9.1	Limited Warranty	76

1 General

1.1 Quick Start Guide



IMPORTANT!

- The Quick Start Guide is for reference ONLY. It is imperative to read the manual in its ENTIRETY for full instructions.



DANGER!

Risk of Death, Injury, from Electric Shock

To reduce the risk of burns, electrocution, death or injury to persons:

- DO NOT disassemble. Refer servicing to qualified service personnel. There are no user serviceable parts.



WARNING!

Risk of Injury or Damage

Use of this product outside of the intended use and specifications has not been tested and may lead to product damage, loss of product function, or injury.

- DO NOT use this product in any way other than described in the specifications and intended use sections of this manual.



DANGER!

Risk of Death, Injury Or Damage From Fire

Textiles, oil or petroleum substances, grease, greasy substances and other combustibles are easily ignited and burn with great intensity in oxygen enriched air and when in contact with oxygen under pressure. Smoking during oxygen therapy is dangerous and is likely to result in burns or death. To avoid fire, death, injury or damage:

- DO NOT SMOKE while using this device. DO NOT use near OPEN FLAME or IGNITION SOURCES.
- NO SMOKING signs should be prominently displayed.
- Avoid creation of any spark near oxygen equipment. This includes sparks from static electricity created by any type of friction.
- Use only oxygen compatible water-based lotions or salves before and during oxygen therapy. To verify, refer to the lotion/salve container for oxygen compatible water-based statement. If necessary, contact the manufacturer. DO NOT use any lubricants on concentrator unless recommended by Invacare.
- Keep the oxygen tubing, cord, AC adapter, and concentrator out from under such items as blankets, bed coverings, chair cushions, clothing, and away from heated or hot surfaces including space heaters, stoves, and similar electrical appliances.
- Make sure concentrator is off when not in use.







DANGER!

Risk Of Death, Injury Or Damage

Improper use of the product may cause death, injury or damage. This section contains important information for the safe operation and use of this product.

- DO NOT use this product or any available optional equipment without first completely reading and understanding these instructions and any additional instructional material such as user manuals, service manuals or instruction sheets supplied with this product or optional equipment.
- If you are unable to understand the warnings, cautions or instructions, contact a health care professional, dealer or technical personnel before attempting to use this equipment.
- Check ALL external components and carton for damage. In case of damage, or if the product is not working correctly, contact a technician or Invacare for repair.
- This product is intended to be used by adults only after reading and understanding the instructions and warnings of this user manual.
- THE INFORMATION IN THIS DOCUMENT IS SUBJECT TO CHANGE WITHOUT NOTICE.

<p>1.</p>	<p>Open the battery compartment door. With battery fuel gauge label facing toward the front of the oxygen concentrator, slowly lower battery A straight down into one of the two slots in the battery compartment.</p> <p>Refer to Installing the Battery(s) in Setup.</p>	
<p>2.</p>	<p>Connect the AC Power Adapter to the external power input connector B. Plug the AC cord into the electrical outlet.</p> <p>Refer to External AC Power in Setup.</p> <p> Using the concentrator for the first time requires the battery(s) to be charged. Refer to Charging the Battery(s) in Setup.</p>	
<p>3.</p>	<p>Connect the nasal cannula to the concentrator oxygen outlet port on your concentrator C. Oxygen will only be delivered while you are breathing through the nasal cannula connected to this device.</p> <p>Refer to Connecting/Positioning the Nasal Cannula in Setup.</p>	

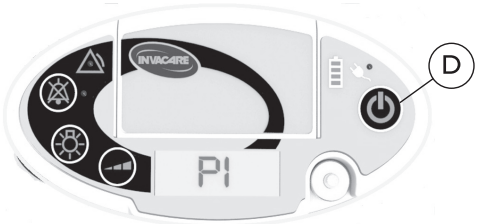
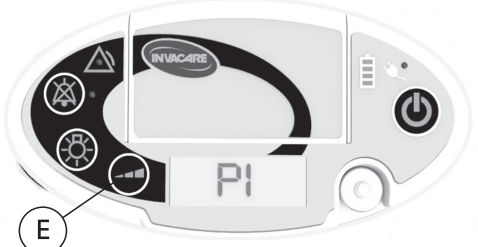
<p>4.</p>	<p>Turn on the concentrator by pressing the On/Off Button (D) until the control panel indicators light up.</p> <p>Refer to Turning on the Concentrator in Usage.</p>	 <p>The diagram shows the top control panel of the Invacare Platinum Mobile concentrator. It features a central LCD screen displaying 'PI'. To the left of the screen are four circular buttons with icons: a triangle, a star, a sun, and a speaker. To the right of the screen is a power button labeled 'D', a battery level indicator, and a small arrow icon. The brand name 'INVACARE' is printed above the screen.</p>
<p>5.</p>	<p>Adjust the pulse flow setting to the one prescribed by your clinical professional. The pulse flow setting can be changed by pressing the flow selection button (E). Place the nasal cannula over your ears and position the prongs in your nose as instructed by your health care provider.</p> <p>Refer to Adjusting the Pulse Flow Setting in Usage.</p>	 <p>This diagram is identical to the one above, showing the control panel with the LCD screen displaying 'PI'. In this image, the flow selection button, which is the bottom-most button on the left side with a bar chart icon, is highlighted with a circle labeled 'E'.</p>

1.2 Symbols

Signal words are used in this manual and apply to hazards or unsafe practices which could result in personal injury or property damage. Refer to the information below for definitions of the signal words.



DAANGER!

– Danger indicates an imminently hazardous situation which, if not avoided, will result in death or serious injury.



WARNING!

– Warning indicates a potentially hazardous situation which, if not avoided, could result in death or serious injury.



CAUTION!

– Caution indicates a potentially hazardous situation which, if not avoided, may result in property damage or minor injury or both.



IMPORTANT!













– Important indicates a hazardous situation that could result in damage to property if it is not avoided.









Gives useful tips, recommendations and information for efficient, trouble-free use.

Refer to the following table for the meaning of symbols marked on the equipment and/or packaging.

	<p>General Warning Sign</p> <p> The background color inside the triangle is yellow on product labels.</p>
	<p>Follow Instructions for Use</p> <p> The color of the symbol background is blue on product labels.</p>
	<p>No open flame</p> <p> The color of the circle with diagonal bar is red on product labels.</p>
	<p>DO NOT Smoke</p> <p> The color of the circle with diagonal bar is red on product labels.</p>
	<p>Consult Instructions for Use</p> <p> This symbol is located on the cannula packing.</p>
	<p>Direct Current</p>
	<p>Type BF Applied Part</p>

	Class II Equipment
	Power On/Off
	Data Output Terminal
	DO NOT dispose of in household waste
	Manufacturer
	Date of Manufacture
	Recycle
	Reference Number
	Serial Number
	DO NOT Reuse (Single Patient Use Only)  This symbol refers to the cannula which is for single patient use only.
	Latex Free

	Indoor Use ONLY  This symbol is included on the AC power adapter.
	DO NOT use oil or grease
	Keep dry
IP22	Protected against solid foreign objects of 12.5 mm diameter and greater. Protected against vertically falling water drops when enclosure tilted up to 15°.
IP21	Protected against solid foreign objects of 12.5 mm diameter and greater. Protected against vertically falling water drops.
	Transport and Storage Temperature
	Transport and Storage Humidity
	Electrical Safety Agency Certification Mark

1.3 Indications For Use

The Invacare® Platinum® Mobile Oxygen Concentrator is intended to provide supplemental oxygen to patients with respiratory disorders. The device can be used in a home, institution, vehicle, or other environments outside the home.

The Invacare Mobile Medical Application Accessory POC1-CONNECT is intended for use with the Invacare Platinum Mobile Oxygen Concentrator POC1-100B or POC1-100C device, to allow patients via their Android™ or iOS™ mobile phone or tablet to display device settings, and to collect device performance and usage information for maintenance/servicing purposes only.

1.4 Intended Use

The Invacare® Platinum® Mobile Oxygen Concentrator is intended to provide supplemental oxygen to patients with respiratory disorders. The Invacare® Platinum® Mobile Oxygen Concentrator can be used in a home, institution, vehicle, or other environments outside the home. The device is not intended to be life-supporting or life-sustaining.

The Invacare Mobile Medical Application Accessory POC1-CONNECT is intended to allow patients via their Android or iOS mobile phone or tablet to display device settings, and to collect device performance and usage information for maintenance/servicing purposes only.



WARNING!

Risk of Injury or Damage

Use of this product outside of the intended use and specifications has not been tested and may lead to product damage, loss of product function, or personal injury.

- DO NOT use this product in any way other than described in the specifications and intended use sections of this manual.

1.5 Contraindications



WARNING!

Risk of Injury

This product is to be used as an oxygen supplement and is not intended to be life-supporting or life-sustaining. ONLY use this product if the patient is capable of spontaneous breath, able to inhale and exhale without the use of a machine

- DO NOT use in parallel or series with other oxygen concentrators or oxygen therapy devices.



WARNING!

Risk of Minor Injury or Discomfort

The conserving, or pulse dose, oxygen delivery technique used by this device is contraindicated in persons whose breathing during normal resting would be unable to trigger the device.

- Proper device triggering, setup and operation must be confirmed by an experienced clinician or other respiratory professional.
- Not for pediatric use.
- Not for use by tracheotomized patients.

1.6 Features

1.6.1 Control Panel

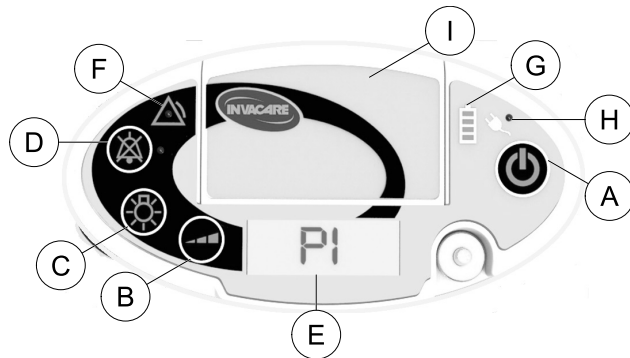

(A)	<p>On/Off Button</p> <p>Press for one second to turn concentrator on or off.</p>
(B)	<p>Flow Selection Button</p> <p>Press to adjust the pulsed oxygen flow to your prescribed setting. The selected flow setting is shown on the display screen. Refer to Adjusting the Pulse Flow Setting in Usage for more details.</p>
(C)	<p>Display Backlight Button</p> <p>Press once to illuminate the display screen for 5 seconds.</p>
(D)	<p>Audio Off Button</p> <p>Press to mute the audible signal (beep) for both alarms and status indications. The blue indicator light next to the button illuminates when activated. Audio off can be activated during or prior to an alarm condition occurring.</p>
(E)	<p>Display Screen</p> <p>Displays information about the operating status of the concentrator.</p>
(F)	<p>Alarm Indicator</p> <p>The yellow indicator light at the center of the triangular symbol illuminates to indicate abnormal operating conditions. Refer to Alarm Conditions in Troubleshooting for more details.</p>

Ⓒ	<p>Battery Gauge</p> <p>Indicates the charge status of the battery(s). Refer to Reading the Battery Gauge for Installed and Uninstalled Battery(s) in Setup for more details.</p>
Ⓓ	<p>External Power Indicator</p> <p>The orange indicator light next to the plug symbol illuminates when an external power source is connected to the concentrator.</p>
①	<p>Battery Compartment Door</p> <p>Used to access the removable battery(s).</p>

Not Shown	<p>Audible Signal (Beep)</p> <p>Indicates a change in operating status or a condition which requires the operator’s attention.</p>
-----------	---

1.6.2 Input/Output Connections

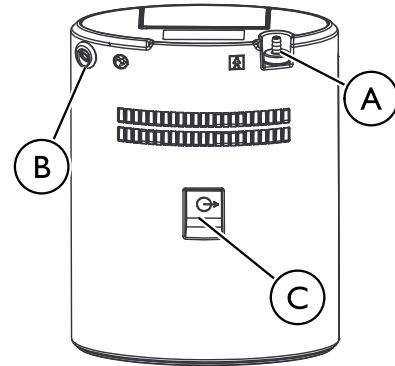

Ⓐ	<p>Oxygen Outlet Port</p> <p>Used to connect the nasal cannula to the concentrator.</p>
Ⓑ	<p>External Power Input Connector</p> <p>Used to connect an external power source to the concentrator.</p>
Ⓒ	<p>USB Port</p> <p>Used for service. Location of POC1–CONNECT Dongle.</p>

1.6.3 Filters

Air enters the concentrator through an air intake filter located on the carry bag. This filter prevents hair and other large particles in the air from entering the unit. Before you

operate the concentrator, make sure this filter is clean and dry, and the concentrator is properly installed in the carry bag.

To clean the air intake filter, refer to Cleaning the Air Intake Filter Screen in Maintenance.

To ensure the concentrator is properly installed in the carry bag, refer to Installing the Carry Bag in Setup.

1.6.4 Power Options



WARNING!

Risk of Injury or Damage

To avoid injury or damage which will void warranty:

- Use only Invacare specified power supplies.

Battery(s): Up to two rechargeable batteries can be installed in the battery compartment of the concentrator. When fully charged, a single battery supplies power for up to five hours (up to ten hours for two batteries). Visible and audible alarm signals occur when the battery power is getting low. Refer to Alarm Conditions in Troubleshooting and Charging the Battery(s) in Setup.

AC Power Adapter: An AC power adapter allows the concentrator to be connected to a 100–240 volt 50–60 hertz outlet. Use of the AC power adapter will allow the concentrator to operate and simultaneously recharge the installed battery. Refer to Charging the Battery(s) in Setup.

DC Power Cable: A DC power cable allows the concentrator to be connected to an automobile's (boat, motor home, etc.) 12-volt DC outlet. Use of the DC power cable will allow

the concentrator to operate and simultaneously recharge an installed battery(s). Refer to Charging the Battery(s) in Setup.

1.6.5 Carry Bag

The carry bag provides a convenient means to hold the concentrator while performing daily activities.

It can be configured as a messenger bag or backpack using the shoulder straps provided. Refer to Installing the Carry Bag in Setup.

1.7 Optional Accessories and Replacement Parts

The following optional accessories are available from Invacare:

- Additional batteries, model number: POC1–110
- External battery charger with power supply: POC1–115

The following replacement parts are available from Invacare:

- Battery, model number: POC1–110
- Carry Bag, model number: POC1–150
- DC power cable, model number: POC1–140
- AC power adapter with power cord: POC1–130
- USB Dongle, model number: POC1–CONNECT



These parts are base models. Please contact Invacare or your provider for country specific models.

2 Safety

2.1 Label Locations

 The label is located on the back of the concentrator. The serial number is located on the right side of label shown here.

Model POC1-100B

The concentrator has four pulse flow settings.

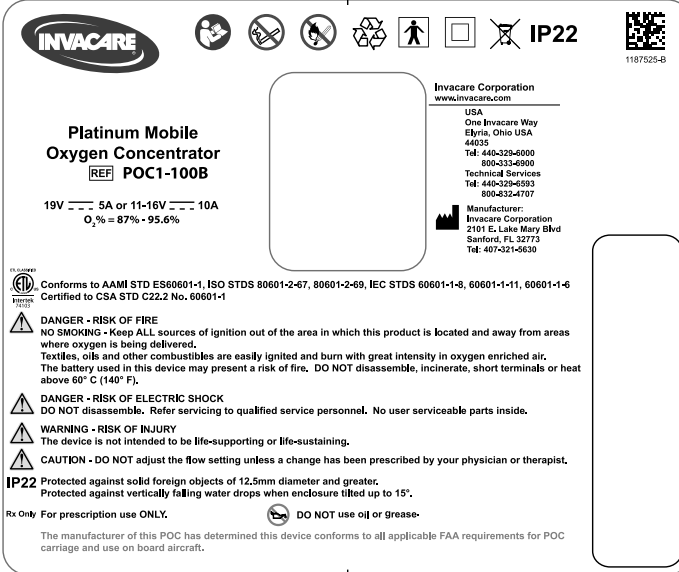

INVACARE

**Platinum Mobile
Oxygen Concentrator**
REF POC1-100B

19V --- 5A or 11-16V --- 10A
O₂ % = 87% - 95.6%

Invacare Corporation
www.invacare.com

USA
One Invacare Way
Elyria, Ohio USA
44035
Tel: 440-329-6000
800-333-6900
Technical Services
Tel: 440-329-6593
800-632-4707

Manufacturer:
Invacare Corporation
2101 E. Lake Mary Blvd
Sanford, FL 32773
Tel: 407-321-5630

1187525-B

Conforms to AAMI STD ES60601-1, ISO STDS 80601-2-67, 80601-2-69, IEC STDS 60601-1-8, 60601-1-11, 60601-1-6
Certified to CSA STD C22.2 No. 60601-1

⚠ DANGER - RISK OF FIRE
NO SMOKING - Keep ALL sources of ignition out of the area in which this product is located and away from areas where oxygen is being delivered.
Textiles, oils and other combustibles are easily ignited and burn with great intensity in oxygen enriched air. The battery used in this device may present a risk of fire. DO NOT disassemble, incinerate, short terminals or heat above 60° C (140° F).

⚠ DANGER - RISK OF ELECTRIC SHOCK
DO NOT disassemble. Refer servicing to qualified service personnel. No user serviceable parts inside.

⚠ WARNING - RISK OF INJURY
The device is not intended to be life-supporting or life-sustaining.

⚠ CAUTION - DO NOT adjust the flow setting unless a change has been prescribed by your physician or therapist.

IP22 Protected against solid foreign objects of 12.5mm diameter and greater.
Protected against vertically falling water drops when enclosure tilted up to 15°.

Rx Only For prescription use ONLY.  DO NOT use oil or grease-

The manufacturer of this POC has determined this device conforms to all applicable FAA requirements for POC carriage and use on board aircraft.

Model POC1-100C

The concentrator has five pulse flow settings.



**Platinum Mobile
Oxygen Concentrator**
REF **POC1-100C**

19V --- 5A or 11-16V --- 10A
O₂ % = 87% - 95.6%



IP22





60101892-A

Invacare Corporation
www.invacare.com

USA
One Invacare Way
Elyria, Ohio USA
44035
Tel: 440-329-6000
800-333-6900
Technical Services
Tel: 440-329-6593
800-832-4197

Invacare Corporation
2101 E. Lake Mary Blvd
Sanford, FL 32773
Tel: 407-321-5630

 Conforms to AAMI STD ES60601-1, ISO STDS 80601-2-67, 80601-2-69, IEC STDS 60601-1-8, 60601-1-11, 60601-1-6
Certified to CSA STD C22.2 No. 60601-1

 **DANGER - RISK OF FIRE**
NO SMOKING - Keep ALL sources of ignition out of the area in which this product is located and away from areas where oxygen is being delivered.
Textiles, oils and other combustibles are easily ignited and burn with great intensity in oxygen enriched air. The battery used in this device may present a risk of fire. **DO NOT** disassemble, incinerate, short terminals or heat above 60° C (140° F).

 **DANGER - RISK OF ELECTRIC SHOCK**
DO NOT disassemble. Refer servicing to qualified service personnel. No user serviceable parts inside.

 **WARNING - RISK OF INJURY**
The device is not intended to be life-supporting or life-sustaining.

 **CAUTION - DO NOT** adjust the flow setting unless a change has been prescribed by your physician or therapist.
IP22 Protected against solid foreign objects of 12.5mm diameter and greater.
Protected against vertically falling water drops when enclosure tilted up to 15°.

Rx Only For prescription use ONLY.  **DO NOT** use oil or grease.

The manufacturer of this POC has determined this device conforms to all applicable FAA requirements for POC carriage and use on board aircraft.

2.2 General Guidelines

In order to ensure the safe installation, assembly and operation of the concentrator these instructions **MUST** be followed.



DANGER!

Risk Of Death, Injury Or Damage

Improper use of the product may cause death, injury or damage. This section contains important information for the safe operation and use of this product.

- DO NOT use this product or any available optional equipment without first completely reading and understanding these instructions and any additional instructional material such as user manuals, service manuals or instruction sheets supplied with this product or optional equipment.
- If you are unable to understand the warnings, cautions or instructions, contact a health care professional, dealer or technical personnel before attempting to use this equipment.
- Check ALL external components and carton for damage. In case of damage, or if the product is not working correctly, contact a technician or Invacare for repair.
- This product is intended to be used by adults only after reading and understanding the instructions and warnings of this user manual.
- THE INFORMATION IN THIS DOCUMENT IS SUBJECT TO CHANGE WITHOUT NOTICE.



DANGER!

Risk of Death, Injury Or Damage From Fire

Textiles, oil or petroleum substances, grease, greasy substances and other combustibles are easily ignited and burn with great intensity in oxygen enriched air and when in contact with oxygen under pressure. Smoking during oxygen therapy is dangerous and is likely to result in burns or death. To avoid fire, death, injury or damage:

- DO NOT SMOKE while using this device. DO NOT use near OPEN FLAME or IGNITION SOURCES.
- NO SMOKING signs should be prominently displayed.
- Keep all open flames, matches, lighted cigarettes, electronic cigarettes or other sources of ignition at least 10 ft (3 m) away from this concentrator or any oxygen carrying accessories such as cannulas or tanks.
- If you disregard these warnings about the severe hazard of oxygen use while you continue to smoke, you must always turn off the concentrator, remove the cannula and then wait ten minutes before smoking or leave the room where either the concentrator or any oxygen carrying accessories such as cannulas or tanks are located.
- DO NOT SMOKE while using the concentrator.



CAUTION!

Federal (statutory) law restricts this device to sale by or on the order of a medical practitioner licensed by a governmental agency where he/she practices.

- ONLY a licensed medical practitioner may order the purchase or use of this device.



DANGER!

Risk of Death, Injury Or Damage From Fire

Textiles, oil or petroleum substances, grease, greasy substances and other combustibles are easily ignited and burn with great intensity in oxygen enriched air and when in contact with oxygen under pressure. To avoid fire, death, injury or damage:

- Avoid creation of any spark near oxygen equipment. This includes sparks from static electricity created by any type of friction.
- Use only oxygen compatible water-based lotions or salves before and during oxygen therapy. To verify, refer to the lotion/salve container for oxygen compatible water-based statement. If necessary, contact the manufacturer. DO NOT use any lubricants on concentrator unless recommended by Invacare.
- Keep the oxygen tubing, cord, AC adapter, and concentrator out from under such items as blankets, bed coverings, chair cushions, clothing, and away from heated or hot surfaces including space heaters, stoves, and similar electrical appliances.
- Make sure concentrator is off when not in use.

**CAUTION!****Risk of Minor Injury or Discomfort**

It is important to plan ahead for travel and other situations in which you may not have access to additional oxygen or power supplies. To prevent oxygen deprivation:

- Carry supplemental batteries with you.
- Stow the concentrator properly during travel.
For proper storage instructions when travelling refer to the travel guide.

**WARNING!****Risk of Injury or Damage**

To prevent injury or damage from misuse:

- NEVER leave concentrator unattended when connected to power.
- Make sure concentrator is off when not in use.
- Outdoor use MUST be conducted with internal battery power only.

**WARNING!****Risk Of Injury Or Damage**

- Invacare products are specifically designed and manufactured for use in conjunction with Invacare provided or Invacare specified accessories. Any other accessories have not been tested by Invacare and are not recommended for use with Invacare products.
- No modification of this equipment is allowed.

**CAUTION!****Risk of Minor Injury or Discomfort**

A change in altitude may affect total oxygen available to you. To prevent oxygen deprivation:

- Consult your physician before traveling to higher or lower altitudes to determine if your flow settings should be changed.

**DANGER!****Risk of Death, Injury, from Electric Shock**

To reduce the risk of burns, electrocution, death or injury to persons:

- DO NOT disassemble. Refer servicing to qualified service personnel. There are no user serviceable parts.
- Avoid using while bathing. If continuous usage is required by the physician's prescription, the concentrator must be located in another room at least 7 ft (2.5 m) from the bath.
- DO NOT come in contact with the concentrator while wet.
- DO NOT place or store concentrator where it can drop into water or other liquid.
- DO NOT reach for concentrator that has fallen into water. Unplug IMMEDIATELY.
- DO NOT block access to power outlet needed to unplug the AC power cord.
- DO NOT use frayed or damaged power cords.
- DO NOT use AC power adapter if its housing is cracked or separated.



WARNING!

Risk of Injury or Death

To prevent injury or death from product misuse:

- Closely supervise when this concentrator is used by impaired individuals or near children and/or impaired individuals.
- Monitor patients using this device who are unable to hear or see alarms or communicate discomfort.



CAUTION!

Risk of Minor Injury or Discomfort

While Invacare strives to produce the best oxygen concentrator in the market today, this oxygen concentrator can fail to produce oxygen due to power failure or device malfunction.

- ALWAYS have a backup source of oxygen readily available.
- In the event the concentrator fails to produce oxygen, the concentrator will briefly alarm signaling the patient to switch to their backup source of oxygen. Refer to Troubleshooting for more detail.
- Invacare recommends keeping at least one battery installed in the concentrator even when operating from an external power source.



WARNING!

Risk of Death, Injury or Damage

To prevent injury or damage from cord misuse:

- DO NOT move or relocate concentrator by pulling on the cord.
- DO NOT use extension cords with AC power adapters provided.
- Properly store and position electrical cords and/or tubing to prevent a tripping and strangulation hazards.



WARNING!

Risk of Injury or Damage

To prevent injury or damage during use:

- If you feel ill or uncomfortable, or if the concentrator does not signal an oxygen pulse and you are unable to hear and/or feel the oxygen pulse, consult your equipment provider and/or your physician IMMEDIATELY.
- For optimum performance, Invacare recommends that each use of the concentrator be a minimum of 30 minutes. Shorter periods of operation may reduce maximum product life.
- The concentrator should be used in an upright position.
- The concentrator cannot be used in conjunction with PAP, Bi-Level, mechanical ventilator or other such devices.

**CAUTION!****Risk of Minor Injury, Discomfort or Damage**

- Use of this device at an altitude above 10,000 ft (3048 m) or outside a temperature of 41°F to 104°F (5°C to 40°C) or a relative humidity above 90% is expected to adversely effect the flowrate and the percentage of oxygen and consequently the quality of therapy.

**WARNING!****Risk of Injury or Damage**

- As a safety feature, this appliance may have a polarized plug (one blade is wider than the other). To avoid injury or damage from electrical shock:
- This plug will fit in a polarized outlet only one way. If the plug does not fit fully in the outlet, reverse the plug. If it still does not fit, contact a qualified electrician.
 - DO NOT alter the plug in any way.
 - DO NOT use if the cord or plug are damaged. Call a qualified electrician for repair.

**CAUTION!****Risk of Damage**

- To prevent damage from temperature variations:
- DO NOT operate in temperatures below 41°F (5°C) or above 104°F (40°C).
 - When your automobile is turned off, disconnect the car accessory power cord and remove the concentrator from the automobile. DO NOT store the concentrator in a very hot or cold automobile or in other similar, high or low, temperature environments. Refer to Specifications in Technical Data.

**WARNING!****Risk of Injury or Damage**

- To prevent damage from liquid ingress:
- If the concentrator is not working properly, if it has been dropped or damaged, or dropped into water, call equipment provider/qualified technician for examination and repair.
 - NEVER drop or insert any object or liquid into any opening.
 - Invacare recommends the concentrator not be used in the rain.
 - The concentrator is not designed to be used with a humidifier. Use of this device with a humidifier may impair performance and/or damage the equipment.
 - DO NOT use if cabinet of concentrator or housing of AC power adapter is cracked or separated.

2.3 Radio Frequency Interference

Medical Electrical Equipment needs to be installed and used according to the EMC information in this manual.

This equipment has been tested and found to comply with EMC limits specified by IEC/EN 60601-1-2. These limits are designed to provide a reasonable protection against electromagnetic interference in a typical home health care environment.

Portable and mobile RF communications equipment can affect the operation of this equipment. Use of this equipment adjacent to or stacked with other equipment should be avoided as it could result in improper operation. The concentrator operation should be observed to verify normal operation in the presence of such equipment.

Other devices may experience interference from even the low levels of electromagnetic emissions permitted by the above standards. To determine if the emissions from the concentrator are causing the interference, turn the concentrator off. If the interference with the other device(s) stops, then the concentrator is causing the interference. In such rare cases, interference may be reduced or corrected by one of the following measures:

- Reposition, relocate, or increase the separation between the equipment.
- Connect the equipment into an outlet on a circuit different from that to which the other device(s) is connected.

Refer to Electromagnetic Compliance (EMC) in Technical Data for additional information.

2.4 Traveling with the Concentrator

Before Traveling

1. Contact your travel carrier and/or tour guide about your travel plans and provide information about your intent to use a portable oxygen concentrator during your travels. The carrier will let you know if you will be permitted to use your concentrator during your travel and if there are any restrictions for use.



If you are not permitted to use your concentrator on the carrier of choice and still want to take it with you:

- Carry it and any supplemental batteries on board with you.
 - Ensure the unit is turned off.
 - Stow it properly for the trip.
 - DO NOT place the concentrator or any supplemental batteries in checked baggage.
2. Contact the carrier to see if they have seats with a power outlet that you can use to power the concentrator during travel. If a power outlet is not available, be sure to bring enough supplemental batteries to last 150% of the travel time.



There may be unexpected delays beyond scheduled travel times. Carry your power adapters with you so you can recharge batteries before and after the trip.

3. Charge the installed battery of the concentrator and any supplemental batteries fully before you depart, thus extending the operating time of the concentrator during travel. Refer to Charging the Battery(s) in Setup.
4. Ensure the unit is free of all grease, oil, or other petroleum products and that the unit is in good working order, is free of damage, and the air filter is clean. Refer to the Preventative Maintenance Checklist in Maintenance.
5. Contact your oxygen supplier to make arrangements if you need to have backup oxygen at your destination.

Traveling By Air

Arriving at the Airport

1. Allow the security agent to inspect your concentrator, even if you are using it, when going through the security checkpoint.

 They are required to allow you to travel through the checkpoint with your concentrator, but they MUST inspect it for security reasons.

2. Use your AC power adapter while you are in the airport, if possible. This will keep the battery(s) at full charge and give you the most battery powered operating time on the aircraft.

Boarding the Plane

 You are not permitted to sit in an exit row if you plan to use your concentrator at any time during the flight.

1. If you plan on using the concentrator the entire time you are on the plane, verify that your concentrator does not block access to an emergency exit or aisle way. If it does, request a seat change.
2. In order for the flight crew to ensure the safety of you and all of the other passengers on the flight, allow them to inspect the concentrator to confirm that it is FAA approved for use on the flight.
3. If you are not planning to use your concentrator during taxi, takeoff, or landing, you MUST store it in an approved storage area so it does not block the row or aisle access.

 Contact the flight crew about location of approved storage areas.

On the Plane

 You MUST store the supplemental battery either securely connected to the concentrator or in your carry-on baggage. The supplemental battery MUST be protected from damage and shorting out the external power connector.

1. You may use your concentrator when moving about the cabin, **ONLY** after the pilot turns off the “Fasten Seat Belt” sign.
2. Turn off the unit if the concentrator alarms during the flight, unless the alarm resets itself. If the alarm does not reset, the concentrator **MUST** be turned off and stored in an approved storage area.
3. If an AC power outlet with a minimum 100W capacity is available on the flight, perform the following:
 - a. Connect the power adapter to the concentrator.
 - b. Plug in the power adapter into the airline power outlet.
 - c. Turn the unit on.



If you have any trouble making the connections to the plane’s power outlet, contact the flight crew for assistance.

After the Flight

1. Ensure you have enough power to run your concentrator while leaving the airport. Recharge the battery(s), if necessary. Refer to Charging the Battery(s) in Setup.
2. Contact your medical gas supplier to obtain your backup oxygen supply, if necessary.

Traveling by Boat

Contact the cruise line and inform them you are traveling with a concentrator. There should be no restrictions on your use of the concentrator during your travel, but it is wise to check with them ahead of time. Power should be available for use of your AC power adapter during your travels, but check first.

Traveling by Train

Contact the train authorities at least twelve hours ahead of arrival that you are going to use your concentrator. There should be no restrictions on your use of the concentrator, but power on the train may not be available for your use during travel times. Ensure there is enough battery life for your trip before you leave.

Traveling by Bus

Contact the bus line about using a concentrator. There should be no restrictions on your use of the concentrator during your trip, but power may not be available for your use during travel times. Ensure there is enough battery life for your trip before you leave.

Traveling by Car

There should be no restrictions on your use of the concentrator during your trip, but power may not be available for your use during travel times. Ensure there is enough battery life for your trip before you leave.

3 Setup

3.1 Unpacking

1. Check for any obvious damage to the carton or its contents. If damage is evident, notify the carrier or your local dealer.
2. Remove all loose packing from the carton.
3. Carefully remove all the components from the cartons. The Invacare concentrator's packaging contains the following items (as shown below) in addition to this user manual. If any parts are missing, please contact your equipment provider.
 - Concentrator (Model POC1–100B) with carry bag (Model POC1–150) installed
 - Cannula (Westmed #0194)
 - Two shoulder straps (Part Number 1187483)
 - Battery (Model POC1–110)
 - AC power adapter (Part Number 1187452)
 - AC power cord (Part Number 1187454 for model POC1–100B)
 - DC power cable (Model POC1–140)



Retain all containers and packing materials for storage or return shipment.

3.2 Inspection

Inspect/examine exterior of the oxygen concentrator and accessories for damage. Inspect all components. If damage is found, DO NOT use concentrator. Contact your provider for service and/or repair or for assistance with the setup procedure and to report unexpected operation or events.

3.3 Powering the Oxygen Concentrator



WARNING!

Risk of Injury or Damage

To avoid injury and damage that will void the warranty:

- Use only Invacare specified power supplies with the oxygen concentrator.
- Prior to using the DC power cable, the automobile (boat, motor home, etc.) engine should be running in order to either operate or charge the oxygen concentrator.



IMPORTANT

The concentrator will not turn on unless the battery is charged.

- Connect AC power to the concentrator and allow battery to fully charge prior to first use.

The oxygen concentrator allows the freedom to choose from the following power sources to enable use both inside and outside of the home:

- Rechargeable battery(s)
- AC power outlet
- 12 volt DC power cable

3.3.1 Installing the Battery(s)



DANGER!

Risk of Death, Injury or Damage

To avoid death, injury or damage from fire:

- DO NOT heat above 140°F (60°C), incinerate, disassemble, or short terminals.
- Dispose in accordance with all local regulations.

The oxygen concentrator comes equipped with a single rechargeable lithium battery. Up to two batteries can be installed in the concentrator. When fully charged, a single battery supplies power for up to five hours, depending on the pulse flow setting. Two batteries can supply power for up to ten hours when fully charged, depending on the pulse flow setting.

A battery can be installed while the concentrator is operating from an external power source or a second charged battery.

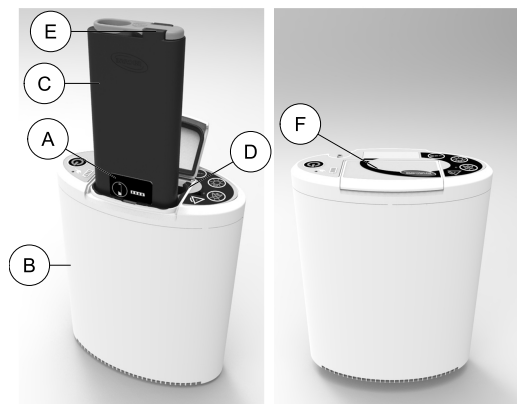

1. Open the battery compartment door (F).
2. With battery fuel gauge label (A) facing toward the front of the oxygen concentrator (B), slowly lower battery (C) straight down into one of the two slots in the battery compartment (D).



Use the lift ring (E) to hold the battery while installing it.

The battery will not fit properly in the battery compartment if not oriented as described above.

3. Ensure the battery fully engages the battery connections located at the bottom of the battery compartment. When fully inserted, the top of the battery is level with the top edge of the battery compartment.



CAUTION!
Risk of Damage

To avoid damage to battery connections from excessive force or misuse:

- DO NOT slam or force battery(s) into place.
- Orient the battery(s) as described in the instructions prior to installing.

To avoid damage to the battery door from excessive force or misuse:

- DO NOT lift concentrator using the battery door.
- Make sure battery(s) are fully installed before closing this battery door.
- DO NOT use concentrator with battery door open.

4. If a second battery is being used (sold separately), install it in the same manner in the unoccupied battery slot.
5. Close the battery compartment door (E).

3.3.2 Charging the Battery(s)

Initial Charging of the Battery(s)

Using the concentrator for the first time requires the battery(s) to be charged. Batteries are shipped in a “sleep” mode and an initial charge cycle is required to “wake”

up the batteries. To charge the battery(s), perform the following steps:

1. Install the battery. Refer to Installing the Battery(s) in Setup.
2. Connect AC power to the concentrator. Refer to External AC Power in Setup.
3. Monitor the battery charge level and charge until full. Refer to Battery Gauge for Installed and Uninstalled Battery(s) in Setup.
4. Disconnect the AC power adapter from the concentrator for portable operation.



IMPORTANT

A concentrator will not turn on unless the battery is charged.

- Connect the AC power to the concentrator and allow battery to fully charge prior to first use.
- Refer to Specifications in Technical Data for approximate charge times.

Charging the Battery(s) After Initial Charging



The installed battery(s) can be charged whether the concentrator is on or off.

1. For charging of the battery(s) after initial charging, do one of the following:
 - Connect the AC power adapter (if charging from a wall outlet). Refer to External AC Power in Setup.
 - Connect the DC power cable (if charging from a vehicle). Refer to External DC Power in Setup.
 - Remove battery and charge with the optional External Battery Charger accessory, Model POC1–115.
2. Monitor the battery charge level and charge until full. Refer to Battery Gauge for Installed and Uninstalled Battery(s) in Setup.
3. Disconnect external power from the concentrator for portable operation.

3.3.3 Reading the Battery Gauge for Installed and Uninstalled Battery(s)

Battery Gauge for Installed Battery(s)

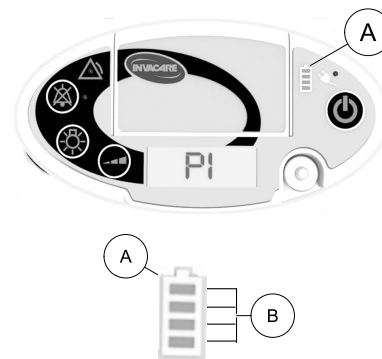

The battery gauge ① shows the status of the installed battery charge level when the concentrator is turned on and when the concentrator is off but connected to an external power source. The number of illuminated segments ② of the battery gauge ① indicates the charge level of the installed battery. If two batteries are installed the indicated charge level is that of the least charged battery.

Number of Lit Segments ②	Charge Level
1	0–25% charge
2	26–50% charge
3	51–75% charge
4	76%-100% charge

When the concentrator is connected to an external power source (whether the concentrator is turned on or off) the “last” or “highest” segment ② of the battery gauge ① also

flashes to show the battery is charging. When the battery is fully charged, the fourth segment **B** of the battery gauge **A** stops flashing and remains lit.

Battery Gauge for Uninstalled Battery(s)

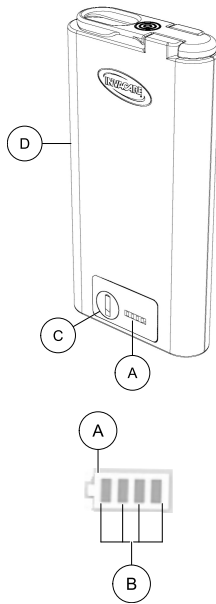

When the battery **D** is removed from the concentrator, press the battery status button **C** to show the status of the charge level on the battery gauge **A**. Refer to the charge level **B** table in Reading the Battery Gauge for Installed and Uninstalled Battery(s) in Setup.

1194969-C

3.3.4 Removing the Battery(s)

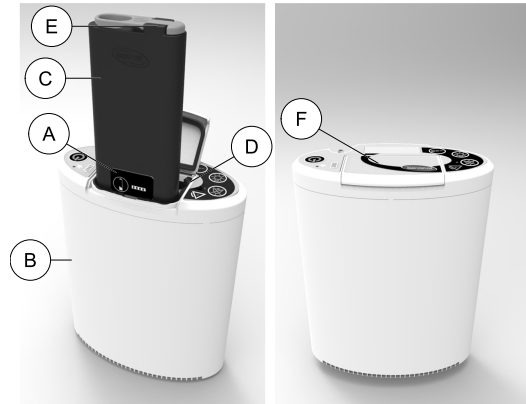

1. Open the battery compartment door **F** of the concentrator **B**.
2. Pull straight up on the lift ring **E** to remove the battery **C** from the battery compartment **D**.
3. If a second battery is being used (sold separately), remove it in the same manner.
4. Close the battery compartment door.



A steady audible beep will occur when all power sources are removed from the concentrator. Refer to Shut Down Alarms in Troubleshooting.

A battery can be removed without affecting the operation of the concentrator as long as an external power source or a second charged battery is installed.

3.3.5 External AC Power

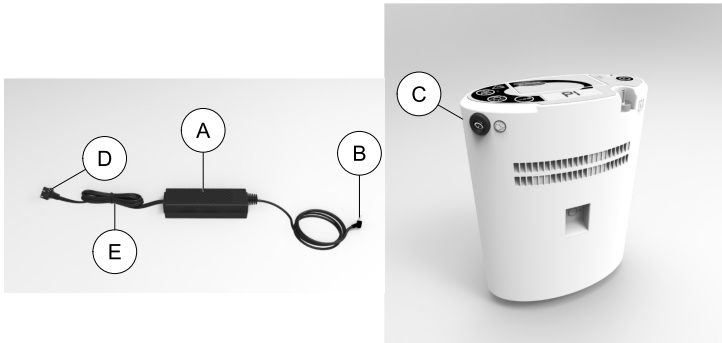

The AC power adapter (A) allows the oxygen concentrator to be connected to a 100–240 volt 50–60 Hertz outlet (i.e. wall outlet of your home). The power adapter converts AC voltage to a DC voltage that can be used to power the oxygen concentrator. Use of the AC power adapter will allow the oxygen concentrator to operate and simultaneously recharge the battery(s).

Complete the following steps to connect the AC power adapter to the concentrator:

1. If not already assembled, attach the AC power cord (E) to the AC power adapter (A).
2. Insert the AC power adapter outlet connector (B) into the external power input connector (C) of the concentrator.
3. Insert plug (D) into an AC outlet.



The external power input connector of the concentrator is angled slightly upward. The outlet connector of the power cord needs to be angled slightly upward when installed.

When a battery is installed, external AC or DC power can be connected or disconnected whether the concentrator is off or on.

When an external power source is properly connected to the concentrator, the orange indicator light next to the plug symbol on the control panel will illuminate and there will be an audible beep. When external power is disconnected, the orange light will turn off and there will be an audible beep.

3.3.6 External DC Power

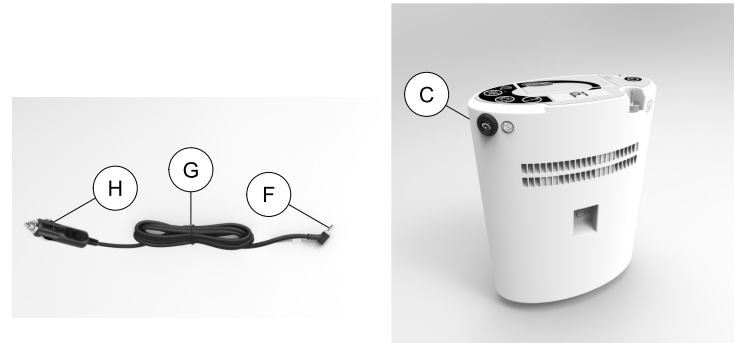

The DC power cable (G) allows the oxygen concentrator to be connected to an automobile's (boat, motor home, etc.) 12-volt DC outlet. Use of the DC power cable will allow

the oxygen concentrator to be operated and simultaneously recharge the battery.

Complete the following steps to connect the DC power cable to the concentrator:

1. Insert the DC power cable outlet connector **F** into the external power input connector **C** of the concentrator.
2. Insert plug **H** into a DC outlet after the automobile (boat, motor home, etc.) is running.

3.4 Carry Bag Setup



CAUTION! Risk of Damage

- Improper installation of the concentrator into the carry bag can cause a high temperature alarm condition and result in the concentrator shutting down.
- The carry bag is not designed to protect the concentrator from excessive drops, impacts, or abuse.
- To install or remove the carry bag the concentrator must be off and disconnected from external power and cannula.



Concentrator can be operated with or without the carry bag. When out of the carry bag, the concentrator is limited to stationary use. Refer to Using the Carry Bag in Usage.

3.4.1 Installing the Carry Bag

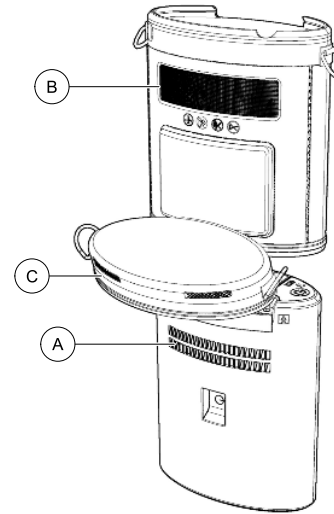

1. Fully unzip the base of the carry bag.
2. Position the concentrator standing upright on a flat surface and oriented with air intake opening **A** facing you. Ensure the concentrator is off and disconnected from external power and cannula.
3. Position the carry bag above the concentrator with the air intake filter screen **B** facing you.
4. Hold the unzipped bottom of the carry bag open **C**, and slide the carry bag down onto the concentrator until the carry bag completely covers the concentrator.

5. Lay the concentrator and carry bag down with air intake filter screen facing upward.
6. Push the concentrator into the carry bag until it is fully seated against the top retainer.
7. Rotate the base of the carry bag onto the bottom of the concentrator and fully zip up the bottom of the carry bag.
8. Return the concentrator and carry bag to the upright position.
9. Check that the cutouts in the top retainer are correctly aligned with the oxygen outlet port and external power input connector. If not aligned, remove the carry bag and reinstall as described in steps 1–9.

3.4.2 Removing the Carry Bag

1. Ensure the concentrator is off and disconnected from external power and cannula.
2. Lay the concentrator on a flat surface with the air intake filter screen facing upward and fully unzip the base.
3. Rotate the base of the carry bag off the bottom of the concentrator.
4. From the bottom, pull the concentrator out of the carry bag. If needed, the top surface of the concentrator can be pushed to help remove it from the bottom of the carry bag.
5. Return the concentrator to the upright position.
6. Fully zip up the bottom of the carry bag.

3.4.3 Installing Shoulder Straps



The carry bag can be configured as a messenger bag using one shoulder strap or as a back pack using two shoulder straps.



Messenger Bag Configuration

1. Using a single shoulder strap (A), attach a clip (B) from each end of the strap to rings (C) at the top of the carry bag (D).
2. Adjust shoulder strap to desired length.
3. Slide pad (E) on shoulder strap to the desired location.

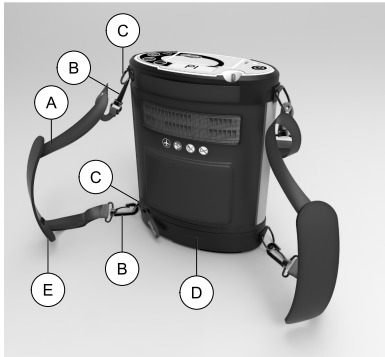

Back Pack Configuration

1. Attach each clip **B** at the ends of a single shoulder strap **A** to the two rings **C** located at the top and bottom of the carry bag **D**.
2. Repeat for the second strap on the opposite side.
3. Adjust each shoulder strap to desired length.
4. Slide pad **E** on each shoulder strap to the desired location.

3.5 Connecting/Positioning the Nasal Cannula



DANGER!

Risk of Injury or Death

The cannula can cause tripping, falling, or other injury if improperly positioned and secured. To avoid injury or death:

- The cannula **MUST** be routed and secured properly.
- **DO NOT** position the cannula around the neck. Ensure the patient can move freely while wearing the cannula.
- Avoid positioning cannulas across areas of high foot traffic (i.e. aisles, doorways, hallways, etc.)



WARNING!

Risk of Injury or Death

To avoid choking and/or strangulation from tubing entanglement:

- Keep children and pets away from nasal cannula and tubing.
- Close supervision is necessary when the nasal cannula is used by impaired individuals or near children and/or impaired individuals.



WARNING!

Risk of Injury or Death

To reduce the risk of injury or death from illness:

- Replace the nasal cannula on a regular basis. Check with your equipment provider or physician to determine how often the cannula should be replaced.
- DO NOT share cannulas between patients. Cannulas are for single patient use only.



CAUTION!

Risk of Damage

- Use of sterilization or cleaning solutions may leave this device nonfunctional.



CAUTION!

Risk of Minor Injury or Discomfort

To ensure proper breath detection and oxygen delivery:

- Ensure the cannula prongs are positioned properly in your nose. This is critical to the effectiveness of the oxygen therapy.
- DO NOT use tubing/cannula length exceeding 25 ft (7,6 m).
- Use crush-proof oxygen tubing.
- Use ONLY single lumen cannulas with the flow characteristics stated in Specifications in Technical Data.
- Avoid use of concentrator in windy conditions.
- Check for gas flow at the outlet of the cannula.

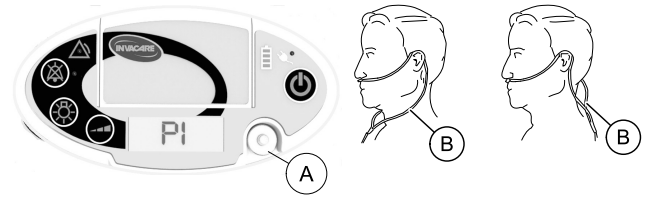

1. Remove the cannula from its packaging.
2. Connect the cannula to the concentrator oxygen outlet port **A**. Ensure the connection is secure.
3. Place the cannula **B** over your ears and position the prongs in your nose as instructed by your health care provider or cannula manufacturer.



Gas flow at the outlet of the cannula can be checked while the concentrator is warming up. Wave your hand in front of the nasal prongs. You should be able to hear and feel the pulsed flow of gas. If you do not feel the gas pulse, check the cannula connection for leaks.

4 Usage

4.1 Location

The concentrator can be used in a home, institution, vehicle or other environments outside the home.



WARNING!

Risk of Injury or Damage

To avoid injury or damage from airborne pollutants and/or fumes and for optimal performance:

- Locate and position the concentrator in a well ventilated space so that the air intake and the air exhaust openings are not obstructed.
- NEVER block the air openings of the concentrator or place it on a soft surface, such as a bed or couch, where the air opening may be blocked.
- Keep the openings free from lint, hair and similar foreign items.
- Keep concentrator at least 12 in (30.5 cm) away from walls, draperies and furniture.
- DO NOT use in presence of pollutants, smoke or fumes, flammable anesthetics, cleaning agents or chemical vapors.



Refer to Using the Carry Bag in Usage for detail on the location of the air intake and exhaust openings.

4.2 Concentrator Operating Position

When not being worn, the concentrator should be operated in the upright position and placed on a firm, level surface.



The concentrator should be in a location where the audible signal can be heard.

4.3 Using the Carry Bag



WARNING!

Risk of Injury or Damage

To avoid injury or damage from dropping the concentrator or incorrect positioning of the concentrator:

- The carry bag must be used for portable operation of the concentrator.
- DO NOT adjust the shoulder strap while carrying the concentrator.
- Position concentrator so exhaust vents are directed away from the body and control panel faces upward.
- Use only Invacare carry bag, model POC1–150.



CAUTION!

Risk of Minor Injury or Discomfort

To avoid injury from concentrator malfunctioning:

- Ensure you are able to hear the audible signal warnings when using the carry bag as a backpack in case an alarm condition occurs.

The carry bag can be configured as a messenger bag using one shoulder strap or as a backpack using two shoulder straps. The length of the shoulder strap(s) can be adjusted

to the desired position. Refer to Installing Shoulder Straps in Setup.



Messenger Bag Configuration



Backpack Configuration

When carrying the concentrator with the shoulder strap(s) (A), position the concentrator with the control panel facing upward and the air intake (C) opening towards the body. This orients the concentrator so that the exhaust vent (B)

is directed away from the body and the control panel is positioned for proper viewing.

The carry bag also has a handle (D) that can be used to move and position the concentrator.

4.4 Turning On the Concentrator



1. To turn on the concentrator press the On/Off button (A) until you see the control panel indicators light up.
2. The audible signal will beep and all the indicators will light up for approximately two seconds after the unit is first turned on. This power up sequence provides the opportunity to ensure that all indicators are functioning properly.
3. Following the power up sequence a warm up period begins. For more details, refer to Warm Up Period in Usage.

4.5 Turning Off the Concentrator

1. To turn off the concentrator press the On/Off button until “Powering Down” is shown on the display screen.
2. The power down sequence takes a approximately three seconds.

4.6 Warm Up Period



CAUTION!

Risk of Minor Injury or Discomfort

During the warm up period (typically less than five minutes) oxygen output is not within specifications listed in Specifications in Technical Data.

- Concentrator may be used during warm up period.

After turning on the concentrator a warm up period of up to 15 minutes is needed to reach the specified oxygen purity. “Warming Up” is shown on the display screen during this period.

While warming up, the concentrator will automatically deliver a pulse of oxygen about every four seconds when no breath is detected. The nasal cannula should be connected to the concentrator during warm up period.

When the concentrator has finished warming up, the current pulse setting will be shown on the display screen. If no breath is detected after warm up has ended, the No Breath Detected alarm will occur. Refer to Alarm Conditions in Troubleshooting.

4.7 Breathing with the Use of the Concentrator

As you breathe with the nasal cannula installed, a pulse of oxygen is delivered each time the concentrator senses an inhalation. Refer to Connecting/Positioning the Nasal Cannula in Setup for cannula installation instructions.

If no breath is detected for 15 seconds, the No Breath Detected alarm will occur. Refer to Alarm Conditions in Troubleshooting.

4.8 Reading the Display Screen

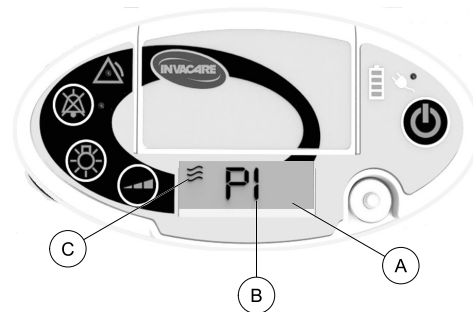

Pulse Flow Setting and Pulse Icon

After the concentrator finishes warming up, the current oxygen pulse flow setting **Ⓑ** and pulse icon **Ⓒ** are shown on the display screen **Ⓐ**.

The pulse icon flashes on each time an oxygen pulse is triggered.



The pulse flow setting and pulse icon are not shown when alarm text is displayed on screen.

Informational Text

Informational text is shown on the display screen during certain periods of concentrator operation:

- “Warming Up” — displayed while the concentrator is warming up after first being turned on.
- “Powering Down” — displayed while the concentrator is powering down after being turned off.

Alarm Text

If an alarm condition exists, text describing the alarm will be shown on the display screen.

Refer to Alarm Conditions in Troubleshooting for more detail on alarm conditions and related alarm text.

4.9 Adjusting the Pulse Flow Setting



CAUTION!

Risk of Minor Injury or Discomfort

It is very important to select the prescribed oxygen flow setting. This will ensure you will receive the therapeutic amount of oxygen according to your medical condition:

- DO NOT increase or decrease the flow setting unless a change has been prescribed by your physician or therapist.
- The therapeutic effectiveness of the prescribed oxygen flow setting should be periodically reassessed.
- Use only the length of cannula that was used to determine the prescribed oxygen flow setting.
- The pulse flow settings of this concentrator might not correspond to continuous flow oxygen.
- The settings of other models or brands of oxygen therapy equipment do not correspond to the settings of this concentrator.

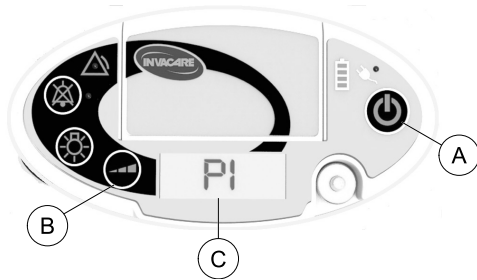

1. With the concentrator running, press the flow selection button **B** to increase the pulse flow setting by one increment.
2. Press the flow selection button additional times, as needed, until your prescribed flow setting (P1 to P4/P5) is shown on the display screen **C**.



Each time the flow setting is changed, an audible beep will occur and the display screen backlight will turn on for five seconds.

- POC1-100B Models: The concentrator has four pulse flow settings. When the maximum pulse flow setting P4 is reached, the pulse flow setting returns to setting P1 with the next button press.
- POC1-100C Models: The concentrator has five pulse flow settings. When the maximum pulse flow setting P5 is reached, the pulse flow setting returns to setting P1 with the next button press.



If a message other than the pulse flow setting is shown on the display screen, the adjusted pulse flow setting will temporarily be displayed for five seconds after pressing the flow selection button.



The concentrator pulse flow setting at power-up will be the same flow setting selected the last time the unit was turned off.

4.10 Battery Life and Management

Time away from home is greatly extended by combining the use of the AC power adapter, DC power cable and the concentrator's batteries. To ensure the battery(s) maintain their optimal charge level, utilize the AC power adapter whenever you have access to electric power. Utilize the DC power cable whenever you are in a vehicle.



CAUTION!

Risk of Minor Injury or Discomfort

Battery exhaustion will result in a loss of supplemental oxygen. To ensure proper supplemental oxygen delivery during a power outage:

- Plug your portable concentrator into an alternate power source.
- Have an alternate source of oxygen available that does not require a power source.

What to Do

- When you first receive your concentrator, fully charge the battery(s) overnight.

- Keep your battery(s) fully charged when using the concentrator on a daily basis.
- Your concentrator battery(s) can be recharged at any time.
- Always ensure the concentrator battery(s) are recharged as soon as possible after they become fully discharged. The battery(s) may be permanently degraded if left fully discharged for an extended length of time.
- Check the status of your concentrator battery(s) once a month if you are not using your concentrator on a daily basis. Battery(s) should be maintained at two illuminated bars worth of charge if not using the concentrator on a daily basis.
- Heat is the worst enemy of a battery. Allow plenty of air to circulate around the concentrator so that the battery(s) is kept as cool as possible when in use and when charging.
- DO NOT leave your battery(s) installed into the concentrator when the concentrator is not going to be used for more than a day. The battery(s) will lose charge while plugged into the concentrator even with the concentrator turned off.

What Not to Do

- DO NOT use or leave the concentrator or battery(s) in excessive heat or cold.
- DO NOT store or leave the concentrator or battery(s) in car trunks, etc. for extended periods of time.
- DO NOT store battery(s) fully charged (four bars illuminated on the unit's battery gauge) if you are going to store your concentrator for any time greater than a day. Recharge or discharge the battery to two bars (50% charge) only. Storing a battery with a full charge may degrade its useful life.

5 Maintenance

5.1 Maintenance



WARNING!

Risk of Injury or Damage

Invacare oxygen concentrators are specifically designed to minimize routine preventive maintenance. To prevent injury or damage:

- Only professionals of the health care field or persons fully conversant with this process such as factory trained personnel should perform preventive maintenance or performance adjustments on the oxygen concentrator and its equipment, except for tasks described in this manual.
- Users should contact your dealer or Invacare for service.

5.2 Service Life

The expected service life of this product, with the exception of wear components (see *6.3 Wear and Tear, page 48*), is three years of operation when used in accordance with the safety instructions, maintenance intervals and correct use stated in this manual. The effective service life can vary according to the frequency and intensity of use. Refer to the procedures in *5 Maintenance, page 41*.

Perform all maintenance according to the recommended schedule in this manual.

5.3 Cleaning the Cabinet



DANGER!

Risk of Injury or Damage

Liquid will damage the internal components of the concentrator and its equipment. To avoid damage or injury from electrical shock:

- Turn Off the concentrator and unplug the power cord before cleaning.
- DO NOT allow any cleaning agent to drip inside the air inlet and outlet openings.
- DO NOT spray or apply any cleaning agent directly to the cabinet.
- DO NOT hose down the product.



CAUTION!

Risk of Damage

Harsh chemical agents can damage the concentrator and its equipment. To avoid damage:

- DO NOT clean with alcohol and alcohol based products (isopropyl alcohol), concentrated chlorine-based products (ethylene chloride), and oil-based products (Pine-Sol®, Lestoil®) or any other harsh chemical agents. Only use mild liquid dish detergent (such as Dawn®).

Periodically clean the concentrator's cabinet as follows:

1. Turn off concentrator.
2. Remove the concentrator from the carry bag or back pack.
3. Use a damp cloth, or sponge, with a mild detergent such as Dawn dish washing soap to gently clean the exterior case.
4. Allow the concentrator to air dry, or use a dry towel, before returning the concentrator to the carry bag or back , and prior to operating the concentrator.
5. Return the concentrator to its carry bag or back pack.

 The AC power adapter and AC power cord are to be cleaned in a similar manner.

5.4 Cleaning the Air Intake Filter Screen



CAUTION! **Risk of Damage**

To avoid damage from clogging:
– Replace the carry bag if the air intake filter screen is torn or frayed.

 Clean the air intake filter screen at least once each week. The air intake filter screen is part of the carry bag.



1. Turn off concentrator.
2. Use a vacuum cleaner or nylon brush to clean dust/debris from air intake filter screen (A).

5.5 Cleaning the Carry Bag



CAUTION! **Risk of Damage**

To avoid damage to the product:
– DO NOT machine wash or dry the carry bag.



1. Turn off concentrator.
2. Remove the concentrator (A) from the carry bag (B).
3. Connect concentrator to an external power source.

4. Wipe or brush the carry bag with a mild liquid dish detergent (such as Dawn) and water. Rinse thoroughly.
5. Allow the carry bag to air dry after cleaning and before using.

5.6 Cleaning and Disinfection Between Patients

Cleaning and disinfection must be performed between patients and as necessary.



WARNING!

Risk of Injury or Damage

To prevent injury from infection or damage to concentrator:

- Only qualified personnel should perform cleaning and disinfection of the oxygen concentrator and accessories between patients.



Follow these instructions to eliminate possible pathogen exchange between patients due to contamination of components or accessories.

1. Dispose of and replace all patient side accessories not suitable for multiple patient use, including but not limited to: cannula and oxygen tubing.
2. Clean concentrator and accessories as described in Maintenance.

3. Disinfect the surfaces of the concentrator and accessories using Clorox® 4 in One Disinfectant & Sanitizer or substantially equivalent product.



WARNING!

Risk of Injury or Damage

- Follow the cleaning/disinfectant product manufacturer's instructions for use, handling, storage and disposal of the product.
- Use of inappropriate disinfecting products may degrade device materials and negatively affect device safety and performance.



If the accessories, such as the carry bag, are unable to be cleaned or disinfected, discard the accessory and replace.

4. Perform the tasks on Preventive Maintenance Checklist.
5. Before repackaging and distribution to new patient, ensure packaging contents contain the concentrator, battery, carry bag with shoulder straps, AC power adapter, AC power cord, DC power cable, labels and user manual.

5.7 Viewing Hour Meter

To view the elapsed hours of concentrator run time perform the following steps:

1. Ensure that the unit is powered off and connected to an external power source.
2. Press and hold the flow selection button for five seconds.



3. The cumulative hours of concentrator operation (compressor hours) will be shown on the display screen for as long as the button is continually pressed. The concentrator run time is displayed to the nearest 0.1 hours.
4. Release the flow selection button.

5.8 Preventative Maintenance Checklist

The following Preventative Maintenance Checklist contains maintenance tasks to be performed by the users of this product, except where otherwise noted. If you are unable to understand these tasks, contact your provider or a qualified technician.

REF

SN

WEEKLY							
Record Date of Service.							
Record Elapsed Hours on Hour Meter. (Refer to Viewing Hour Meter in Maintenance.)							
Clean Air Intake Filter Screen							
Inspect Cabinet of Concentrator and AC Adapter for Damage. Do not use if damage is found. Return to Invacare for repair.							
Inspect Carry Bag Strap(s) and hardware for Damage. Replace strap or carry bag if damage found.							
Inspect Electrical Cords for Damage. Replace Electrical Cord if damage is found.							
Check for presence and legibility of all Labels. Replace Labels as needed. Refer to Label Locations.							

REF

SN

EVERY 4,380 HOURS, EVERY 3 YEARS, AND BETWEEN PATIENTS, WHICHEVER COMES FIRST							
Check Oxygen Purity*							
Perform Functional Test*							
DURING PREVENTATIVE MAINTENANCE SCHEDULE AND BETWEEN PATIENTS							
Check Intake Filter Screen for damage. Replace carry bag if damage is found.							
Check/Replace Outlet Filter*							

Inspection periods shown as hours is in reference to hours of concentrator operation since the last date of service. Refer to Viewing Hour Meter in Maintenance. Inspection periods shown as months or years is in reference to duration of time since the last date of service.

*To be conducted by provider or qualified technician. Refer to service manual.

6 After Use

6.1 Storage

1. Remove battery(s) prior to storage.
2. Store the repackaged oxygen concentrator and battery(s) in a cool, dry area.
3. DO NOT place objects on top of packaged concentrator.

 Refer to storage conditions in Specifications in Technical Data.

 After removing from storage, it may take up to one hour at room temperature for the product to reach its operating temperature and be ready for use.

6.2 Disposal

Recycle



DO NOT dispose of in household waste



This product has been supplied from an environmentally aware manufacturer who complies with the Waste Electrical and Electronic Equipment (WEEE) Directive 2012/19/EC. This product may contain substances that could be harmful to the environment if disposed of in places (landfills) that are not appropriate according to legislation.

Follow local governing ordinances and recycling plans regarding disposal of the concentrator or components normally used in operation. The concentrator does not generate waste or residue in operation.

- DO NOT dispose of the concentrator in the normal waste stream.
- Any accessories not part of the concentrator MUST be handled in accordance with the individual product marking for disposal.
- DO NOT dispose of the internal or supplemental batteries. Batteries should be returned to your dealer/provider.

6.3 Wear and Tear

Invacare reserves the right to ask for any item back that has an alleged defect in workmanship. See Warranty that shipped with the product for specific warranty information.

Refer to Maintenance in this manual for proper preventative maintenance schedule and use of the product.

This is only a general guideline and does not include items damaged due to abuse and misuse.

Normal wear and tear items and components for this product are listed below.

Description	Expected Life
Compressor inlet filter	1,460 hours
Carry bag	18 months
Battery	18 months
Sieve bed assembly	1 year



Expected life values shown as hours is in reference to hours of concentrator operation. Refer to Viewing Hour Meter in Maintenance. Expected life values shown as months or years is in reference to duration of time since the date of purchase.



Sieve is a porous filtering material and is considered a wear item. Some factors that could affect sieve material life include humidity, temperature, particulates, air contaminates, air intake, vibration and other environmental conditions.

7 Troubleshooting

7.1 Troubleshooting

If your concentrator fails to operate properly, refer to the following chart for possible causes and solutions. If necessary, contact your provider.

Oxygen Concentrator Does Not Turn On or Does Not Stay On

Symptom	Probable Cause	Solution(s)
Concentrator does not operate when On/Off button is pressed. OR Concentrator begins to operate when On/Off button is pressed, but all LCD and front panel lights go dark.	On/Off button was not held down long enough.	Try to power up the concentrator again while continuing to press the On/Off button until the front panel lights and LCD begin to illuminate. This takes typically one full second.
	Battery is discharged (or improperly connected to the concentrator).	<ol style="list-style-type: none"> 1. Remove battery and check battery gauge. 2. If gauge shows battery is charged, then reinstall battery and retry. 3. If gauge shows battery is depleted, then either install a charged battery or connect external power and retry.
	Battery is improperly connected to the concentrator.	<ol style="list-style-type: none"> 1. Remove the battery and any external power connection. 2. Reinstall the battery, making sure it is completely inserted and retry. 3. Connect to either AC or DC external power and retry.
	Battery has performed a self-protect shutdown when there was no external power.	<ol style="list-style-type: none"> 1. Wait one minute and retry. 2. Change to an alternate battery or connect concentrator to either AC or DC external power and retry.

Concentrator is Beeping with No Lights or Display

Symptom	Probable Cause	Solution(s)
Concentrator is beeping with no lights or display.  Beeping will last less than two minutes if no power source is provided.	Battery has been removed or disconnected and there is no external power connected.	<ol style="list-style-type: none"> 1. Ensure the battery is completely inserted and restart. 2. Install a different charged battery and restart.
	When operating without a battery, external power is lost.	<ol style="list-style-type: none"> 1. Try another power outlet and check connections to concentrator and restart.

Battery Not Charging When External Power is Connected

Symptom	Probable Cause	Solution
With AC or DC power plugged into the concentrator, the external power icon is illuminated and battery charge level indicator is not flashing.	Power source is faulty, or there is a loose connection.	<ol style="list-style-type: none"> 1. Try another power outlet and check connections to concentrator.
	Battery is outside the allowed temperature range for charging.	<ol style="list-style-type: none"> 1. Allow concentrator and battery to cool down to less than 104°F (40°C), or warm up to 41°F (5°C).
	Battery is not fully seated.	<ol style="list-style-type: none"> 1. Ensure the battery is completely inserted.
	Battery charge is complete (all four segments of charge level indicator are illuminated).	<ol style="list-style-type: none"> 1. No action required.

No External Power Symbol Illuminated on Control Panel

Symptom	Probable Cause	Solution
With AC power plugged into concentrator, external power icon is not illuminated on the control panel.	Power source is faulty, or there is a loose connection.	<ol style="list-style-type: none"> 1. If the green indicator light on the AC adapter is lit, check power connections from the AC adapter to concentrator. 2. If the green indicator light on the AC adapter is not lit, check power connections from outlet to AC adapter or try another outlet.
With DC power plugged into concentrator, external power icon is not illuminated on the control panel.	Power source is faulty or there is a loose connection.	<ol style="list-style-type: none"> 1. Check power connections to concentrator. 2. Try another power outlet.
	The DC power cable fuse has blown.	<ol style="list-style-type: none"> 1. Switch to AC power and contact your provider to service the DC power cable.

7.2 Alarm Conditions



When any alarm condition occurs, the yellow alarm indicator light on the control panel illuminates and text describing the alarm condition is shown on the display screen. Refer to the solution section of the alarm tables for potential corrective actions. If necessary, contact your provider.

In all cases, pressing and holding the On/Off button for one second will turn off and reset the concentrator.

If the cause of the alarm condition is not corrected, it will reappear when the concentrator is turned back on.

All alarms are classified as Low Priority technical alarm conditions.

When multiple alarm conditions exist, the text associated with the highest ranked alarm will be shown on the display screen.

7.2.1 Operational Alarms

The concentrator continues to run when the alarm conditions listed in this section occur.

LCD DISPLAY TEXT:	DESCRIPTION:	SOLUTIONS:
No Breath Detected Check Cannula	Oxygen concentrator has not detected a breath over a 15 second period.	1. Verify cannula is connected, not kinked, properly positioned and user is breathing through his/her nose.
INDICATORS:		
Single audible beep every 30 seconds YELLOW alarm indicator illuminated		
NOTES:		
<p>Alarm will turn off when a breath is detected.</p> <p>This alarm does not apply during warm up.</p> <p>If no breath is detected for two minutes, the alarm will escalate to a shutdown alarm. Refer to Shutdown Alarms in Troubleshooting.</p> <p>The first occurrence of this alarm condition will cancel the audio off (mute) feature. Audio off (mute) can be reactivated. If reactivated, the alarm audio off (mute) feature will remain activated even if this alarm condition occurs again.</p>		
LCD DISPLAY TEXT:	DESCRIPTION:	SOLUTIONS:
Breath Rate High Reduce Activity	The user breath rate has exceeded the capacity of the concentrator for more than 15 seconds.	1. The user should immediately reduce his/her activity level to get his/her breath rate to slow down.
INDICATORS:		
Single audible beep every 30 seconds YELLOW alarm indicator illuminated		

LCD DISPLAY TEXT:	DESCRIPTION:	SOLUTIONS:
NOTES:		
<p>A sufficient reduction of the user's breath rate will automatically turn off the alarm.</p> <p>The first occurrence of this alarm condition will cancel the audio off (mute) feature. Audio off (mute) can be reactivated. If reactivated, the alarm audio off (mute) feature will remain activated even if this alarm condition occurs again.</p>		

LCD DISPLAY TEXT:	DESCRIPTION:	SOLUTIONS:
Low Battery Charge Concentrator	Remaining battery run time of approximately 30 minutes. Battery requires charging.	<ol style="list-style-type: none"> 1. Connect oxygen concentrator to either the AC or DC power or insert an alternate charged battery into the unit, OR 2. Insert an alternate charged battery into the unit. Remove the depleted battery and charge it with the external battery charger for future use.
INDICATORS: Single audible beep no repeat YELLOW alarm indicator illuminated Battery gauge: <ul style="list-style-type: none"> • Pulse Flow Settings P1–P3: only the lowest segment is illuminated • Pulse Flow Setting P4–P5: only the lowest two segments are illuminated 		
NOTES:		
<p>The alarm turns off when external power is connected or when a charged battery is installed.</p> <p>Alarm will turn off when a breath is detected.</p>		

LCD DISPLAY TEXT:	DESCRIPTION:	SOLUTIONS:
Low Battery Charge Now	Remaining battery run time of approximately 15 minutes or less. Battery requires charging.	<ol style="list-style-type: none"> 1. Connect oxygen concentrator to either the AC or DC power, OR 2. Insert an alternate charged battery into the unit. Remove the depleted battery and charge it with the external battery charger for future use, OR 3. If no other power source is available, change to another source of oxygen.
INDICATORS: Single audible beep every 30 seconds YELLOW alarm indicator illuminated Battery gauge: <ul style="list-style-type: none"> • Only the lowest segment is illuminated 	Loss of power is imminent.	

NOTES:

The alarm turns off when external power is connected or when a charged battery is installed.

The first occurrence of this alarm condition will cancel the audio off (mute) feature. Audio off (mute) can be reactivated. If reactivated, the alarm audio off (mute) feature will remain activated even if this alarm condition occurs again.

LCD DISPLAY TEXT:	DESCRIPTION:	SOLUTIONS:
Unit Hot Allow to cool	Concentrator is near its maximum operating temperature.	<ol style="list-style-type: none"> 1. Move concentrator to cooler surroundings. Allow concentrator to cool down to less than 104°F (40°C). 2. Clean intake filter screen.
INDICATORS: Single audible beep every 30 seconds YELLOW alarm indicator illuminated		

NOTES:

The alarm will turn off when the required internal operating temperature is reached.

LCD DISPLAY TEXT:	DESCRIPTION:	SOLUTIONS:
Unit Cold Allow to warm	Concentrator is near its minimum operating temperature.	1. Move concentrator to warmer surroundings. Allow concentrator to warm up to 41°F (5°C).
INDICATORS:		
Single audible beep every 30 seconds YELLOW alarm indicator illuminated		
NOTES:		
The alarm will turn off when the required internal operating temperature is reached.		

LCD DISPLAY TEXT:	DESCRIPTION:	SOLUTIONS:
Battery Hot Allow to cool	Battery is near its maximum operating temperature.	1. Move concentrator to cooler surroundings. Allow concentrator to cool down to less than 104°F (40°C), OR 2. Use AC or DC power and remove battery, OR 3. Insert an alternate charged battery and remove the hot battery.
INDICATORS:		
Single audible beep every 30 seconds YELLOW alarm indicator illuminated		
NOTES:		
The alarm will turn off when the required battery temperature is reached or if external power is connected and battery is removed.		

LCD DISPLAY TEXT:	DESCRIPTION:	SOLUTIONS:
Battery Cold Allow to warm	Battery is near its minimum operating temperature.	<ol style="list-style-type: none"> 1. Move concentrator to warmer surroundings. Allow concentrator to warm up to 41°F (5°C), OR 2. Use AC or DC power and remove battery, OR 3. Insert an alternate charged battery and remove the cold battery.
INDICATORS:		
Single audible beep every 30 seconds YELLOW alarm indicator illuminated		
NOTES:		
The alarm will turn off when the required internal operating temperature is reached or if external power is connected and battery is removed.		

LCD DISPLAY TEXT:	DESCRIPTION:	SOLUTIONS:
Low Oxygen See Manual	The oxygen output purity has fallen to a value between 73% and 87%.	<ol style="list-style-type: none"> 1. Verify concentrator is in recommended environmental temperature. Refer to Specifications in Technical Data. 2. Clean intake filter screen and ensure both intake and exhaust are not blocked. 3. Turn concentrator off, then on again to retry.
INDICATORS:		
Single audible beep every 30 seconds YELLOW alarm indicator illuminated		

LCD DISPLAY TEXT:	DESCRIPTION:	SOLUTIONS:
NOTES:		
<p>The alarm will turn on when the oxygen purity has dropped below 85%.</p> <p>The alarm will turn off when the oxygen output purity has increased above to 87%.</p> <p>The alarm limits have a tolerance of +/- 2%.</p> <p>Alarm signal generation may be delayed by up to 128 seconds due to the monitoring algorithm used to prevent nuisance alarms.</p> <p>Call your provider and report the problem if the warning continues with next use.</p>		

LCD DISPLAY TEXT:	DESCRIPTION:	SOLUTIONS:
<p>Cannot charge Allow to cool</p>	<p>Battery is too hot to allow the battery to charge.</p>	<ol style="list-style-type: none"> 1. Move concentrator to cooler surroundings. Allow concentrator to cool down to less than 104°F (40°C), OR 2. Remove battery (with AC or DC power connected) to allow battery to cool.
<p>INDICATORS:</p> <p>Single audible beep every 30 seconds YELLOW alarm indicator illuminated</p>	<p>This alarm only occurs when External Power is connected.</p>	
NOTES:		
<p>The alarm will turn off when the required battery temperature is reached, when the battery is removed, or when external power is disconnected.</p>		

LCD DISPLAY TEXT:	DESCRIPTION:	SOLUTIONS:
Cannot charge Allow to warm	Battery is too cold to allow the battery to charge.	<ol style="list-style-type: none"> 1. Move concentrator to warmer surroundings. Allow concentrator to warm up to 41°F (5°C), OR 2. Remove battery (with AC or DC power connected) to allow battery to warm.
INDICATORS:	This alarm only occurs when an external power source is connected.	
Single audible beep every 30 seconds YELLOW alarm indicator illuminated		
NOTES:		
The alarm will turn off when the required battery temperature is reached, when the battery is removed, or when external power is disconnected.		

LCD DISPLAY TEXT:	DESCRIPTION:	SOLUTIONS:
Sensor Fault See Manual	Oxygen sensor feedback is out-of-range. Sensor failure is likely.	<ol style="list-style-type: none"> 1. Turn concentrator Off, then On again to retry.
INDICATORS:		
Single audible beep every 30 seconds YELLOW alarm indicator illuminated		
NOTES:		
The alarm will turn off when the sensor feedback is back in range.		
Call your provider and report the problem if alarm continues.		

LCD DISPLAY TEXT:	DESCRIPTION:	SOLUTIONS:
Warming Up	The concentrator is still warming up after two minutes from initial start up. The oxygen output purity has not reached the minimum value listed in Specifications in Technical Data.	<ol style="list-style-type: none"> 1. Verify concentrator is in recommended environmental temperature. Refer to Specifications in Technical Data. 2. Clean intake filter screen and ensure both intake and exhaust are not blocked. 3. Allow concentrator to continue warming up for at least 15 minutes. 4. Turn concentrator off, then on again to retry.
INDICATORS:		
No audible beep YELLOW alarm indicator illuminated		
NOTES:		
<p>Depending on a variety of factors, it can take up to 15 minutes to reach the minimum specified oxygen purity.</p> <p>The alarm will turn off when the minimum oxygen output purity is reached.</p> <p>If the minimum oxygen output purity has not been reached within 15 minutes from initial start up, the alarm will become a Low Purity alarm condition.</p>		

7.2.2 Shut Down Alarms

The concentrator shuts down when the alarm conditions in this section occur.

LCD DISPLAY TEXT:	DESCRIPTION:	SOLUTIONS:
Shut Down No Breath Detected	Oxygen concentrator has not detected a breath for over a two minute period.	<ol style="list-style-type: none"> 1. Verify cannula is connected, not kinked, properly positioned and user is breathing through his/her nose. 2. Change to another source of oxygen if alarm continues.
NOTES:		
<p>This alarm does not apply during warm up.</p> <p>To clear alarm, turn the concentrator off. Complete solution 1 before restarting. Press and hold the On/Off button to power down the concentrator and restart.</p>		
LCD DISPLAY TEXT:	DESCRIPTION:	SOLUTIONS:
Shut Down Stuck button	A stuck button is detected upon connection to power source.	<ol style="list-style-type: none"> 1. Remove all power sources from concentrator. Press each control button looking for a stuck button. Reconnect power. 2. Change to another source of oxygen if alarm continues.
INDICATORS: Two audible beeps every 16 seconds YELLOW alarm indicator illuminated		
NOTES:		
<p>To clear alarm, turn the concentrator off. Complete solution 1 before restarting. Call your provider and report the problem if alarm continues.</p>		

LCD DISPLAY TEXT:	DESCRIPTION:	SOLUTIONS:
Shut Down Battery Depleted	Remaining battery capacity has been completely used. Battery requires charging.	<ol style="list-style-type: none"> 1. Connect oxygen concentrator to either the AC or DC power, OR 2. Insert an alternate charged battery. Remove the depleted battery and charge with the optional external battery charger accessory for future use, OR 3. If no other power source is available, change to another source of oxygen.
INDICATORS:	Concentrator function has shut down.	
Two audible beeps every 16 seconds YELLOW alarm indicator illuminated Battery gauge: <ul style="list-style-type: none"> • No segments illuminated 		
NOTES:		
To clear the alarm, the concentrator needs to be turned off. Complete solution 1 or 2 before restarting.		

LCD DISPLAY TEXT:	DESCRIPTION:	SOLUTIONS:
Shut Down Unit Too Hot	Concentrator is too hot to allow it to continue operating.	<ol style="list-style-type: none"> 1. Move concentrator to cooler surroundings. Allow concentrator to cool down to 104°F (40°C). 2. Use AC or DC adapter for power. 3. Clean intake filter screen. 4. Change to another source of oxygen while waiting.
INDICATORS:	Concentrator function has shut down.	
Two audible beeps every 16 seconds YELLOW alarm indicator illuminated	Internal fan will continue to run to help lower internal temperature.	
NOTES:		
To clear the alarm, turn the concentrator off. Complete solutions 1, 2, and/or 3 before restarting.		

LCD DISPLAY TEXT:	DESCRIPTION:	SOLUTIONS:
Shut Down Unit Too Cold	Concentrator is too cold to allow it to continue operating.	<ol style="list-style-type: none"> 1. Move concentrator to warmer surroundings. Allow concentrator to warm up to 41°F (5°C). 2. Use AC or DC adapter for power. 3. Change to another source of oxygen while waiting.
INDICATORS:	Concentrator function has shut down.	
Two audible beeps every 16 seconds YELLOW alarm indicator illuminated	Internal fan will continue to run to help increase internal temperature.	
NOTES:		
To clear the alarm, turn the concentrator off. Complete solutions 1, 2, and/or 3 before restarting.		

LCD DISPLAY TEXT:	DESCRIPTION:	SOLUTIONS:
Shut Down Battery Too Hot	Battery is too hot to allow the battery to continue operating.	<ol style="list-style-type: none"> 1. Move concentrator to cooler surroundings. Allow concentrator to cool down to less than 104°F (40°C), OR 2. Use AC or DC power and remove battery, OR 3. Insert an alternate charged battery and remove the hot battery, OR 4. Change to another source of oxygen if no other power source is available.
INDICATORS:	Concentrator function has shut down.	
Two audible beeps every 16 seconds YELLOW alarm indicator illuminated		
NOTES:		
To clear the alarm, turn the concentrator off. Complete solutions 1, 2, 3, or 4 before restarting.		

LCD DISPLAY TEXT:	DESCRIPTION:	SOLUTIONS:
Shut Down Battery Cold	Battery is too cold to allow the battery to continue operating.	<ol style="list-style-type: none"> 1. Move concentrator to warmer surroundings. Allow concentrator to warm up to 41°F (5°C), OR 2. Use AC or DC power and remove battery, OR 3. Insert an alternate charged battery and remove the cold battery, OR 4. Change to another source of oxygen if no other power source is available.
INDICATORS:	Concentrator function has shut down.	
Two audible beeps every 16 seconds YELLOW alarm indicator illuminated		
NOTES:		
To clear the alarm, turn the concentrator off. Complete solutions 1, 2, 3, or 4 before restarting.		

LCD DISPLAY TEXT:	DESCRIPTION:	SOLUTIONS:
Shut Down Oxygen Fault	The oxygen output purity has fallen to a value below 73%.	<ol style="list-style-type: none"> 1. Verify concentrator is in recommended environmental temperature. Refer to Specifications in Technical Data. 2. Clean intake filter and ensure both intake and exhaust are not blocked. 3. Change to another source of oxygen if alarm continues.
INDICATORS:	Concentrator function has shut down.	
Two audible beeps every 16 seconds YELLOW alarm indicator illuminated		
NOTES:		
To clear the alarm, turn the concentrator off. Complete Solution 1 and/or 2 before restarting. The alarm limit has a tolerance of +/- 2%		
Alarm signal generation may be delayed by up to 128 seconds due to the monitoring algorithm used to prevent nuisance alarms.		
Call your provider and report the problem if alarm continues.		

LCD DISPLAY TEXT:	DESCRIPTION:	SOLUTIONS:
Shut Down System Fault	Abnormal system condition has been detected.	<ol style="list-style-type: none"> 1. Turn the concentrator Off, then On again to retry. 2. Change to another source of oxygen if alarm continues
INDICATORS:	May be caused by malfunction of compressor, fan, pressure or software.	
Two audible beeps every 16 seconds YELLOW alarm indicator illuminated	Concentrator function has shut down.	
NOTES:		
<p>To clear the alarm, turn the concentrator off. Restart concentrator.</p> <p>Call your provider and report the problem if alarm continues.</p>		

LCD DISPLAY TEXT:	DESCRIPTION:	SOLUTIONS:
Not applicable. All power lost, display is blank.	All power sources have been lost/removed.	<ol style="list-style-type: none"> 1. Ensure the battery is completely inserted. 2. Check external power connections to the concentrator and to the power outlet. 3. Try another power outlet. 4. Change to another source of oxygen if alarm continues.
INDICATORS:	Concentrator function has shut down.	
Audible beeps every second for approximately 30 to 60 seconds No other control panel indicators illuminated		
NOTES:		
<p>This alarm occurs even if the concentrator is off when all power is removed.</p> <p>To clear the alarm, complete solutions 1, 2, or 3 before restarting.</p>		

8 Technical Data

8.1 Technical Description

The Invacare Platinum Mobile uses a molecular sieve and pressure swing adsorption methodology to produce the oxygen gas output. Ambient air enters the device, is filtered and then compressed. This compressed air is then directed into a nitrogen adsorbing sieve bed. Concentrated oxygen exits the opposite end of the sieve bed and is directed into an oxygen reservoir from which it is delivered to the patient.

The oxygen purity level of the output gas ranges from 87% to 95.6%. The oxygen is delivered to the patient through the use of a nasal cannula. A pulse dose delivery method is used. The concentrator detects the start of patient inhalation and delivers a measured pulse of oxygen. No further oxygen is delivered until the next patient inhalation is detected. The volume of oxygen delivered each minute is a fixed amount based on the selected pulse flow setting. The volume of each oxygen pulse will vary with the patient's breath rate such that the fixed minute volume is maintained.

The Invacare Platinum Mobile is capable of operation by the patient in a home, institution, vehicle, or other environments outside the home. Device standard power options include an AC to DC switching power adapter operating from an AC power outlet (100–240VAC, 50–60 Hertz nominal), a DC power cable operating from an accessory outlet typically found in a vehicle type environment (12 VDC nominal), and up to two rechargeable batteries.

No specific product knowledge or training is required to operate the product other than what is contained in this manual.

Service information will be available on request to qualified technical personnel ONLY.

8.1.1 Pneumatic Diagram

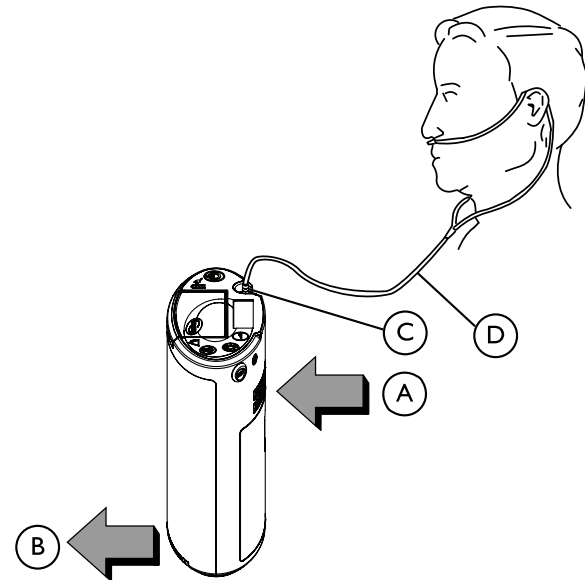

- (A) = Room Air In
- (B) = Exhaust Air Out
- (C) = Patient Outlet Fitting
- (D) = Nasal Cannula

8.2 Specifications

Electrical Requirements:	AC Power Supply: 110–240 VAC, 50–60 Hz DC Power Supply: 11–16 VDC
Rated Current Input:	5 A at 19 VDC, 10 A at 11–16 VDC
Power Consumption: (Typical)	Pulse Setting: P1 = 18 W P2 = 24 W P3 = 35 W P4–P5 = 45 W  Data is for concentrator operation only (no battery charging) utilizing an AC power source.
Operating Environmental Conditions: (All power sources)	Operating Temperature: 41°F to 104°F (5°C to 40°C) Relative Humidity: 15–90% non-condensing relative humidity, water vapor pressures up to 1.48 in Hg (50 hPa)
Storage and Transport Temperatures:	-13°F to 140°F (-25°C to 60°C)
Storage and Transport Humidity:	Up to 90% non-condensing relative humidity for temperatures of 41°F to 95°F (5°C to 35°C) Water vapor pressure up to 1.48 in Hg (50 hPa) for temperatures greater than 95°F (35°C)
Operating Altitude:	Up to 10,000 ft (3048 m) above sea level
Operating Atmospheric Pressure:	697–1060 hPa

Oxygen Purity:	87% to 95.6%, at all flow settings and over the rated ranges for ambient temperature, humidity and atmospheric pressure. After initial warm-up period (typically less than 5 minutes)
Conserver Trigger Sensitivity:	≤ 0.18 cmH ₂ O pressure drop (For all cannula lengths) Factory set—no adjustment, pressure activated Only patient respiratory efforts that achieve the trigger pressure will result in the delivery of an oxygen bolus.
Conserver Breath Rate Capacity:	15–40 BPM (breaths per minute) without reduction of bolus minute volume
Maximum Outlet Pressure:	28.5 psig (197 kPa)
Cannula Requirements:	Length: 4–25 ft (1.2–7.6 m) including all oxygen tubing Tubing: crush-proof, single lumen Adult, standard flow (rated for up to 6 L/min continuous flow) for lengths up to 7 ft) Adult, high flow (rated for up to 15 L/min continuous flow) for lengths greater than 7 ft to 25 ft) Example of Possible Cannula Model: Westmed Inc. Part Number 0194 (4 ft length)
Battery Specifications (each battery):	Rechargeable lithium-ion, 14.4 V, 5800 mAh, 83.5 Wh, 500 full charge/discharge cycle life
Battery Shelf Life:	12 months from date of manufacture

Battery Duration: (Times are approximate)	Condition	One Battery	Two Batteries
	Pulse Setting P1	5 hr 5 min	10 hr 10 min
	Pulse Setting P2	3 hr 30 min	7 hr 0 min
	Pulse Setting P3	2 hr 20 min	4 hr 40 min
	Pulse Setting P4–P5	1 hr 45 min	3 hr 30 min
Battery Charge Time: (Times are approximate)	Condition	One Battery	Two Batteries
	Concentrator On, Pulse Setting P1	2 hr 20 min	4 hr 40 min
	Concentrator On, Pulse Setting P2	2 hr 20 min	4 hr 40 min
	Concentrator On, Pulse Setting P3	2 hr 30 min	5 hr 0 min
	Concentrator On, Pulse Setting P4–P5	3 hr 10 min	6 hr 20 min
	Concentrator Off	2 hr 20 min	4 hr 40 min
Sound Pressure Level:	<p>≤ 40 dBA weighted for flow setting P2 (Tested per ISO 3744:2010 with microphone location as specified in ISO 8359:1996 subclause 4.6)</p> <p>≤ 65 dBA weighted for flow setting P4–P5 (Tested per ISO 80601–2–69 subclause 201.9.6.2.1.101)</p>		
Sound Power Level:	≤ 65 dBA weighted for flow setting P4–P5 (Tested per ISO 80601–2–69 subclause 201.9.6.2.1.101)		
Audible Signal Sound Pressure Level:	55 dBA +/- 5 dBA		
Dimensions:	9.4 in high x 7.4 in wide x 3.7 in deep (23.9 cm high x 18.8 cm wide x 9.4 cm deep)		
Weight: (Nominal)	<p>4.9 lbs (2.18 kg) with single battery and no carry bag</p> <ul style="list-style-type: none"> • Add 0.75 lbs (0.34 kg) for carry bag • Add 1.0 lbs (0.45 kg) for a second battery 		

Shipping Weight: (Nominal)	10.5 lbs (4.8 kg)
Classifications:	Class II Electrical Shock Protection, Type BF Applied Part, Continuous Operation
Ingress Protection Rating:	Concentrator—IP22 AC Power Adapter—IP21 Battery—Keep Dry
Applied Parts:	Cannula/Oxygen Tubing, Oxygen Outlet Port, Carry Bag

Delivered Oxygen Pulse Volumes:

- The nominal pulse volumes published in the following table is in milliliters at STPD (standard temperature and pressure dry) conditions and apply over the rated ranges for ambient temperature, humidity, and atmospheric pressure.
- Maximum variation from nominal: +/- 15%

4 ft to 25 ft Cannula/Oxygen Tubing Lengths						
	Breaths Per Minute					
	15	20	25	30	35	40
Pulse Setting = P1	14.7	11.0	8.8	7.3	6.3	5.5
Pulse Setting = P2	29.3	22.0	17.6	14.7	12.6	11.0
Pulse Setting = P3	44.0	33.0	26.4	22.0	18.9	16.5
Pulse Setting = P4	58.7	44.0	35.2	29.3	25.1	22.0
Pulse Setting = P5	66.7	50.0	40.0	33.3	28.6	25.0

8.3 Regulatory Listing

ETL certified complying with:	EN/IEC 60601-1; Ed: 3.1 EN/IEC 60601-1-2; Ed: 4 AAMI ES60601-1 (United States) CSA 22.2 No. 60601-1 (Canada) ISO 80601-2-69 ISO 80601-2-67 IEC 60601-1-6 IEC 60601-1-8 IEC 60601-1-11 RTCA DO 160G
-------------------------------------	---

8.4 Electromagnetic Compliance (EMC)

Guidance and manufacturer’s declaration—electromagnetic emission

The Device is intended for use in the electromagnetic environment specified below. The customer or the user of the Device should assure that it is used in such an environment.

Emissions test	Compliance	Electromagnetic environment - guidance
RF emissions CISPR 11	Group I	The Device uses RF energy only for its internal function. Therefore, its RF emissions are very low and are not likely to cause any interference in nearby electronic equipment.
RF emissions CISPR 11	Class B	The Device is suitable for use in all establishments including domestic establishments and those directly connected to the public low-voltage power supply network that supplies buildings used for domestic purposes.
Harmonic emissions IEC 61000-3-2	Class A	
Voltage fluctuations / flicker emissions IEC 61000-3-3	Complies	

Guidance and manufacturer’s declaration—electromagnetic immunity

The Device is intended for use in the electromagnetic environment specified below. The customer or the user of the Device should assure that it is used in such an environment.

Immunity test	IEC 60601 test level	Compliance level	Electromagnetic environment – guidance
Electrostatic discharge (ESD) IEC 61000-4-2	± 8 kV contact ± 15 kV air	± 8 kV contact ± 15 kV air	Floors should be wood, concrete or ceramic tile. If floors are covered with synthetic material, the relative humidity should be at least 30%.

Electrical Fast transient / burst IEC 61000-4-4	± 2 kV for power supply lines ± 1 kV for input/output lines	± 2 kV for power supply lines ± 1 kV for input/output lines	Mains power quality should be that of a typical commercial or hospital environment.
Surge IEC 61000-4-5	± 1 kV line(s) to line(s) ± 2 kV line(s) to ground	± 1 kV line(s) to line(s) ± 2 kV line(s) to ground	Mains power quality should be that of a typical commercial or hospital environment.
Voltage dips IEC 61000-4-11	0% U_T ; 1 cycle and 70% U_T ; 25/30 cycles Single phase: at 0°	0% U_T ; 1 cycle and 70% U_T ; 25/30 cycles Single phase: at 0°	Mains power quality should be that of a typical commercial or hospital environment. If the user of the Device requires continued operation during power mains interruptions, it is recommended that the Device be powered from an un-interruptible power supply or a battery. U_T is the a. c. mains voltage prior to application of the test level.
Voltage Interruptions IEC 61000-4-11	0% U_T ; 250/300 cycle	0% U_T ; 250/300 cycle	Mains power quality should be that of a typical commercial or hospital environment. If the user of the Device requires continued operation during power mains interruptions, it is recommended that the Device be powered from an un-interruptible power supply or a battery. U_T is the a. c. mains voltage prior to application of the test level.
Power frequency (50/60 Hz) magnetic field IEC 61000-4-8	30 A/m	30 A/m	Power frequency magnetic fields should be at levels characteristic of a typical location in a typical commercial or hospital environment.

<p>Conducted RF IEC 61000-4-6</p> <p>Radiated RF IEC 61000-4-3</p>	<p>3 V</p> <p>10 V/m</p>	<p>3 V</p> <p>10 V/m</p>	<p>Portable and mobile RF communications equipment should be used no closer to any part of the Device including cables, than the recommended separation distance calculated from the equation applicable to the frequency of the transmitter.</p> <p>Recommended separation distance:</p> <p>$d = 1.2\sqrt{P}$ 150 kHz to 80 MHz</p> <p>$d = 0.35\sqrt{P}$ 80 MHz to 800 MHz</p> <p>$d = 0.7\sqrt{P}$ 800 MHz to 2,5 GHz</p> <p>where P is the maximum output power rating of the transmitter in watts (W) according to the transmitter manufacturer and d is the recommended separation distance in metres (m).</p> <p>Field strengths from fixed RF transmitters, as determined by an electromagnetic site survey,^a should be less than the compliance level in each frequency range.^b</p> <p>Interference may occur in the vicinity of equipment marked with the following symbol:</p> <div style="text-align: center;">  </div>
--	--------------------------	--------------------------	--

^a Field strengths from fixed transmitters, such as base stations for radio (cellular/cordless) telephones and land mobile radios, amateur radio, AM and FM radio broadcast and TV broadcast cannot be predicted theoretically with accuracy. To assess

the electromagnetic environment due to fixed RF transmitters, an electromagnetic site survey should be considered. If the measured field strength in the location in which the Device is used exceeds the applicable RF compliance level above, the Device should be observed to verify normal operation. If abnormal performance is observed, additional measures may be necessary, such as reorienting or relocating the Device.

^b Over the frequency range 150 kHz to 80 MHz, field strengths should be less than [V1] V/m.

At 80 MHz and 800 MHz, the higher frequency range applies.

Recommended separation distances between portable and mobile RF communications equipment and the Device

The Device is intended for use in an electromagnetic environment in which radiated RF disturbances are controlled. The customer or the user of the Device can help prevent electromagnetic interference by maintaining a minimum distance between portable and mobile RF communications equipment (transmitters) and the Device as recommended below, according to the maximum output power of the communications equipment

Rated maximum output of transmitter [W]	Separation distance according to frequency of transmitter [m]		
	150 kHz to 80 MHz $d = 1.2\sqrt{P}$	80 MHz to 800 MHz $d = 0.35\sqrt{P}$	800 MHz to 2,5 GHz $d = 0.7\sqrt{P}$
0.01	0.12	0.04	0.07
0.1	0.37	0.11	0.22
1	1.17	0.35	0.70
10	3.69	1.11	2.21
100	11.67	3.50	7.00

For transmitters rated at a maximum output power not listed above the recommended separation, distance d in meters (m) can be estimated using the equation applicable to the frequency of the transmitter, where P is the maximum output power rating of the transmitter in watts (W) according to the transmitter manufacturer.

At 80 MHz and 800 MHz, the separation distance for the higher frequency range applies.



These guidelines may not apply in all situations. Electromagnetic propagation is affected by absorption and reflection from structures, objects and people.

9 Warranty

9.1 Limited Warranty

Refer to the warranty information included with your product for warranty details.

Invacare Corporation

USA

One Invacare Way
Elyria, Ohio USA
44035
440-329-6000
800-333-6900
Technical Services
440-329-6593
800-832-4707
www.invacare.com



Manufacturer

Invacare Corporation
2101 E. Lake Mary Blvd.
Sanford, FL USA 32773
407-321-5630



1194969-C 2018-10-09



Making Life's Experiences Possible®



Yes, you can.®

Invacare® Platinum® Mobile

POC1-100B, POC1-100C

en **Oxygen Concentrator
User Manual**

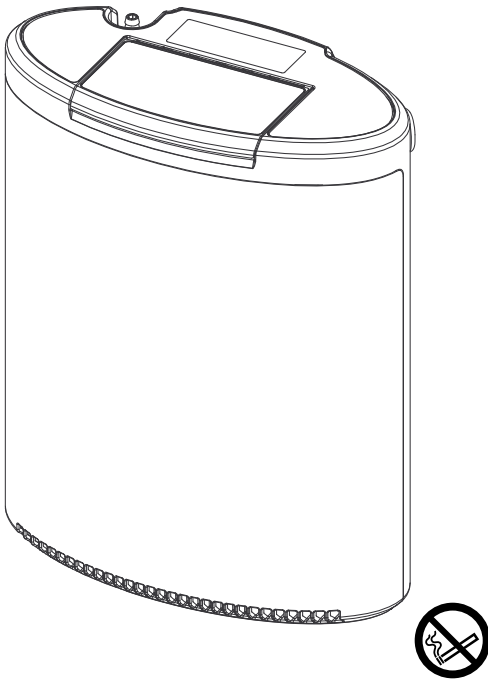

This manual **MUST** be given to the user of the product.
BEFORE using this product, this manual **MUST** be read and saved for
future reference.



Yes, you can.®

©2018 Invacare Corporation

All rights reserved. Republication, duplication or modification in whole or in part is prohibited without prior written permission from Invacare. Trademarks are identified by ™ and ®. All trademarks are owned by or licensed to Invacare Corporation or its subsidiaries unless otherwise noted.

Platinum is a registered trademark in the U.S.A., Europe and Australia.

Making Life's Experiences Possible is a registered trademark in the U.S.A.

Pine-sol, Lestoil and Clorox are registered trademarks of The Clorox Company.

Dawn is a registered trademark of The Procter and Gamble Company.

IOS is a trademark or registered trademark of Cisco in the U.S. and other countries and is used under license to Apple, Inc.

Android is a trademark of Google, LLC.

Bluetooth is a registered trademark of Bluetooth SIG, Inc.

Contents

1 General	5
1.1 Quick Start Guide	5
1.2 Symbols	9
1.3 Indications For Use	11
1.4 Intended Use	11
1.5 Contraindications	11
1.6 Features	12
1.6.1 Control Panel	12
1.6.2 Input/Output Connections	13
1.6.3 Filters	13
1.6.4 Power Options	14
1.6.5 Carry Bag	14
1.7 Optional Accessories and Replacement Parts	14
2 Safety	15
2.1 Label Locations	15
2.2 General Guidelines	17
2.3 Radio Frequency Interference	22
2.4 Traveling with the Concentrator	22
3 Setup	25
3.1 Unpacking	25
3.2 Inspection	25
3.3 Powering the Oxygen Concentrator	25
3.3.1 Installing the Battery(s)	26
3.3.2 Charging the Battery(s)	27
3.3.3 Reading the Battery Gauge for Installed and Uninstalled Battery(s)	28
3.3.4 Removing the Battery(s)	29
3.3.5 External AC Power	30
3.3.6 External DC Power	30
3.4 Carry Bag Setup	31
3.4.1 Installing the Carry Bag	31
3.4.2 Removing the Carry Bag	32
3.4.3 Installing Shoulder Straps	32
3.5 Connecting/Positioning the Nasal Cannula	33
4 Usage	35
4.1 Location	35
4.2 Concentrator Operating Position	35
4.3 Using the Carry Bag	35
4.4 Turning On the Concentrator	36
4.5 Turning Off the Concentrator	37
4.6 Warm Up Period	37
4.7 Breathing with the Use of the Concentrator	37
4.8 Reading the Display Screen	37
4.9 Adjusting the Pulse Flow Setting	38
4.10 Battery Life and Management	39
5 Maintenance	41
5.1 Maintenance	41
5.2 Service Life	41
5.3 Cleaning the Cabinet	41
5.4 Cleaning the Air Intake Filter Screen	42
5.5 Cleaning the Carry Bag	42
5.6 Cleaning and Disinfection Between Patients	43
5.7 Viewing Hour Meter	44
5.8 Preventative Maintenance Checklist	45
6 After Use	47
6.1 Storage	47
6.2 Disposal	47
6.3 Wear and Tear	48
7 Troubleshooting	49
7.1 Troubleshooting	49
7.2 Alarm Conditions	51
7.2.1 Operational Alarms	52
7.2.2 Shut Down Alarms	60
8 Technical Data	65
8.1 Technical Description	65
8.1.1 Pneumatic Diagram	65

8.2	Specifications	66
8.3	Regulatory Listing	70
8.4	Electromagnetic Compliance (EMC)	71
9	Warranty	76
9.1	Limited Warranty	76

1 General

1.1 Quick Start Guide



IMPORTANT!

- The Quick Start Guide is for reference ONLY. It is imperative to read the manual in its ENTIRETY for full instructions.



DANGER!

Risk of Death, Injury, from Electric Shock

To reduce the risk of burns, electrocution, death or injury to persons:

- DO NOT disassemble. Refer servicing to qualified service personnel. There are no user serviceable parts.



WARNING!

Risk of Injury or Damage

Use of this product outside of the intended use and specifications has not been tested and may lead to product damage, loss of product function, or injury.

- DO NOT use this product in any way other than described in the specifications and intended use sections of this manual.



DANGER!

Risk of Death, Injury Or Damage From Fire

Textiles, oil or petroleum substances, grease, greasy substances and other combustibles are easily ignited and burn with great intensity in oxygen enriched air and when in contact with oxygen under pressure. Smoking during oxygen therapy is dangerous and is likely to result in burns or death. To avoid fire, death, injury or damage:

- DO NOT SMOKE while using this device. DO NOT use near OPEN FLAME or IGNITION SOURCES.
- NO SMOKING signs should be prominently displayed.
- Avoid creation of any spark near oxygen equipment. This includes sparks from static electricity created by any type of friction.
- Use only oxygen compatible water-based lotions or salves before and during oxygen therapy. To verify, refer to the lotion/salve container for oxygen compatible water-based statement. If necessary, contact the manufacturer. DO NOT use any lubricants on concentrator unless recommended by Invacare.
- Keep the oxygen tubing, cord, AC adapter, and concentrator out from under such items as blankets, bed coverings, chair cushions, clothing, and away from heated or hot surfaces including space heaters, stoves, and similar electrical appliances.
- Make sure concentrator is off when not in use.







DANGER!

Risk Of Death, Injury Or Damage

Improper use of the product may cause death, injury or damage. This section contains important information for the safe operation and use of this product.

- DO NOT use this product or any available optional equipment without first completely reading and understanding these instructions and any additional instructional material such as user manuals, service manuals or instruction sheets supplied with this product or optional equipment.
- If you are unable to understand the warnings, cautions or instructions, contact a health care professional, dealer or technical personnel before attempting to use this equipment.
- Check ALL external components and carton for damage. In case of damage, or if the product is not working correctly, contact a technician or Invacare for repair.
- This product is intended to be used by adults only after reading and understanding the instructions and warnings of this user manual.
- THE INFORMATION IN THIS DOCUMENT IS SUBJECT TO CHANGE WITHOUT NOTICE.

<p>1.</p>	<p>Open the battery compartment door. With battery fuel gauge label facing toward the front of the oxygen concentrator, slowly lower battery A straight down into one of the two slots in the battery compartment.</p> <p>Refer to Installing the Battery(s) in Setup.</p>	
<p>2.</p>	<p>Connect the AC Power Adapter to the external power input connector B. Plug the AC cord into the electrical outlet.</p> <p>Refer to External AC Power in Setup.</p> <p> Using the concentrator for the first time requires the battery(s) to be charged. Refer to Charging the Battery(s) in Setup.</p>	
<p>3.</p>	<p>Connect the nasal cannula to the concentrator oxygen outlet port on your concentrator C. Oxygen will only be delivered while you are breathing through the nasal cannula connected to this device.</p> <p>Refer to Connecting/Positioning the Nasal Cannula in Setup.</p>	

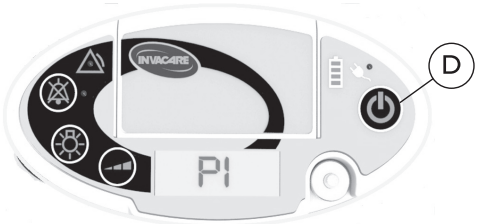
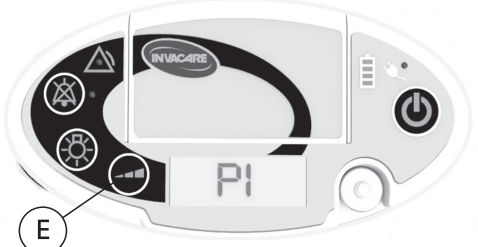
<p>4.</p>	<p>Turn on the concentrator by pressing the On/Off Button (D) until the control panel indicators light up.</p> <p>Refer to Turning on the Concentrator in Usage.</p>	 <p>The diagram shows the top control panel of the Invacare Platinum Mobile concentrator. It features a central LCD screen displaying 'PI', a battery level indicator, and several function buttons. A callout circle labeled 'D' points to the power button on the right side of the panel.</p>
<p>5.</p>	<p>Adjust the pulse flow setting to the one prescribed by your clinical professional. The pulse flow setting can be changed by pressing the flow selection button (E). Place the nasal cannula over your ears and position the prongs in your nose as instructed by your health care provider.</p> <p>Refer to Adjusting the Pulse Flow Setting in Usage.</p>	 <p>This diagram is identical to the one above, showing the control panel with the LCD screen displaying 'PI'. A callout circle labeled 'E' points to the flow selection button, which is located to the left of the power button.</p>

1.2 Symbols

Signal words are used in this manual and apply to hazards or unsafe practices which could result in personal injury or property damage. Refer to the information below for definitions of the signal words.



DANGER!

– Danger indicates an imminently hazardous situation which, if not avoided, will result in death or serious injury.



WARNING!

– Warning indicates a potentially hazardous situation which, if not avoided, could result in death or serious injury.



CAUTION!

– Caution indicates a potentially hazardous situation which, if not avoided, may result in property damage or minor injury or both.



IMPORTANT!













– Important indicates a hazardous situation that could result in damage to property if it is not avoided.









Gives useful tips, recommendations and information for efficient, trouble-free use.

Refer to the following table for the meaning of symbols marked on the equipment and/or packaging.

	<p>General Warning Sign</p> <p> The background color inside the triangle is yellow on product labels.</p>
	<p>Follow Instructions for Use</p> <p> The color of the symbol background is blue on product labels.</p>
	<p>No open flame</p> <p> The color of the circle with diagonal bar is red on product labels.</p>
	<p>DO NOT Smoke</p> <p> The color of the circle with diagonal bar is red on product labels.</p>
	<p>Consult Instructions for Use</p> <p> This symbol is located on the cannula packing.</p>
	<p>Direct Current</p>
	<p>Type BF Applied Part</p>

	Class II Equipment
	Power On/Off
	Data Output Terminal
	DO NOT dispose of in household waste
	Manufacturer
	Date of Manufacture
	Recycle
	Reference Number
	Serial Number
	DO NOT Reuse (Single Patient Use Only)  This symbol refers to the cannula which is for single patient use only.
	Latex Free

	Indoor Use ONLY  This symbol is included on the AC power adapter.
	DO NOT use oil or grease
	Keep dry
IP22	Protected against solid foreign objects of 12.5 mm diameter and greater. Protected against vertically falling water drops when enclosure tilted up to 15°.
IP21	Protected against solid foreign objects of 12.5 mm diameter and greater. Protected against vertically falling water drops.
	Transport and Storage Temperature
	Transport and Storage Humidity
	Electrical Safety Agency Certification Mark

1.3 Indications For Use

The Invacare® Platinum® Mobile Oxygen Concentrator is intended to provide supplemental oxygen to patients with respiratory disorders. The device can be used in a home, institution, vehicle, or other environments outside the home.

The Invacare Mobile Medical Application Accessory POC1-CONNECT is intended for use with the Invacare Platinum Mobile Oxygen Concentrator POC1-100B or POC1-100C device, to allow patients via their Android™ or iOS™ mobile phone or tablet to display device settings, and to collect device performance and usage information for maintenance/servicing purposes only.

1.4 Intended Use

The Invacare® Platinum® Mobile Oxygen Concentrator is intended to provide supplemental oxygen to patients with respiratory disorders. The Invacare® Platinum® Mobile Oxygen Concentrator can be used in a home, institution, vehicle, or other environments outside the home. The device is not intended to be life-supporting or life-sustaining.

The Invacare Mobile Medical Application Accessory POC1-CONNECT is intended to allow patients via their Android or iOS mobile phone or tablet to display device settings, and to collect device performance and usage information for maintenance/servicing purposes only.



WARNING!

Risk of Injury or Damage

Use of this product outside of the intended use and specifications has not been tested and may lead to product damage, loss of product function, or personal injury.

- DO NOT use this product in any way other than described in the specifications and intended use sections of this manual.

1.5 Contraindications



WARNING!

Risk of Injury

This product is to be used as an oxygen supplement and is not intended to be life-supporting or life-sustaining. ONLY use this product if the patient is capable of spontaneous breath, able to inhale and exhale without the use of a machine

- DO NOT use in parallel or series with other oxygen concentrators or oxygen therapy devices.



WARNING!

Risk of Minor Injury or Discomfort

The conserving, or pulse dose, oxygen delivery technique used by this device is contraindicated in persons whose breathing during normal resting would be unable to trigger the device.

- Proper device triggering, setup and operation must be confirmed by an experienced clinician or other respiratory professional.
- Not for pediatric use.
- Not for use by tracheotomized patients.

1.6 Features

1.6.1 Control Panel

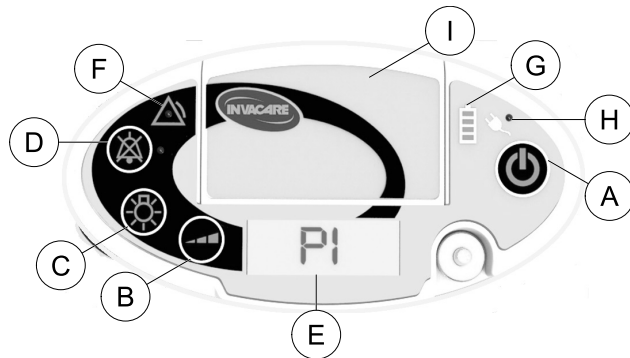

(A)	<p>On/Off Button</p> <p>Press for one second to turn concentrator on or off.</p>
(B)	<p>Flow Selection Button</p> <p>Press to adjust the pulsed oxygen flow to your prescribed setting. The selected flow setting is shown on the display screen. Refer to Adjusting the Pulse Flow Setting in Usage for more details.</p>
(C)	<p>Display Backlight Button</p> <p>Press once to illuminate the display screen for 5 seconds.</p>
(D)	<p>Audio Off Button</p> <p>Press to mute the audible signal (beep) for both alarms and status indications. The blue indicator light next to the button illuminates when activated. Audio off can be activated during or prior to an alarm condition occurring.</p>
(E)	<p>Display Screen</p> <p>Displays information about the operating status of the concentrator.</p>
(F)	<p>Alarm Indicator</p> <p>The yellow indicator light at the center of the triangular symbol illuminates to indicate abnormal operating conditions. Refer to Alarm Conditions in Troubleshooting for more details.</p>

Ⓒ	<p>Battery Gauge</p> <p>Indicates the charge status of the battery(s). Refer to Reading the Battery Gauge for Installed and Uninstalled Battery(s) in Setup for more details.</p>
Ⓓ	<p>External Power Indicator</p> <p>The orange indicator light next to the plug symbol illuminates when an external power source is connected to the concentrator.</p>
①	<p>Battery Compartment Door</p> <p>Used to access the removable battery(s).</p>

Not Shown	<p>Audible Signal (Beep)</p> <p>Indicates a change in operating status or a condition which requires the operator’s attention.</p>
-----------	---

1.6.2 Input/Output Connections

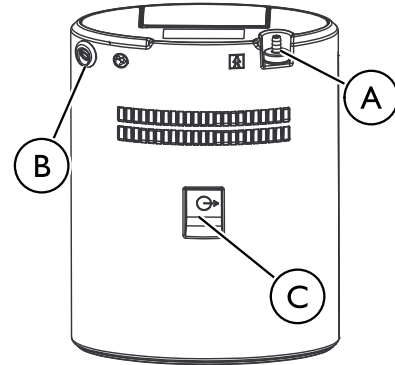

Ⓐ	<p>Oxygen Outlet Port</p> <p>Used to connect the nasal cannula to the concentrator.</p>
Ⓑ	<p>External Power Input Connector</p> <p>Used to connect an external power source to the concentrator.</p>
Ⓒ	<p>USB Port</p> <p>Used for service. Location of POC1–CONNECT Dongle.</p>

1.6.3 Filters

Air enters the concentrator through an air intake filter located on the carry bag. This filter prevents hair and other large particles in the air from entering the unit. Before you

operate the concentrator, make sure this filter is clean and dry, and the concentrator is properly installed in the carry bag.

To clean the air intake filter, refer to Cleaning the Air Intake Filter Screen in Maintenance.

To ensure the concentrator is properly installed in the carry bag, refer to Installing the Carry Bag in Setup.

1.6.4 Power Options



WARNING!

Risk of Injury or Damage

To avoid injury or damage which will void warranty:

- Use only Invacare specified power supplies.

Battery(s): Up to two rechargeable batteries can be installed in the battery compartment of the concentrator. When fully charged, a single battery supplies power for up to five hours (up to ten hours for two batteries). Visible and audible alarm signals occur when the battery power is getting low. Refer to Alarm Conditions in Troubleshooting and Charging the Battery(s) in Setup.

AC Power Adapter: An AC power adapter allows the concentrator to be connected to a 100–240 volt 50–60 hertz outlet. Use of the AC power adapter will allow the concentrator to operate and simultaneously recharge the installed battery. Refer to Charging the Battery(s) in Setup.

DC Power Cable: A DC power cable allows the concentrator to be connected to an automobile's (boat, motor home, etc.) 12-volt DC outlet. Use of the DC power cable will allow

the concentrator to operate and simultaneously recharge an installed battery(s). Refer to Charging the Battery(s) in Setup.

1.6.5 Carry Bag

The carry bag provides a convenient means to hold the concentrator while performing daily activities.

It can be configured as a messenger bag or backpack using the shoulder straps provided. Refer to Installing the Carry Bag in Setup.

1.7 Optional Accessories and Replacement Parts

The following optional accessories are available from Invacare:

- Additional batteries, model number: POC1–110
- External battery charger with power supply: POC1–115

The following replacement parts are available from Invacare:

- Battery, model number: POC1–110
- Carry Bag, model number: POC1–150
- DC power cable, model number: POC1–140
- AC power adapter with power cord: POC1–130
- USB Dongle, model number: POC1–CONNECT



These parts are base models. Please contact Invacare or your provider for country specific models.

2 Safety

2.1 Label Locations

 The label is located on the back of the concentrator. The serial number is located on the right side of label shown here.

Model POC1-100B

The concentrator has four pulse flow settings.

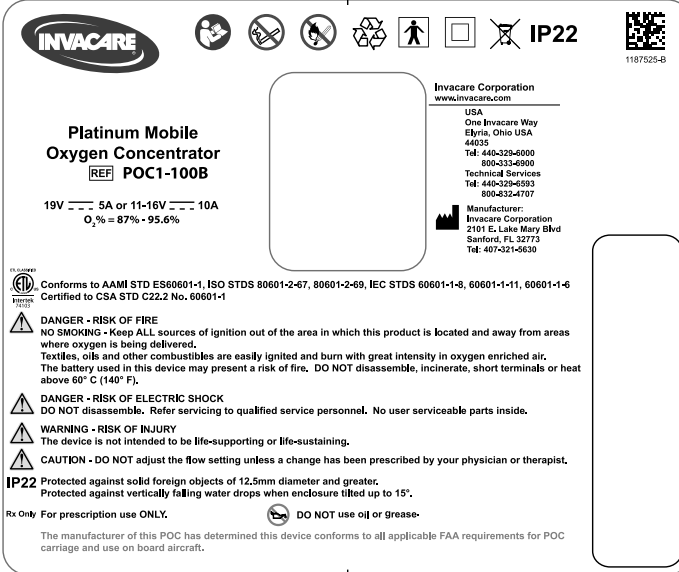

INVACARE

**Platinum Mobile
Oxygen Concentrator**
REF POC1-100B

19V --- 5A or 11-16V --- 10A
O₂ % = 87% • 95.6%

Invacare Corporation
www.invacare.com

USA
One Invacare Way
Elyria, Ohio USA
44035
Tel: 440-329-6000
800-333-6900
Technical Services
Tel: 440-329-6593
800-632-4707

Manufacturer:
Invacare Corporation
2101 E. Lake Mary Blvd
Sanford, FL 32773
Tel: 407-321-5630

1187525-B

Conforms to AAMI STD ES60601-1, ISO STDS 80601-2-67, 80601-2-69, IEC STDS 60601-1-8, 60601-1-11, 60601-1-6
Certified to CSA STD C22.2 No. 60601-1

⚠ DANGER - RISK OF FIRE
NO SMOKING - Keep ALL sources of ignition out of the area in which this product is located and away from areas where oxygen is being delivered.
Textiles, oils and other combustibles are easily ignited and burn with great intensity in oxygen enriched air. The battery used in this device may present a risk of fire. DO NOT disassemble, incinerate, short terminals or heat above 60° C (140° F).

⚠ DANGER - RISK OF ELECTRIC SHOCK
DO NOT disassemble. Refer servicing to qualified service personnel. No user serviceable parts inside.

⚠ WARNING - RISK OF INJURY
The device is not intended to be life-supporting or life-sustaining.

⚠ CAUTION - DO NOT adjust the flow setting unless a change has been prescribed by your physician or therapist.

IP22 Protected against solid foreign objects of 12.5mm diameter and greater.
Protected against vertically falling water drops when enclosure tilted up to 15°.

Rx Only For prescription use ONLY.  DO NOT use oil or grease-

The manufacturer of this POC has determined this device conforms to all applicable FAA requirements for POC carriage and use on board aircraft.

Model POC1-100C

The concentrator has five pulse flow settings.



**Platinum Mobile
Oxygen Concentrator**
REF **POC1-100C**

19V --- 5A or 11-16V --- 10A
O₂ % = 87% - 95.6%



IP22





60101892-A

Invacare Corporation
www.invacare.com

USA
One Invacare Way
Elyria, Ohio USA
44035
Tel: 440-329-6000
800-333-6900
Technical Services
Tel: 440-329-6593
800-832-4197

Invacare Corporation
2101 E. Lake Mary Blvd
Sanford, FL 32773
Tel: 407-321-5630

 Conforms to AAMI STD ES60601-1, ISO STDS 80601-2-67, 80601-2-69, IEC STDS 60601-1-8, 60601-1-11, 60601-1-6
Certified to CSA STD C22.2 No. 60601-1

 **DANGER - RISK OF FIRE**
NO SMOKING - Keep ALL sources of ignition out of the area in which this product is located and away from areas where oxygen is being delivered.
Textiles, oils and other combustibles are easily ignited and burn with great intensity in oxygen enriched air. The battery used in this device may present a risk of fire. **DO NOT** disassemble, incinerate, short terminals or heat above 60° C (140° F).

 **DANGER - RISK OF ELECTRIC SHOCK**
DO NOT disassemble. Refer servicing to qualified service personnel. No user serviceable parts inside.

 **WARNING - RISK OF INJURY**
The device is not intended to be life-supporting or life-sustaining.

 **CAUTION - DO NOT** adjust the flow setting unless a change has been prescribed by your physician or therapist.
IP22 Protected against solid foreign objects of 12.5mm diameter and greater.
Protected against vertically falling water drops when enclosure tilted up to 15°.

Rx Only For prescription use ONLY.  **DO NOT** use oil or grease.

The manufacturer of this POC has determined this device conforms to all applicable FAA requirements for POC carriage and use on board aircraft.

2.2 General Guidelines

In order to ensure the safe installation, assembly and operation of the concentrator these instructions **MUST** be followed.



DANGER!

Risk Of Death, Injury Or Damage

Improper use of the product may cause death, injury or damage. This section contains important information for the safe operation and use of this product.

- DO NOT use this product or any available optional equipment without first completely reading and understanding these instructions and any additional instructional material such as user manuals, service manuals or instruction sheets supplied with this product or optional equipment.
- If you are unable to understand the warnings, cautions or instructions, contact a health care professional, dealer or technical personnel before attempting to use this equipment.
- Check ALL external components and carton for damage. In case of damage, or if the product is not working correctly, contact a technician or Invacare for repair.
- This product is intended to be used by adults only after reading and understanding the instructions and warnings of this user manual.
- THE INFORMATION IN THIS DOCUMENT IS SUBJECT TO CHANGE WITHOUT NOTICE.



DANGER!

Risk of Death, Injury Or Damage From Fire

Textiles, oil or petroleum substances, grease, greasy substances and other combustibles are easily ignited and burn with great intensity in oxygen enriched air and when in contact with oxygen under pressure. Smoking during oxygen therapy is dangerous and is likely to result in burns or death. To avoid fire, death, injury or damage:

- DO NOT SMOKE while using this device. DO NOT use near OPEN FLAME or IGNITION SOURCES.
- NO SMOKING signs should be prominently displayed.
- Keep all open flames, matches, lighted cigarettes, electronic cigarettes or other sources of ignition at least 10 ft (3 m) away from this concentrator or any oxygen carrying accessories such as cannulas or tanks.
- If you disregard these warnings about the severe hazard of oxygen use while you continue to smoke, you must always turn off the concentrator, remove the cannula and then wait ten minutes before smoking or leave the room where either the concentrator or any oxygen carrying accessories such as cannulas or tanks are located.
- DO NOT SMOKE while using the concentrator.



CAUTION!

Federal (statutory) law restricts this device to sale by or on the order of a medical practitioner licensed by a governmental agency where he/she practices.

- ONLY a licensed medical practitioner may order the purchase or use of this device.



DANGER!

Risk of Death, Injury Or Damage From Fire

Textiles, oil or petroleum substances, grease, greasy substances and other combustibles are easily ignited and burn with great intensity in oxygen enriched air and when in contact with oxygen under pressure. To avoid fire, death, injury or damage:

- Avoid creation of any spark near oxygen equipment. This includes sparks from static electricity created by any type of friction.
- Use only oxygen compatible water-based lotions or salves before and during oxygen therapy. To verify, refer to the lotion/salve container for oxygen compatible water-based statement. If necessary, contact the manufacturer. DO NOT use any lubricants on concentrator unless recommended by Invacare.
- Keep the oxygen tubing, cord, AC adapter, and concentrator out from under such items as blankets, bed coverings, chair cushions, clothing, and away from heated or hot surfaces including space heaters, stoves, and similar electrical appliances.
- Make sure concentrator is off when not in use.

**CAUTION!****Risk of Minor Injury or Discomfort**

It is important to plan ahead for travel and other situations in which you may not have access to additional oxygen or power supplies. To prevent oxygen deprivation:

- Carry supplemental batteries with you.
- Stow the concentrator properly during travel.
For proper storage instructions when travelling refer to the travel guide.

**WARNING!****Risk of Injury or Damage**

To prevent injury or damage from misuse:

- NEVER leave concentrator unattended when connected to power.
- Make sure concentrator is off when not in use.
- Outdoor use MUST be conducted with internal battery power only.

**WARNING!****Risk Of Injury Or Damage**

- Invacare products are specifically designed and manufactured for use in conjunction with Invacare provided or Invacare specified accessories. Any other accessories have not been tested by Invacare and are not recommended for use with Invacare products.
- No modification of this equipment is allowed.

**CAUTION!****Risk of Minor Injury or Discomfort**

A change in altitude may affect total oxygen available to you. To prevent oxygen deprivation:

- Consult your physician before traveling to higher or lower altitudes to determine if your flow settings should be changed.

**DANGER!****Risk of Death, Injury, from Electric Shock**

To reduce the risk of burns, electrocution, death or injury to persons:

- DO NOT disassemble. Refer servicing to qualified service personnel. There are no user serviceable parts.
- Avoid using while bathing. If continuous usage is required by the physician's prescription, the concentrator must be located in another room at least 7 ft (2.5 m) from the bath.
- DO NOT come in contact with the concentrator while wet.
- DO NOT place or store concentrator where it can drop into water or other liquid.
- DO NOT reach for concentrator that has fallen into water. Unplug IMMEDIATELY.
- DO NOT block access to power outlet needed to unplug the AC power cord.
- DO NOT use frayed or damaged power cords.
- DO NOT use AC power adapter if its housing is cracked or separated.



WARNING!

Risk of Injury or Death

To prevent injury or death from product misuse:

- Closely supervise when this concentrator is used by impaired individuals or near children and/or impaired individuals.
- Monitor patients using this device who are unable to hear or see alarms or communicate discomfort.



CAUTION!

Risk of Minor Injury or Discomfort

While Invacare strives to produce the best oxygen concentrator in the market today, this oxygen concentrator can fail to produce oxygen due to power failure or device malfunction.

- ALWAYS have a backup source of oxygen readily available.
- In the event the concentrator fails to produce oxygen, the concentrator will briefly alarm signaling the patient to switch to their backup source of oxygen. Refer to Troubleshooting for more detail.
- Invacare recommends keeping at least one battery installed in the concentrator even when operating from an external power source.



WARNING!

Risk of Death, Injury or Damage

To prevent injury or damage from cord misuse:

- DO NOT move or relocate concentrator by pulling on the cord.
- DO NOT use extension cords with AC power adapters provided.
- Properly store and position electrical cords and/or tubing to prevent a tripping and strangulation hazards.



WARNING!

Risk of Injury or Damage

To prevent injury or damage during use:

- If you feel ill or uncomfortable, or if the concentrator does not signal an oxygen pulse and you are unable to hear and/or feel the oxygen pulse, consult your equipment provider and/or your physician IMMEDIATELY.
- For optimum performance, Invacare recommends that each use of the concentrator be a minimum of 30 minutes. Shorter periods of operation may reduce maximum product life.
- The concentrator should be used in an upright position.
- The concentrator cannot be used in conjunction with PAP, Bi-Level, mechanical ventilator or other such devices.

**CAUTION!****Risk of Minor Injury, Discomfort or Damage**

- Use of this device at an altitude above 10,000 ft (3048 m) or outside a temperature of 41°F to 104°F (5°C to 40°C) or a relative humidity above 90% is expected to adversely effect the flowrate and the percentage of oxygen and consequently the quality of therapy.

**WARNING!****Risk of Injury or Damage**

- As a safety feature, this appliance may have a polarized plug (one blade is wider than the other). To avoid injury or damage from electrical shock:
- This plug will fit in a polarized outlet only one way. If the plug does not fit fully in the outlet, reverse the plug. If it still does not fit, contact a qualified electrician.
 - DO NOT alter the plug in any way.
 - DO NOT use if the cord or plug are damaged. Call a qualified electrician for repair.

**CAUTION!****Risk of Damage**

- To prevent damage from temperature variations:
- DO NOT operate in temperatures below 41°F (5°C) or above 104°F (40°C).
 - When your automobile is turned off, disconnect the car accessory power cord and remove the concentrator from the automobile. DO NOT store the concentrator in a very hot or cold automobile or in other similar, high or low, temperature environments. Refer to Specifications in Technical Data.

**WARNING!****Risk of Injury or Damage**

- To prevent damage from liquid ingress:
- If the concentrator is not working properly, if it has been dropped or damaged, or dropped into water, call equipment provider/qualified technician for examination and repair.
 - NEVER drop or insert any object or liquid into any opening.
 - Invacare recommends the concentrator not be used in the rain.
 - The concentrator is not designed to be used with a humidifier. Use of this device with a humidifier may impair performance and/or damage the equipment.
 - DO NOT use if cabinet of concentrator or housing of AC power adapter is cracked or separated.

2.3 Radio Frequency Interference

Medical Electrical Equipment needs to be installed and used according to the EMC information in this manual.

This equipment has been tested and found to comply with EMC limits specified by IEC/EN 60601-1-2. These limits are designed to provide a reasonable protection against electromagnetic interference in a typical home health care environment.

Portable and mobile RF communications equipment can affect the operation of this equipment. Use of this equipment adjacent to or stacked with other equipment should be avoided as it could result in improper operation. The concentrator operation should be observed to verify normal operation in the presence of such equipment.

Other devices may experience interference from even the low levels of electromagnetic emissions permitted by the above standards. To determine if the emissions from the concentrator are causing the interference, turn the concentrator off. If the interference with the other device(s) stops, then the concentrator is causing the interference. In such rare cases, interference may be reduced or corrected by one of the following measures:

- Reposition, relocate, or increase the separation between the equipment.
- Connect the equipment into an outlet on a circuit different from that to which the other device(s) is connected.

Refer to Electromagnetic Compliance (EMC) in Technical Data for additional information.

2.4 Traveling with the Concentrator

Before Traveling

1. Contact your travel carrier and/or tour guide about your travel plans and provide information about your intent to use a portable oxygen concentrator during your travels. The carrier will let you know if you will be permitted to use your concentrator during your travel and if there are any restrictions for use.



If you are not permitted to use your concentrator on the carrier of choice and still want to take it with you:

- Carry it and any supplemental batteries on board with you.
 - Ensure the unit is turned off.
 - Stow it properly for the trip.
 - DO NOT place the concentrator or any supplemental batteries in checked baggage.
2. Contact the carrier to see if they have seats with a power outlet that you can use to power the concentrator during travel. If a power outlet is not available, be sure to bring enough supplemental batteries to last 150% of the travel time.



There may be unexpected delays beyond scheduled travel times. Carry your power adapters with you so you can recharge batteries before and after the trip.

3. Charge the installed battery of the concentrator and any supplemental batteries fully before you depart, thus extending the operating time of the concentrator during travel. Refer to Charging the Battery(s) in Setup.
4. Ensure the unit is free of all grease, oil, or other petroleum products and that the unit is in good working order, is free of damage, and the air filter is clean. Refer to the Preventative Maintenance Checklist in Maintenance.
5. Contact your oxygen supplier to make arrangements if you need to have backup oxygen at your destination.

Traveling By Air

Arriving at the Airport

1. Allow the security agent to inspect your concentrator, even if you are using it, when going through the security checkpoint.



They are required to allow you to travel through the checkpoint with your concentrator, but they MUST inspect it for security reasons.

2. Use your AC power adapter while you are in the airport, if possible. This will keep the battery(s) at full charge and give you the most battery powered operating time on the aircraft.

Boarding the Plane



You are not permitted to sit in an exit row if you plan to use your concentrator at any time during the flight.

1. If you plan on using the concentrator the entire time you are on the plane, verify that your concentrator does not block access to an emergency exit or aisle way. If it does, request a seat change.
2. In order for the flight crew to ensure the safety of you and all of the other passengers on the flight, allow them to inspect the concentrator to confirm that it is FAA approved for use on the flight.
3. If you are not planning to use your concentrator during taxi, takeoff, or landing, you MUST store it in an approved storage area so it does not block the row or aisle access.



Contact the flight crew about location of approved storage areas.

On the Plane



You MUST store the supplemental battery either securely connected to the concentrator or in your carry-on baggage. The supplemental battery MUST be protected from damage and shorting out the external power connector.

1. You may use your concentrator when moving about the cabin, **ONLY** after the pilot turns off the “Fasten Seat Belt” sign.
2. Turn off the unit if the concentrator alarms during the flight, unless the alarm resets itself. If the alarm does not reset, the concentrator **MUST** be turned off and stored in an approved storage area.
3. If an AC power outlet with a minimum 100W capacity is available on the flight, perform the following:
 - a. Connect the power adapter to the concentrator.
 - b. Plug in the power adapter into the airline power outlet.
 - c. Turn the unit on.



If you have any trouble making the connections to the plane’s power outlet, contact the flight crew for assistance.

After the Flight

1. Ensure you have enough power to run your concentrator while leaving the airport. Recharge the battery(s), if necessary. Refer to Charging the Battery(s) in Setup.
2. Contact your medical gas supplier to obtain your backup oxygen supply, if necessary.

Traveling by Boat

Contact the cruise line and inform them you are traveling with a concentrator. There should be no restrictions on your use of the concentrator during your travel, but it is wise to check with them ahead of time. Power should be available for use of your AC power adapter during your travels, but check first.

Traveling by Train

Contact the train authorities at least twelve hours ahead of arrival that you are going to use your concentrator. There should be no restrictions on your use of the concentrator, but power on the train may not be available for your use during travel times. Ensure there is enough battery life for your trip before you leave.

Traveling by Bus

Contact the bus line about using a concentrator. There should be no restrictions on your use of the concentrator during your trip, but power may not be available for your use during travel times. Ensure there is enough battery life for your trip before you leave.

Traveling by Car

There should be no restrictions on your use of the concentrator during your trip, but power may not be available for your use during travel times. Ensure there is enough battery life for your trip before you leave.

3 Setup

3.1 Unpacking

1. Check for any obvious damage to the carton or its contents. If damage is evident, notify the carrier or your local dealer.
2. Remove all loose packing from the carton.
3. Carefully remove all the components from the cartons. The Invacare concentrator's packaging contains the following items (as shown below) in addition to this user manual. If any parts are missing, please contact your equipment provider.
 - Concentrator (Model POC1–100B) with carry bag (Model POC1–150) installed
 - Cannula (Westmed #0194)
 - Two shoulder straps (Part Number 1187483)
 - Battery (Model POC1–110)
 - AC power adapter (Part Number 1187452)
 - AC power cord (Part Number 1187454 for model POC1–100B)
 - DC power cable (Model POC1–140)



Retain all containers and packing materials for storage or return shipment.

3.2 Inspection

Inspect/examine exterior of the oxygen concentrator and accessories for damage. Inspect all components. If damage is found, DO NOT use concentrator. Contact your provider for service and/or repair or for assistance with the setup procedure and to report unexpected operation or events.

3.3 Powering the Oxygen Concentrator



WARNING!

Risk of Injury or Damage

To avoid injury and damage that will void the warranty:

- Use only Invacare specified power supplies with the oxygen concentrator.
- Prior to using the DC power cable, the automobile (boat, motor home, etc.) engine should be running in order to either operate or charge the oxygen concentrator.



IMPORTANT

The concentrator will not turn on unless the battery is charged.

- Connect AC power to the concentrator and allow battery to fully charge prior to first use.

The oxygen concentrator allows the freedom to choose from the following power sources to enable use both inside and outside of the home:

- Rechargeable battery(s)
- AC power outlet
- 12 volt DC power cable

3.3.1 Installing the Battery(s)



DANGER!

Risk of Death, Injury or Damage

To avoid death, injury or damage from fire:

- DO NOT heat above 140°F (60°C), incinerate, disassemble, or short terminals.
- Dispose in accordance with all local regulations.

The oxygen concentrator comes equipped with a single rechargeable lithium battery. Up to two batteries can be installed in the concentrator. When fully charged, a single battery supplies power for up to five hours, depending on the pulse flow setting. Two batteries can supply power for up to ten hours when fully charged, depending on the pulse flow setting.

A battery can be installed while the concentrator is operating from an external power source or a second charged battery.

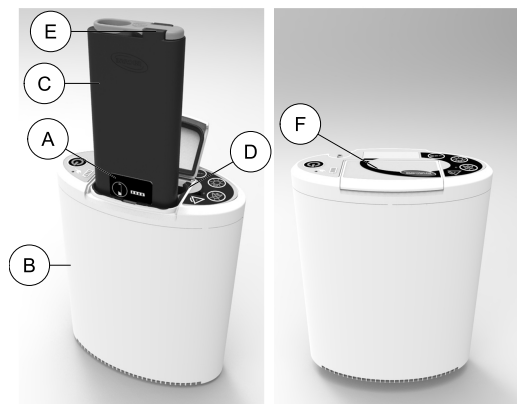

1. Open the battery compartment door (F).
2. With battery fuel gauge label (A) facing toward the front of the oxygen concentrator (B), slowly lower battery (C) straight down into one of the two slots in the battery compartment (D).



Use the lift ring (E) to hold the battery while installing it.

The battery will not fit properly in the battery compartment if not oriented as described above.

3. Ensure the battery fully engages the battery connections located at the bottom of the battery compartment. When fully inserted, the top of the battery is level with the top edge of the battery compartment.



CAUTION!
Risk of Damage

To avoid damage to battery connections from excessive force or misuse:

- DO NOT slam or force battery(s) into place.
- Orient the battery(s) as described in the instructions prior to installing.

To avoid damage to the battery door from excessive force or misuse:

- DO NOT lift concentrator using the battery door.
- Make sure battery(s) are fully installed before closing this battery door.
- DO NOT use concentrator with battery door open.

4. If a second battery is being used (sold separately), install it in the same manner in the unoccupied battery slot.
5. Close the battery compartment door (E).

3.3.2 Charging the Battery(s)

Initial Charging of the Battery(s)

Using the concentrator for the first time requires the battery(s) to be charged. Batteries are shipped in a “sleep” mode and an initial charge cycle is required to “wake”

up the batteries. To charge the battery(s), perform the following steps:

1. Install the battery. Refer to Installing the Battery(s) in Setup.
2. Connect AC power to the concentrator. Refer to External AC Power in Setup.
3. Monitor the battery charge level and charge until full. Refer to Battery Gauge for Installed and Uninstalled Battery(s) in Setup.
4. Disconnect the AC power adapter from the concentrator for portable operation.



IMPORTANT

A concentrator will not turn on unless the battery is charged.

- Connect the AC power to the concentrator and allow battery to fully charge prior to first use.
- Refer to Specifications in Technical Data for approximate charge times.

Charging the Battery(s) After Initial Charging



The installed battery(s) can be charged whether the concentrator is on or off.

1. For charging of the battery(s) after initial charging, do one of the following:
 - Connect the AC power adapter (if charging from a wall outlet). Refer to External AC Power in Setup.
 - Connect the DC power cable (if charging from a vehicle). Refer to External DC Power in Setup.
 - Remove battery and charge with the optional External Battery Charger accessory, Model POC1–115.
2. Monitor the battery charge level and charge until full. Refer to Battery Gauge for Installed and Uninstalled Battery(s) in Setup.
3. Disconnect external power from the concentrator for portable operation.

3.3.3 Reading the Battery Gauge for Installed and Uninstalled Battery(s)

Battery Gauge for Installed Battery(s)

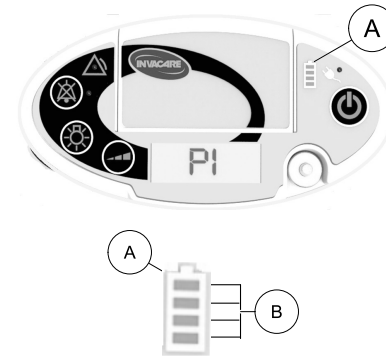

The battery gauge ① shows the status of the installed battery charge level when the concentrator is turned on and when the concentrator is off but connected to an external power source. The number of illuminated segments ② of the battery gauge ① indicates the charge level of the installed battery. If two batteries are installed the indicated charge level is that of the least charged battery.

Number of Lit Segments ②	Charge Level
1	0–25% charge
2	26–50% charge
3	51–75% charge
4	76%-100% charge

When the concentrator is connected to an external power source (whether the concentrator is turned on or off) the “last” or “highest” segment ② of the battery gauge ① also

flashes to show the battery is charging. When the battery is fully charged, the fourth segment **B** of the battery gauge **A** stops flashing and remains lit.

Battery Gauge for Uninstalled Battery(s)

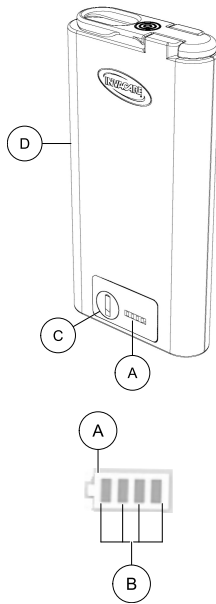

When the battery **D** is removed from the concentrator, press the battery status button **C** to show the status of the charge level on the battery gauge **A**. Refer to the charge level **B** table in Reading the Battery Gauge for Installed and Uninstalled Battery(s) in Setup.

1194969-C

3.3.4 Removing the Battery(s)

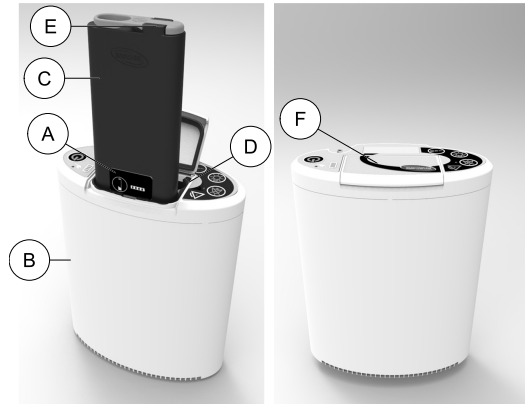

1. Open the battery compartment door **F** of the concentrator **B**.
2. Pull straight up on the lift ring **E** to remove the battery **C** from the battery compartment **D**.
3. If a second battery is being used (sold separately), remove it in the same manner.
4. Close the battery compartment door.



A steady audible beep will occur when all power sources are removed from the concentrator. Refer to Shut Down Alarms in Troubleshooting.

A battery can be removed without affecting the operation of the concentrator as long as an external power source or a second charged battery is installed.

3.3.5 External AC Power

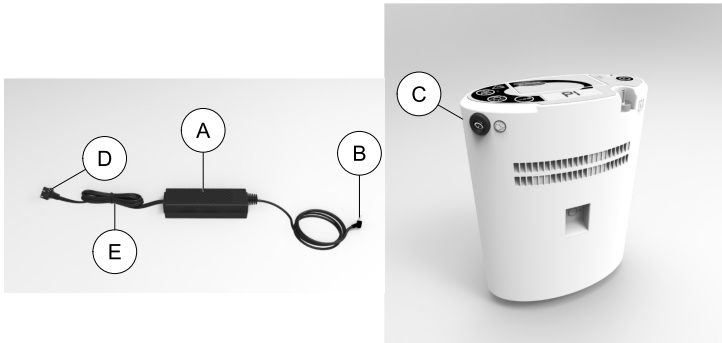

The AC power adapter (A) allows the oxygen concentrator to be connected to a 100–240 volt 50–60 Hertz outlet (i.e. wall outlet of your home). The power adapter converts AC voltage to a DC voltage that can be used to power the oxygen concentrator. Use of the AC power adapter will allow the oxygen concentrator to operate and simultaneously recharge the battery(s).

Complete the following steps to connect the AC power adapter to the concentrator:

1. If not already assembled, attach the AC power cord (E) to the AC power adapter (A).
2. Insert the AC power adapter outlet connector (B) into the external power input connector (C) of the concentrator.
3. Insert plug (D) into an AC outlet.



The external power input connector of the concentrator is angled slightly upward. The outlet connector of the power cord needs to be angled slightly upward when installed.

When a battery is installed, external AC or DC power can be connected or disconnected whether the concentrator is off or on.

When an external power source is properly connected to the concentrator, the orange indicator light next to the plug symbol on the control panel will illuminate and there will be an audible beep. When external power is disconnected, the orange light will turn off and there will be an audible beep.

3.3.6 External DC Power

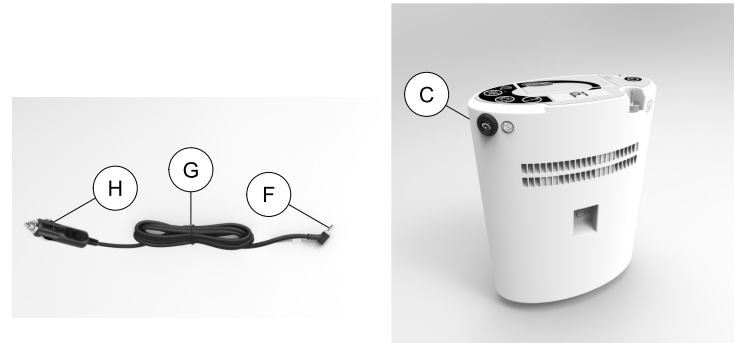

The DC power cable (G) allows the oxygen concentrator to be connected to an automobile's (boat, motor home, etc.) 12-volt DC outlet. Use of the DC power cable will allow

the oxygen concentrator to be operated and simultaneously recharge the battery.

Complete the following steps to connect the DC power cable to the concentrator:

1. Insert the DC power cable outlet connector **F** into the external power input connector **C** of the concentrator.
2. Insert plug **H** into a DC outlet after the automobile (boat, motor home, etc.) is running.

3.4 Carry Bag Setup



CAUTION! Risk of Damage

- Improper installation of the concentrator into the carry bag can cause a high temperature alarm condition and result in the concentrator shutting down.
- The carry bag is not designed to protect the concentrator from excessive drops, impacts, or abuse.
- To install or remove the carry bag the concentrator must be off and disconnected from external power and cannula.



Concentrator can be operated with or without the carry bag. When out of the carry bag, the concentrator is limited to stationary use. Refer to Using the Carry Bag in Usage.

3.4.1 Installing the Carry Bag

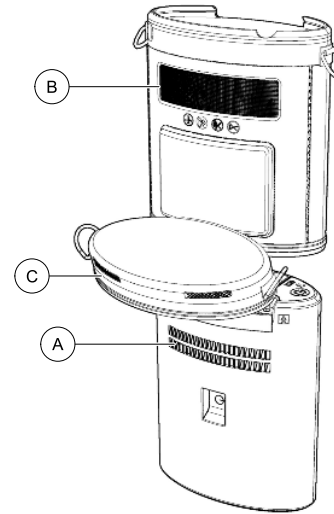

1. Fully unzip the base of the carry bag.
2. Position the concentrator standing upright on a flat surface and oriented with air intake opening **A** facing you. Ensure the concentrator is off and disconnected from external power and cannula.
3. Position the carry bag above the concentrator with the air intake filter screen **B** facing you.
4. Hold the unzipped bottom of the carry bag open **C**, and slide the carry bag down onto the concentrator until the carry bag completely covers the concentrator.

5. Lay the concentrator and carry bag down with air intake filter screen facing upward.
6. Push the concentrator into the carry bag until it is fully seated against the top retainer.
7. Rotate the base of the carry bag onto the bottom of the concentrator and fully zip up the bottom of the carry bag.
8. Return the concentrator and carry bag to the upright position.
9. Check that the cutouts in the top retainer are correctly aligned with the oxygen outlet port and external power input connector. If not aligned, remove the carry bag and reinstall as described in steps 1–9.

3.4.2 Removing the Carry Bag

1. Ensure the concentrator is off and disconnected from external power and cannula.
2. Lay the concentrator on a flat surface with the air intake filter screen facing upward and fully unzip the base.
3. Rotate the base of the carry bag off the bottom of the concentrator.
4. From the bottom, pull the concentrator out of the carry bag. If needed, the top surface of the concentrator can be pushed to help remove it from the bottom of the carry bag.
5. Return the concentrator to the upright position.
6. Fully zip up the bottom of the carry bag.

3.4.3 Installing Shoulder Straps



The carry bag can be configured as a messenger bag using one shoulder strap or as a back pack using two shoulder straps.



Messenger Bag Configuration

1. Using a single shoulder strap (A), attach a clip (B) from each end of the strap to rings (C) at the top of the carry bag (D).
2. Adjust shoulder strap to desired length.
3. Slide pad (E) on shoulder strap to the desired location.

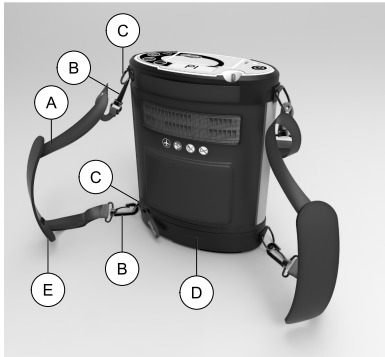

Back Pack Configuration

1. Attach each clip **B** at the ends of a single shoulder strap **A** to the two rings **C** located at the top and bottom of the carry bag **D**.
2. Repeat for the second strap on the opposite side.
3. Adjust each shoulder strap to desired length.
4. Slide pad **E** on each shoulder strap to the desired location.

3.5 Connecting/Positioning the Nasal Cannula



DANGER!

Risk of Injury or Death

The cannula can cause tripping, falling, or other injury if improperly positioned and secured. To avoid injury or death:

- The cannula **MUST** be routed and secured properly.
- **DO NOT** position the cannula around the neck. Ensure the patient can move freely while wearing the cannula.
- Avoid positioning cannulas across areas of high foot traffic (i.e. aisles, doorways, hallways, etc.)



WARNING!

Risk of Injury or Death

To avoid choking and/or strangulation from tubing entanglement:

- Keep children and pets away from nasal cannula and tubing.
- Close supervision is necessary when the nasal cannula is used by impaired individuals or near children and/or impaired individuals.



WARNING!

Risk of Injury or Death

To reduce the risk of injury or death from illness:

- Replace the nasal cannula on a regular basis. Check with your equipment provider or physician to determine how often the cannula should be replaced.
- DO NOT share cannulas between patients. Cannulas are for single patient use only.



CAUTION!

Risk of Damage

- Use of sterilization or cleaning solutions may leave this device nonfunctional.



CAUTION!

Risk of Minor Injury or Discomfort

To ensure proper breath detection and oxygen delivery:

- Ensure the cannula prongs are positioned properly in your nose. This is critical to the effectiveness of the oxygen therapy.
- DO NOT use tubing/cannula length exceeding 25 ft (7,6 m).
- Use crush-proof oxygen tubing.
- Use ONLY single lumen cannulas with the flow characteristics stated in Specifications in Technical Data.
- Avoid use of concentrator in windy conditions.
- Check for gas flow at the outlet of the cannula.

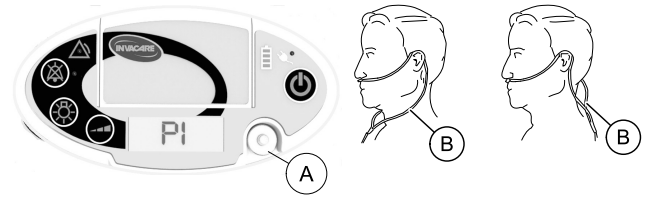

1. Remove the cannula from its packaging.
2. Connect the cannula to the concentrator oxygen outlet port **A**. Ensure the connection is secure.
3. Place the cannula **B** over your ears and position the prongs in your nose as instructed by your health care provider or cannula manufacturer.



Gas flow at the outlet of the cannula can be checked while the concentrator is warming up. Wave your hand in front of the nasal prongs. You should be able to hear and feel the pulsed flow of gas. If you do not feel the gas pulse, check the cannula connection for leaks.

4 Usage

4.1 Location

The concentrator can be used in a home, institution, vehicle or other environments outside the home.



WARNING!

Risk of Injury or Damage

To avoid injury or damage from airborne pollutants and/or fumes and for optimal performance:

- Locate and position the concentrator in a well ventilated space so that the air intake and the air exhaust openings are not obstructed.
- NEVER block the air openings of the concentrator or place it on a soft surface, such as a bed or couch, where the air opening may be blocked.
- Keep the openings free from lint, hair and similar foreign items.
- Keep concentrator at least 12 in (30.5 cm) away from walls, draperies and furniture.
- DO NOT use in presence of pollutants, smoke or fumes, flammable anesthetics, cleaning agents or chemical vapors.



Refer to Using the Carry Bag in Usage for detail on the location of the air intake and exhaust openings.

4.2 Concentrator Operating Position

When not being worn, the concentrator should be operated in the upright position and placed on a firm, level surface.



The concentrator should be in a location where the audible signal can be heard.

4.3 Using the Carry Bag



WARNING!

Risk of Injury or Damage

To avoid injury or damage from dropping the concentrator or incorrect positioning of the concentrator:

- The carry bag must be used for portable operation of the concentrator.
- DO NOT adjust the shoulder strap while carrying the concentrator.
- Position concentrator so exhaust vents are directed away from the body and control panel faces upward.
- Use only Invacare carry bag, model POC1–150.



CAUTION!

Risk of Minor Injury or Discomfort

To avoid injury from concentrator malfunctioning:

- Ensure you are able to hear the audible signal warnings when using the carry bag as a backpack in case an alarm condition occurs.

The carry bag can be configured as a messenger bag using one shoulder strap or as a backpack using two shoulder straps. The length of the shoulder strap(s) can be adjusted

to the desired position. Refer to Installing Shoulder Straps in Setup.



Messenger Bag Configuration



Backpack Configuration

When carrying the concentrator with the shoulder strap(s) (A), position the concentrator with the control panel facing upward and the air intake (C) opening towards the body. This orients the concentrator so that the exhaust vent (B)

is directed away from the body and the control panel is positioned for proper viewing.

The carry bag also has a handle (D) that can be used to move and position the concentrator.

4.4 Turning On the Concentrator



1. To turn on the concentrator press the On/Off button (A) until you see the control panel indicators light up.
2. The audible signal will beep and all the indicators will light up for approximately two seconds after the unit is first turned on. This power up sequence provides the opportunity to ensure that all indicators are functioning properly.
3. Following the power up sequence a warm up period begins. For more details, refer to Warm Up Period in Usage.

4.5 Turning Off the Concentrator

1. To turn off the concentrator press the On/Off button until “Powering Down” is shown on the display screen.
2. The power down sequence takes a approximately three seconds.

4.6 Warm Up Period



CAUTION!

Risk of Minor Injury or Discomfort

During the warm up period (typically less than five minutes) oxygen output is not within specifications listed in Specifications in Technical Data.

- Concentrator may be used during warm up period.

After turning on the concentrator a warm up period of up to 15 minutes is needed to reach the specified oxygen purity. “Warming Up” is shown on the display screen during this period.

While warming up, the concentrator will automatically deliver a pulse of oxygen about every four seconds when no breath is detected. The nasal cannula should be connected to the concentrator during warm up period.

When the concentrator has finished warming up, the current pulse setting will be shown on the display screen. If no breath is detected after warm up has ended, the No Breath Detected alarm will occur. Refer to Alarm Conditions in Troubleshooting.

4.7 Breathing with the Use of the Concentrator

As you breathe with the nasal cannula installed, a pulse of oxygen is delivered each time the concentrator senses an inhalation. Refer to Connecting/Positioning the Nasal Cannula in Setup for cannula installation instructions.

If no breath is detected for 15 seconds, the No Breath Detected alarm will occur. Refer to Alarm Conditions in Troubleshooting.

4.8 Reading the Display Screen

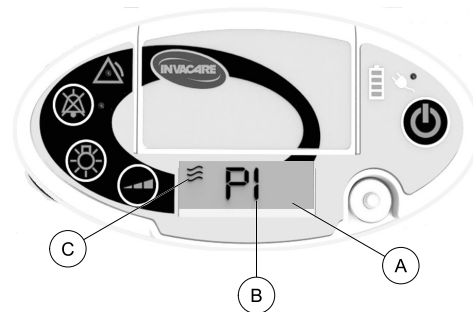

Pulse Flow Setting and Pulse Icon

After the concentrator finishes warming up, the current oxygen pulse flow setting (B) and pulse icon (C) are shown on the display screen (A).

The pulse icon flashes on each time an oxygen pulse is triggered.



The pulse flow setting and pulse icon are not shown when alarm text is displayed on screen.

Informational Text

Informational text is shown on the display screen during certain periods of concentrator operation:

- “Warming Up” — displayed while the concentrator is warming up after first being turned on.
- “Powering Down” — displayed while the concentrator is powering down after being turned off.

Alarm Text

If an alarm condition exists, text describing the alarm will be shown on the display screen.

Refer to Alarm Conditions in Troubleshooting for more detail on alarm conditions and related alarm text.

4.9 Adjusting the Pulse Flow Setting



CAUTION!

Risk of Minor Injury or Discomfort

It is very important to select the prescribed oxygen flow setting. This will ensure you will receive the therapeutic amount of oxygen according to your medical condition:

- DO NOT increase or decrease the flow setting unless a change has been prescribed by your physician or therapist.
- The therapeutic effectiveness of the prescribed oxygen flow setting should be periodically reassessed.
- Use only the length of cannula that was used to determine the prescribed oxygen flow setting.
- The pulse flow settings of this concentrator might not correspond to continuous flow oxygen.
- The settings of other models or brands of oxygen therapy equipment do not correspond to the settings of this concentrator.

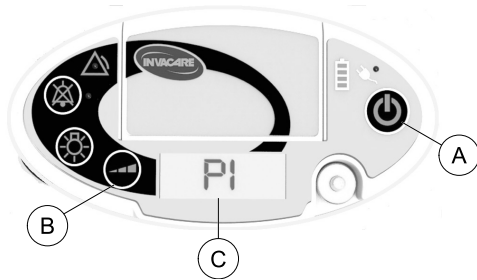

1. With the concentrator running, press the flow selection button **B** to increase the pulse flow setting by one increment.
2. Press the flow selection button additional times, as needed, until your prescribed flow setting (P1 to P4/P5) is shown on the display screen **C**.



Each time the flow setting is changed, an audible beep will occur and the display screen backlight will turn on for five seconds.

- POC1-100B Models: The concentrator has four pulse flow settings. When the maximum pulse flow setting P4 is reached, the pulse flow setting returns to setting P1 with the next button press.
- POC1-100C Models: The concentrator has five pulse flow settings. When the maximum pulse flow setting P5 is reached, the pulse flow setting returns to setting P1 with the next button press.



If a message other than the pulse flow setting is shown on the display screen, the adjusted pulse flow setting will temporarily be displayed for five seconds after pressing the flow selection button.



The concentrator pulse flow setting at power-up will be the same flow setting selected the last time the unit was turned off.

4.10 Battery Life and Management

Time away from home is greatly extended by combining the use of the AC power adapter, DC power cable and the concentrator's batteries. To ensure the battery(s) maintain their optimal charge level, utilize the AC power adapter whenever you have access to electric power. Utilize the DC power cable whenever you are in a vehicle.



CAUTION!

Risk of Minor Injury or Discomfort

Battery exhaustion will result in a loss of supplemental oxygen. To ensure proper supplemental oxygen delivery during a power outage:

- Plug your portable concentrator into an alternate power source.
- Have an alternate source of oxygen available that does not require a power source.

What to Do

- When you first receive your concentrator, fully charge the battery(s) overnight.

- Keep your battery(s) fully charged when using the concentrator on a daily basis.
- Your concentrator battery(s) can be recharged at any time.
- Always ensure the concentrator battery(s) are recharged as soon as possible after they become fully discharged. The battery(s) may be permanently degraded if left fully discharged for an extended length of time.
- Check the status of your concentrator battery(s) once a month if you are not using your concentrator on a daily basis. Battery(s) should be maintained at two illuminated bars worth of charge if not using the concentrator on a daily basis.
- Heat is the worst enemy of a battery. Allow plenty of air to circulate around the concentrator so that the battery(s) is kept as cool as possible when in use and when charging.
- DO NOT leave your battery(s) installed into the concentrator when the concentrator is not going to be used for more than a day. The battery(s) will lose charge while plugged into the concentrator even with the concentrator turned off.

What Not to Do

- DO NOT use or leave the concentrator or battery(s) in excessive heat or cold.
- DO NOT store or leave the concentrator or battery(s) in car trunks, etc. for extended periods of time.
- DO NOT store battery(s) fully charged (four bars illuminated on the unit's battery gauge) if you are going to store your concentrator for any time greater than a day. Recharge or discharge the battery to two bars (50% charge) only. Storing a battery with a full charge may degrade its useful life.

5 Maintenance

5.1 Maintenance



WARNING!

Risk of Injury or Damage

- Invacare oxygen concentrators are specifically designed to minimize routine preventive maintenance. To prevent injury or damage:
- Only professionals of the health care field or persons fully conversant with this process such as factory trained personnel should perform preventive maintenance or performance adjustments on the oxygen concentrator and its equipment, except for tasks described in this manual.
 - Users should contact your dealer or Invacare for service.

5.2 Service Life

The expected service life of this product, with the exception of wear components (see *6.3 Wear and Tear, page 48*), is three years of operation when used in accordance with the safety instructions, maintenance intervals and correct use stated in this manual. The effective service life can vary according to the frequency and intensity of use. Refer to the procedures in *5 Maintenance, page 41*.

Perform all maintenance according to the recommended schedule in this manual.

5.3 Cleaning the Cabinet



DANGER!

Risk of Injury or Damage

Liquid will damage the internal components of the concentrator and its equipment. To avoid damage or injury from electrical shock:

- Turn Off the concentrator and unplug the power cord before cleaning.
- DO NOT allow any cleaning agent to drip inside the air inlet and outlet openings.
- DO NOT spray or apply any cleaning agent directly to the cabinet.
- DO NOT hose down the product.



CAUTION!

Risk of Damage

Harsh chemical agents can damage the concentrator and its equipment. To avoid damage:

- DO NOT clean with alcohol and alcohol based products (isopropyl alcohol), concentrated chlorine-based products (ethylene chloride), and oil-based products (Pine-Sol®, Lestoil®) or any other harsh chemical agents. Only use mild liquid dish detergent (such as Dawn®).

Periodically clean the concentrator's cabinet as follows:

1. Turn off concentrator.
2. Remove the concentrator from the carry bag or back pack.
3. Use a damp cloth, or sponge, with a mild detergent such as Dawn dish washing soap to gently clean the exterior case.
4. Allow the concentrator to air dry, or use a dry towel, before returning the concentrator to the carry bag or back , and prior to operating the concentrator.
5. Return the concentrator to its carry bag or back pack.

 The AC power adapter and AC power cord are to be cleaned in a similar manner.

5.4 Cleaning the Air Intake Filter Screen



CAUTION! **Risk of Damage**

To avoid damage from clogging:
– Replace the carry bag if the air intake filter screen is torn or frayed.

 Clean the air intake filter screen at least once each week. The air intake filter screen is part of the carry bag.



1. Turn off concentrator.
2. Use a vacuum cleaner or nylon brush to clean dust/debris from air intake filter screen (A).

5.5 Cleaning the Carry Bag



CAUTION! **Risk of Damage**

To avoid damage to the product:
– DO NOT machine wash or dry the carry bag.



1. Turn off concentrator.
2. Remove the concentrator (A) from the carry bag (B).
3. Connect concentrator to an external power source.

4. Wipe or brush the carry bag with a mild liquid dish detergent (such as Dawn) and water. Rinse thoroughly.
5. Allow the carry bag to air dry after cleaning and before using.

5.6 Cleaning and Disinfection Between Patients

Cleaning and disinfection must be performed between patients and as necessary.



WARNING!

Risk of Injury or Damage

To prevent injury from infection or damage to concentrator:

- Only qualified personnel should perform cleaning and disinfection of the oxygen concentrator and accessories between patients.



Follow these instructions to eliminate possible pathogen exchange between patients due to contamination of components or accessories.

1. Dispose of and replace all patient side accessories not suitable for multiple patient use, including but not limited to: cannula and oxygen tubing.
2. Clean concentrator and accessories as described in Maintenance.

3. Disinfect the surfaces of the concentrator and accessories using Clorox® 4 in One Disinfectant & Sanitizer or substantially equivalent product.



WARNING!

Risk of Injury or Damage

- Follow the cleaning/disinfectant product manufacturer's instructions for use, handling, storage and disposal of the product.
- Use of inappropriate disinfecting products may degrade device materials and negatively affect device safety and performance.



If the accessories, such as the carry bag, are unable to be cleaned or disinfected, discard the accessory and replace.

4. Perform the tasks on Preventive Maintenance Checklist.
5. Before repackaging and distribution to new patient, ensure packaging contents contain the concentrator, battery, carry bag with shoulder straps, AC power adapter, AC power cord, DC power cable, labels and user manual.

5.7 Viewing Hour Meter

To view the elapsed hours of concentrator run time perform the following steps:

1. Ensure that the unit is powered off and connected to an external power source.
2. Press and hold the flow selection button for five seconds.



3. The cumulative hours of concentrator operation (compressor hours) will be shown on the display screen for as long as the button is continually pressed. The concentrator run time is displayed to the nearest 0.1 hours.
4. Release the flow selection button.

5.8 Preventative Maintenance Checklist

The following Preventative Maintenance Checklist contains maintenance tasks to be performed by the users of this product, except where otherwise noted. If you are unable to understand these tasks, contact your provider or a qualified technician.

REF

SN

WEEKLY							
Record Date of Service.							
Record Elapsed Hours on Hour Meter. (Refer to Viewing Hour Meter in Maintenance.)							
Clean Air Intake Filter Screen							
Inspect Cabinet of Concentrator and AC Adapter for Damage. Do not use if damage is found. Return to Invacare for repair.							
Inspect Carry Bag Strap(s) and hardware for Damage. Replace strap or carry bag if damage found.							
Inspect Electrical Cords for Damage. Replace Electrical Cord if damage is found.							
Check for presence and legibility of all Labels. Replace Labels as needed. Refer to Label Locations.							

REF

SN

EVERY 4,380 HOURS, EVERY 3 YEARS, AND BETWEEN PATIENTS, WHICHEVER COMES FIRST							
Check Oxygen Purity*							
Perform Functional Test*							
DURING PREVENTATIVE MAINTENANCE SCHEDULE AND BETWEEN PATIENTS							
Check Intake Filter Screen for damage. Replace carry bag if damage is found.							
Check/Replace Outlet Filter*							

Inspection periods shown as hours is in reference to hours of concentrator operation since the last date of service. Refer to Viewing Hour Meter in Maintenance. Inspection periods shown as months or years is in reference to duration of time since the last date of service.

*To be conducted by provider or qualified technician. Refer to service manual.

6 After Use

6.1 Storage

1. Remove battery(s) prior to storage.
2. Store the repackaged oxygen concentrator and battery(s) in a cool, dry area.
3. DO NOT place objects on top of packaged concentrator.

 Refer to storage conditions in Specifications in Technical Data.

 After removing from storage, it may take up to one hour at room temperature for the product to reach its operating temperature and be ready for use.

6.2 Disposal

Recycle



DO NOT dispose of in household waste



This product has been supplied from an environmentally aware manufacturer who complies with the Waste Electrical and Electronic Equipment (WEEE) Directive 2012/19/EC. This product may contain substances that could be harmful to the environment if disposed of in places (landfills) that are not appropriate according to legislation.

Follow local governing ordinances and recycling plans regarding disposal of the concentrator or components normally used in operation. The concentrator does not generate waste or residue in operation.

- DO NOT dispose of the concentrator in the normal waste stream.
- Any accessories not part of the concentrator MUST be handled in accordance with the individual product marking for disposal.
- DO NOT dispose of the internal or supplemental batteries. Batteries should be returned to your dealer/provider.

6.3 Wear and Tear

Invacare reserves the right to ask for any item back that has an alleged defect in workmanship. See Warranty that shipped with the product for specific warranty information.

Refer to Maintenance in this manual for proper preventative maintenance schedule and use of the product.

This is only a general guideline and does not include items damaged due to abuse and misuse.

Normal wear and tear items and components for this product are listed below.

Description	Expected Life
Compressor inlet filter	1,460 hours
Carry bag	18 months
Battery	18 months
Sieve bed assembly	1 year



Expected life values shown as hours is in reference to hours of concentrator operation. Refer to Viewing Hour Meter in Maintenance. Expected life values shown as months or years is in reference to duration of time since the date of purchase.



Sieve is a porous filtering material and is considered a wear item. Some factors that could affect sieve material life include humidity, temperature, particulates, air contaminates, air intake, vibration and other environmental conditions.

7 Troubleshooting

7.1 Troubleshooting

If your concentrator fails to operate properly, refer to the following chart for possible causes and solutions. If necessary, contact your provider.

Oxygen Concentrator Does Not Turn On or Does Not Stay On

Symptom	Probable Cause	Solution(s)
Concentrator does not operate when On/Off button is pressed. OR Concentrator begins to operate when On/Off button is pressed, but all LCD and front panel lights go dark.	On/Off button was not held down long enough.	Try to power up the concentrator again while continuing to press the On/Off button until the front panel lights and LCD begin to illuminate. This takes typically one full second.
	Battery is discharged (or improperly connected to the concentrator).	<ol style="list-style-type: none"> 1. Remove battery and check battery gauge. 2. If gauge shows battery is charged, then reinstall battery and retry. 3. If gauge shows battery is depleted, then either install a charged battery or connect external power and retry.
	Battery is improperly connected to the concentrator.	<ol style="list-style-type: none"> 1. Remove the battery and any external power connection. 2. Reinstall the battery, making sure it is completely inserted and retry. 3. Connect to either AC or DC external power and retry.
	Battery has performed a self-protect shutdown when there was no external power.	<ol style="list-style-type: none"> 1. Wait one minute and retry. 2. Change to an alternate battery or connect concentrator to either AC or DC external power and retry.

Concentrator is Beeping with No Lights or Display

Symptom	Probable Cause	Solution(s)
Concentrator is beeping with no lights or display.  Beeping will last less than two minutes if no power source is provided.	Battery has been removed or disconnected and there is no external power connected.	<ol style="list-style-type: none"> 1. Ensure the battery is completely inserted and restart. 2. Install a different charged battery and restart.
	When operating without a battery, external power is lost.	<ol style="list-style-type: none"> 1. Try another power outlet and check connections to concentrator and restart.

Battery Not Charging When External Power is Connected

Symptom	Probable Cause	Solution
With AC or DC power plugged into the concentrator, the external power icon is illuminated and battery charge level indicator is not flashing.	Power source is faulty, or there is a loose connection.	<ol style="list-style-type: none"> 1. Try another power outlet and check connections to concentrator.
	Battery is outside the allowed temperature range for charging.	<ol style="list-style-type: none"> 1. Allow concentrator and battery to cool down to less than 104°F (40°C), or warm up to 41°F (5°C).
	Battery is not fully seated.	<ol style="list-style-type: none"> 1. Ensure the battery is completely inserted.
	Battery charge is complete (all four segments of charge level indicator are illuminated).	<ol style="list-style-type: none"> 1. No action required.

No External Power Symbol Illuminated on Control Panel

Symptom	Probable Cause	Solution
With AC power plugged into concentrator, external power icon is not illuminated on the control panel.	Power source is faulty, or there is a loose connection.	<ol style="list-style-type: none"> 1. If the green indicator light on the AC adapter is lit, check power connections from the AC adapter to concentrator. 2. If the green indicator light on the AC adapter is not lit, check power connections from outlet to AC adapter or try another outlet.
With DC power plugged into concentrator, external power icon is not illuminated on the control panel.	Power source is faulty or there is a loose connection.	<ol style="list-style-type: none"> 1. Check power connections to concentrator. 2. Try another power outlet.
	The DC power cable fuse has blown.	<ol style="list-style-type: none"> 1. Switch to AC power and contact your provider to service the DC power cable.

7.2 Alarm Conditions



When any alarm condition occurs, the yellow alarm indicator light on the control panel illuminates and text describing the alarm condition is shown on the display screen. Refer to the solution section of the alarm tables for potential corrective actions. If necessary, contact your provider.

In all cases, pressing and holding the On/Off button for one second will turn off and reset the concentrator.

If the cause of the alarm condition is not corrected, it will reappear when the concentrator is turned back on.

All alarms are classified as Low Priority technical alarm conditions.

When multiple alarm conditions exist, the text associated with the highest ranked alarm will be shown on the display screen.

7.2.1 Operational Alarms

The concentrator continues to run when the alarm conditions listed in this section occur.

LCD DISPLAY TEXT:	DESCRIPTION:	SOLUTIONS:
No Breath Detected Check Cannula	Oxygen concentrator has not detected a breath over a 15 second period.	1. Verify cannula is connected, not kinked, properly positioned and user is breathing through his/her nose.
INDICATORS:		
Single audible beep every 30 seconds YELLOW alarm indicator illuminated		
NOTES:		
<p>Alarm will turn off when a breath is detected.</p> <p>This alarm does not apply during warm up.</p> <p>If no breath is detected for two minutes, the alarm will escalate to a shutdown alarm. Refer to Shutdown Alarms in Troubleshooting.</p> <p>The first occurrence of this alarm condition will cancel the audio off (mute) feature. Audio off (mute) can be reactivated. If reactivated, the alarm audio off (mute) feature will remain activated even if this alarm condition occurs again.</p>		
LCD DISPLAY TEXT:	DESCRIPTION:	SOLUTIONS:
Breath Rate High Reduce Activity	The user breath rate has exceeded the capacity of the concentrator for more than 15 seconds.	1. The user should immediately reduce his/her activity level to get his/her breath rate to slow down.
INDICATORS:		
Single audible beep every 30 seconds YELLOW alarm indicator illuminated		

LCD DISPLAY TEXT:	DESCRIPTION:	SOLUTIONS:
NOTES:		
<p>A sufficient reduction of the user's breath rate will automatically turn off the alarm.</p> <p>The first occurrence of this alarm condition will cancel the audio off (mute) feature. Audio off (mute) can be reactivated. If reactivated, the alarm audio off (mute) feature will remain activated even if this alarm condition occurs again.</p>		

LCD DISPLAY TEXT:	DESCRIPTION:	SOLUTIONS:
Low Battery Charge Concentrator	Remaining battery run time of approximately 30 minutes. Battery requires charging.	<ol style="list-style-type: none"> 1. Connect oxygen concentrator to either the AC or DC power or insert an alternate charged battery into the unit, OR 2. Insert an alternate charged battery into the unit. Remove the depleted battery and charge it with the external battery charger for future use.
INDICATORS: Single audible beep no repeat YELLOW alarm indicator illuminated Battery gauge: <ul style="list-style-type: none"> • Pulse Flow Settings P1–P3: only the lowest segment is illuminated • Pulse Flow Setting P4–P5: only the lowest two segments are illuminated 		
NOTES:		
<p>The alarm turns off when external power is connected or when a charged battery is installed.</p> <p>Alarm will turn off when a breath is detected.</p>		

LCD DISPLAY TEXT:	DESCRIPTION:	SOLUTIONS:
Low Battery Charge Now	Remaining battery run time of approximately 15 minutes or less. Battery requires charging.	<ol style="list-style-type: none"> 1. Connect oxygen concentrator to either the AC or DC power, OR 2. Insert an alternate charged battery into the unit. Remove the depleted battery and charge it with the external battery charger for future use, OR 3. If no other power source is available, change to another source of oxygen.
INDICATORS: Single audible beep every 30 seconds YELLOW alarm indicator illuminated Battery gauge: <ul style="list-style-type: none"> • Only the lowest segment is illuminated 	Loss of power is imminent.	

NOTES:

The alarm turns off when external power is connected or when a charged battery is installed.

The first occurrence of this alarm condition will cancel the audio off (mute) feature. Audio off (mute) can be reactivated. If reactivated, the alarm audio off (mute) feature will remain activated even if this alarm condition occurs again.

LCD DISPLAY TEXT:	DESCRIPTION:	SOLUTIONS:
Unit Hot Allow to cool	Concentrator is near its maximum operating temperature.	<ol style="list-style-type: none"> 1. Move concentrator to cooler surroundings. Allow concentrator to cool down to less than 104°F (40°C). 2. Clean intake filter screen.
INDICATORS: Single audible beep every 30 seconds YELLOW alarm indicator illuminated		

NOTES:

The alarm will turn off when the required internal operating temperature is reached.

LCD DISPLAY TEXT:	DESCRIPTION:	SOLUTIONS:
Unit Cold Allow to warm	Concentrator is near its minimum operating temperature.	1. Move concentrator to warmer surroundings. Allow concentrator to warm up to 41°F (5°C).
INDICATORS:		
Single audible beep every 30 seconds YELLOW alarm indicator illuminated		
NOTES:		
The alarm will turn off when the required internal operating temperature is reached.		

LCD DISPLAY TEXT:	DESCRIPTION:	SOLUTIONS:
Battery Hot Allow to cool	Battery is near its maximum operating temperature.	1. Move concentrator to cooler surroundings. Allow concentrator to cool down to less than 104°F (40°C), OR 2. Use AC or DC power and remove battery, OR 3. Insert an alternate charged battery and remove the hot battery.
INDICATORS:		
Single audible beep every 30 seconds YELLOW alarm indicator illuminated		
NOTES:		
The alarm will turn off when the required battery temperature is reached or if external power is connected and battery is removed.		

LCD DISPLAY TEXT:	DESCRIPTION:	SOLUTIONS:
Battery Cold Allow to warm	Battery is near its minimum operating temperature.	<ol style="list-style-type: none"> 1. Move concentrator to warmer surroundings. Allow concentrator to warm up to 41°F (5°C), OR 2. Use AC or DC power and remove battery, OR 3. Insert an alternate charged battery and remove the cold battery.
INDICATORS:		
Single audible beep every 30 seconds YELLOW alarm indicator illuminated		
NOTES:		
The alarm will turn off when the required internal operating temperature is reached or if external power is connected and battery is removed.		

LCD DISPLAY TEXT:	DESCRIPTION:	SOLUTIONS:
Low Oxygen See Manual	The oxygen output purity has fallen to a value between 73% and 87%.	<ol style="list-style-type: none"> 1. Verify concentrator is in recommended environmental temperature. Refer to Specifications in Technical Data. 2. Clean intake filter screen and ensure both intake and exhaust are not blocked. 3. Turn concentrator off, then on again to retry.
INDICATORS:		
Single audible beep every 30 seconds YELLOW alarm indicator illuminated		

LCD DISPLAY TEXT:	DESCRIPTION:	SOLUTIONS:
NOTES:		
<p>The alarm will turn on when the oxygen purity has dropped below 85%.</p> <p>The alarm will turn off when the oxygen output purity has increased above to 87%.</p> <p>The alarm limits have a tolerance of +/- 2%.</p> <p>Alarm signal generation may be delayed by up to 128 seconds due to the monitoring algorithm used to prevent nuisance alarms.</p> <p>Call your provider and report the problem if the warning continues with next use.</p>		

LCD DISPLAY TEXT:	DESCRIPTION:	SOLUTIONS:
<p>Cannot charge Allow to cool</p>	<p>Battery is too hot to allow the battery to charge.</p>	<ol style="list-style-type: none"> 1. Move concentrator to cooler surroundings. Allow concentrator to cool down to less than 104°F (40°C), OR 2. Remove battery (with AC or DC power connected) to allow battery to cool.
<p>INDICATORS:</p> <p>Single audible beep every 30 seconds YELLOW alarm indicator illuminated</p>	<p>This alarm only occurs when External Power is connected.</p>	
NOTES:		
<p>The alarm will turn off when the required battery temperature is reached, when the battery is removed, or when external power is disconnected.</p>		

LCD DISPLAY TEXT:	DESCRIPTION:	SOLUTIONS:
Cannot charge Allow to warm	Battery is too cold to allow the battery to charge.	<ol style="list-style-type: none"> 1. Move concentrator to warmer surroundings. Allow concentrator to warm up to 41°F (5°C), OR 2. Remove battery (with AC or DC power connected) to allow battery to warm.
INDICATORS:	This alarm only occurs when an external power source is connected.	
Single audible beep every 30 seconds YELLOW alarm indicator illuminated		
NOTES:		
The alarm will turn off when the required battery temperature is reached, when the battery is removed, or when external power is disconnected.		

LCD DISPLAY TEXT:	DESCRIPTION:	SOLUTIONS:
Sensor Fault See Manual	Oxygen sensor feedback is out-of-range. Sensor failure is likely.	<ol style="list-style-type: none"> 1. Turn concentrator Off, then On again to retry.
INDICATORS:		
Single audible beep every 30 seconds YELLOW alarm indicator illuminated		
NOTES:		
The alarm will turn off when the sensor feedback is back in range.		
Call your provider and report the problem if alarm continues.		

LCD DISPLAY TEXT:	DESCRIPTION:	SOLUTIONS:
Warming Up	The concentrator is still warming up after two minutes from initial start up. The oxygen output purity has not reached the minimum value listed in Specifications in Technical Data.	<ol style="list-style-type: none"> 1. Verify concentrator is in recommended environmental temperature. Refer to Specifications in Technical Data. 2. Clean intake filter screen and ensure both intake and exhaust are not blocked. 3. Allow concentrator to continue warming up for at least 15 minutes. 4. Turn concentrator off, then on again to retry.
INDICATORS:		
No audible beep YELLOW alarm indicator illuminated		
NOTES:		
<p>Depending on a variety of factors, it can take up to 15 minutes to reach the minimum specified oxygen purity.</p> <p>The alarm will turn off when the minimum oxygen output purity is reached.</p> <p>If the minimum oxygen output purity has not been reached within 15 minutes from initial start up, the alarm will become a Low Purity alarm condition.</p>		

7.2.2 Shut Down Alarms

The concentrator shuts down when the alarm conditions in this section occur.

LCD DISPLAY TEXT:	DESCRIPTION:	SOLUTIONS:
Shut Down No Breath Detected	Oxygen concentrator has not detected a breath for over a two minute period.	<ol style="list-style-type: none"> 1. Verify cannula is connected, not kinked, properly positioned and user is breathing through his/her nose. 2. Change to another source of oxygen if alarm continues.
NOTES:		
<p>This alarm does not apply during warm up.</p> <p>To clear alarm, turn the concentrator off. Complete solution 1 before restarting. Press and hold the On/Off button to power down the concentrator and restart.</p>		
LCD DISPLAY TEXT:	DESCRIPTION:	SOLUTIONS:
Shut Down Stuck button	A stuck button is detected upon connection to power source.	<ol style="list-style-type: none"> 1. Remove all power sources from concentrator. Press each control button looking for a stuck button. Reconnect power. 2. Change to another source of oxygen if alarm continues.
INDICATORS: Two audible beeps every 16 seconds YELLOW alarm indicator illuminated		
NOTES:		
<p>To clear alarm, turn the concentrator off. Complete solution 1 before restarting. Call your provider and report the problem if alarm continues.</p>		

LCD DISPLAY TEXT:	DESCRIPTION:	SOLUTIONS:
Shut Down Battery Depleted	Remaining battery capacity has been completely used. Battery requires charging.	<ol style="list-style-type: none"> 1. Connect oxygen concentrator to either the AC or DC power, OR 2. Insert an alternate charged battery. Remove the depleted battery and charge with the optional external battery charger accessory for future use, OR 3. If no other power source is available, change to another source of oxygen.
INDICATORS:	Concentrator function has shut down.	
Two audible beeps every 16 seconds YELLOW alarm indicator illuminated Battery gauge: <ul style="list-style-type: none"> • No segments illuminated 		
NOTES:		
To clear the alarm, the concentrator needs to be turned off. Complete solution 1 or 2 before restarting.		

LCD DISPLAY TEXT:	DESCRIPTION:	SOLUTIONS:
Shut Down Unit Too Hot	Concentrator is too hot to allow it to continue operating.	<ol style="list-style-type: none"> 1. Move concentrator to cooler surroundings. Allow concentrator to cool down to 104°F (40°C). 2. Use AC or DC adapter for power. 3. Clean intake filter screen. 4. Change to another source of oxygen while waiting.
INDICATORS:	Concentrator function has shut down.	
Two audible beeps every 16 seconds YELLOW alarm indicator illuminated	Internal fan will continue to run to help lower internal temperature.	
NOTES:		
To clear the alarm, turn the concentrator off. Complete solutions 1, 2, and/or 3 before restarting.		

LCD DISPLAY TEXT:	DESCRIPTION:	SOLUTIONS:
Shut Down Unit Too Cold	Concentrator is too cold to allow it to continue operating.	<ol style="list-style-type: none"> 1. Move concentrator to warmer surroundings. Allow concentrator to warm up to 41°F (5°C). 2. Use AC or DC adapter for power. 3. Change to another source of oxygen while waiting.
INDICATORS:	Concentrator function has shut down.	
Two audible beeps every 16 seconds YELLOW alarm indicator illuminated	Internal fan will continue to run to help increase internal temperature.	
NOTES:		
To clear the alarm, turn the concentrator off. Complete solutions 1, 2, and/or 3 before restarting.		

LCD DISPLAY TEXT:	DESCRIPTION:	SOLUTIONS:
Shut Down Battery Too Hot	Battery is too hot to allow the battery to continue operating.	<ol style="list-style-type: none"> 1. Move concentrator to cooler surroundings. Allow concentrator to cool down to less than 104°F (40°C), OR 2. Use AC or DC power and remove battery, OR 3. Insert an alternate charged battery and remove the hot battery, OR 4. Change to another source of oxygen if no other power source is available.
INDICATORS:	Concentrator function has shut down.	
Two audible beeps every 16 seconds YELLOW alarm indicator illuminated		
NOTES:		
To clear the alarm, turn the concentrator off. Complete solutions 1, 2, 3, or 4 before restarting.		

LCD DISPLAY TEXT:	DESCRIPTION:	SOLUTIONS:
Shut Down Battery Cold	Battery is too cold to allow the battery to continue operating.	<ol style="list-style-type: none"> 1. Move concentrator to warmer surroundings. Allow concentrator to warm up to 41°F (5°C), OR 2. Use AC or DC power and remove battery, OR 3. Insert an alternate charged battery and remove the cold battery, OR 4. Change to another source of oxygen if no other power source is available.
INDICATORS:	Concentrator function has shut down.	
Two audible beeps every 16 seconds YELLOW alarm indicator illuminated		
NOTES:		
To clear the alarm, turn the concentrator off. Complete solutions 1, 2, 3, or 4 before restarting.		

LCD DISPLAY TEXT:	DESCRIPTION:	SOLUTIONS:
Shut Down Oxygen Fault	The oxygen output purity has fallen to a value below 73%.	<ol style="list-style-type: none"> 1. Verify concentrator is in recommended environmental temperature. Refer to Specifications in Technical Data. 2. Clean intake filter and ensure both intake and exhaust are not blocked. 3. Change to another source of oxygen if alarm continues.
INDICATORS:	Concentrator function has shut down.	
Two audible beeps every 16 seconds YELLOW alarm indicator illuminated		
NOTES:		
To clear the alarm, turn the concentrator off. Complete Solution 1 and/or 2 before restarting. The alarm limit has a tolerance of +/- 2%		
Alarm signal generation may be delayed by up to 128 seconds due to the monitoring algorithm used to prevent nuisance alarms.		
Call your provider and report the problem if alarm continues.		

LCD DISPLAY TEXT:	DESCRIPTION:	SOLUTIONS:
Shut Down System Fault	Abnormal system condition has been detected.	<ol style="list-style-type: none"> 1. Turn the concentrator Off, then On again to retry. 2. Change to another source of oxygen if alarm continues
INDICATORS:	May be caused by malfunction of compressor, fan, pressure or software.	
Two audible beeps every 16 seconds YELLOW alarm indicator illuminated	Concentrator function has shut down.	
NOTES:		
<p>To clear the alarm, turn the concentrator off. Restart concentrator.</p> <p>Call your provider and report the problem if alarm continues.</p>		

LCD DISPLAY TEXT:	DESCRIPTION:	SOLUTIONS:
Not applicable. All power lost, display is blank.	All power sources have been lost/removed.	<ol style="list-style-type: none"> 1. Ensure the battery is completely inserted. 2. Check external power connections to the concentrator and to the power outlet. 3. Try another power outlet. 4. Change to another source of oxygen if alarm continues.
INDICATORS:	Concentrator function has shut down.	
Audible beeps every second for approximately 30 to 60 seconds No other control panel indicators illuminated		
NOTES:		
<p>This alarm occurs even if the concentrator is off when all power is removed.</p> <p>To clear the alarm, complete solutions 1, 2, or 3 before restarting.</p>		

8 Technical Data

8.1 Technical Description

The Invacare Platinum Mobile uses a molecular sieve and pressure swing adsorption methodology to produce the oxygen gas output. Ambient air enters the device, is filtered and then compressed. This compressed air is then directed into a nitrogen adsorbing sieve bed. Concentrated oxygen exits the opposite end of the sieve bed and is directed into an oxygen reservoir from which it is delivered to the patient.

The oxygen purity level of the output gas ranges from 87% to 95.6%. The oxygen is delivered to the patient through the use of a nasal cannula. A pulse dose delivery method is used. The concentrator detects the start of patient inhalation and delivers a measured pulse of oxygen. No further oxygen is delivered until the next patient inhalation is detected. The volume of oxygen delivered each minute is a fixed amount based on the selected pulse flow setting. The volume of each oxygen pulse will vary with the patient's breath rate such that the fixed minute volume is maintained.

The Invacare Platinum Mobile is capable of operation by the patient in a home, institution, vehicle, or other environments outside the home. Device standard power options include an AC to DC switching power adapter operating from an AC power outlet (100–240VAC, 50–60 Hertz nominal), a DC power cable operating from an accessory outlet typically found in a vehicle type environment (12 VDC nominal), and up to two rechargeable batteries.

No specific product knowledge or training is required to operate the product other than what is contained in this manual.

Service information will be available on request to qualified technical personnel ONLY.

8.1.1 Pneumatic Diagram

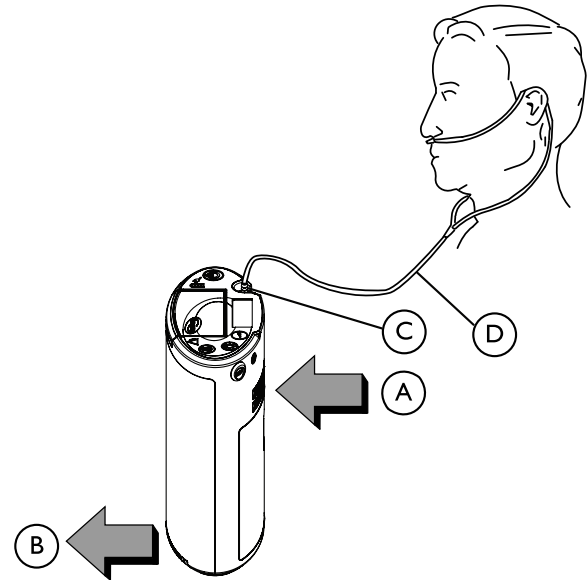

- (A) = Room Air In
- (B) = Exhaust Air Out
- (C) = Patient Outlet Fitting
- (D) = Nasal Cannula

8.2 Specifications

Electrical Requirements:	AC Power Supply: 110–240 VAC, 50–60 Hz DC Power Supply: 11–16 VDC
Rated Current Input:	5 A at 19 VDC, 10 A at 11–16 VDC
Power Consumption: (Typical)	Pulse Setting: P1 = 18 W P2 = 24 W P3 = 35 W P4–P5 = 45 W  Data is for concentrator operation only (no battery charging) utilizing an AC power source.
Operating Environmental Conditions: (All power sources)	Operating Temperature: 41°F to 104°F (5°C to 40°C) Relative Humidity: 15–90% non-condensing relative humidity, water vapor pressures up to 1.48 in Hg (50 hPa)
Storage and Transport Temperatures:	-13°F to 140°F (-25°C to 60°C)
Storage and Transport Humidity:	Up to 90% non-condensing relative humidity for temperatures of 41°F to 95°F (5°C to 35°C) Water vapor pressure up to 1.48 in Hg (50 hPa) for temperatures greater than 95°F (35°C)
Operating Altitude:	Up to 10,000 ft (3048 m) above sea level
Operating Atmospheric Pressure:	697–1060 hPa

Oxygen Purity:	87% to 95.6%, at all flow settings and over the rated ranges for ambient temperature, humidity and atmospheric pressure. After initial warm-up period (typically less than 5 minutes)
Conserver Trigger Sensitivity:	≤ 0.18 cmH ₂ O pressure drop (For all cannula lengths) Factory set—no adjustment, pressure activated Only patient respiratory efforts that achieve the trigger pressure will result in the delivery of an oxygen bolus.
Conserver Breath Rate Capacity:	15–40 BPM (breaths per minute) without reduction of bolus minute volume
Maximum Outlet Pressure:	28.5 psig (197 kPa)
Cannula Requirements:	Length: 4–25 ft (1.2–7.6 m) including all oxygen tubing Tubing: crush-proof, single lumen Adult, standard flow (rated for up to 6 L/min continuous flow) for lengths up to 7 ft) Adult, high flow (rated for up to 15 L/min continuous flow) for lengths greater than 7 ft to 25 ft) Example of Possible Cannula Model: Westmed Inc. Part Number 0194 (4 ft length)
Battery Specifications (each battery):	Rechargeable lithium-ion, 14.4 V, 5800 mAh, 83.5 Wh, 500 full charge/discharge cycle life
Battery Shelf Life:	12 months from date of manufacture

Battery Duration: (Times are approximate)	Condition	One Battery	Two Batteries
	Pulse Setting P1	5 hr 5 min	10 hr 10 min
	Pulse Setting P2	3 hr 30 min	7 hr 0 min
	Pulse Setting P3	2 hr 20 min	4 hr 40 min
	Pulse Setting P4–P5	1 hr 45 min	3 hr 30 min
Battery Charge Time: (Times are approximate)	Condition	One Battery	Two Batteries
	Concentrator On, Pulse Setting P1	2 hr 20 min	4 hr 40 min
	Concentrator On, Pulse Setting P2	2 hr 20 min	4 hr 40 min
	Concentrator On, Pulse Setting P3	2 hr 30 min	5 hr 0 min
	Concentrator On, Pulse Setting P4–P5	3 hr 10 min	6 hr 20 min
	Concentrator Off	2 hr 20 min	4 hr 40 min
Sound Pressure Level:	<p>≤ 40 dBA weighted for flow setting P2 (Tested per ISO 3744:2010 with microphone location as specified in ISO 8359:1996 subclause 4.6)</p> <p>≤ 65 dBA weighted for flow setting P4–P5 (Tested per ISO 80601–2–69 subclause 201.9.6.2.1.101)</p>		
Sound Power Level:	≤ 65 dBA weighted for flow setting P4–P5 (Tested per ISO 80601–2–69 subclause 201.9.6.2.1.101)		
Audible Signal Sound Pressure Level:	55 dBA +/- 5 dBA		
Dimensions:	9.4 in high x 7.4 in wide x 3.7 in deep (23.9 cm high x 18.8 cm wide x 9.4 cm deep)		
Weight: (Nominal)	<p>4.9 lbs (2.18 kg) with single battery and no carry bag</p> <ul style="list-style-type: none"> • Add 0.75 lbs (0.34 kg) for carry bag • Add 1.0 lbs (0.45 kg) for a second battery 		

Shipping Weight: (Nominal)	10.5 lbs (4.8 kg)
Classifications:	Class II Electrical Shock Protection, Type BF Applied Part, Continuous Operation
Ingress Protection Rating:	Concentrator—IP22 AC Power Adapter—IP21 Battery—Keep Dry
Applied Parts:	Cannula/Oxygen Tubing, Oxygen Outlet Port, Carry Bag

Delivered Oxygen Pulse Volumes:

- The nominal pulse volumes published in the following table is in milliliters at STPD (standard temperature and pressure dry) conditions and apply over the rated ranges for ambient temperature, humidity, and atmospheric pressure.
- Maximum variation from nominal: +/- 15%

4 ft to 25 ft Cannula/Oxygen Tubing Lengths						
	Breaths Per Minute					
	15	20	25	30	35	40
Pulse Setting = P1	14.7	11.0	8.8	7.3	6.3	5.5
Pulse Setting = P2	29.3	22.0	17.6	14.7	12.6	11.0
Pulse Setting = P3	44.0	33.0	26.4	22.0	18.9	16.5
Pulse Setting = P4	58.7	44.0	35.2	29.3	25.1	22.0
Pulse Setting = P5	66.7	50.0	40.0	33.3	28.6	25.0

8.3 Regulatory Listing

ETL certified complying with:	EN/IEC 60601-1; Ed: 3.1 EN/IEC 60601-1-2; Ed: 4 AAMI ES60601-1 (United States) CSA 22.2 No. 60601-1 (Canada) ISO 80601-2-69 ISO 80601-2-67 IEC 60601-1-6 IEC 60601-1-8 IEC 60601-1-11 RTCA DO 160G
-------------------------------------	---

8.4 Electromagnetic Compliance (EMC)

Guidance and manufacturer’s declaration—electromagnetic emission

The Device is intended for use in the electromagnetic environment specified below. The customer or the user of the Device should assure that it is used in such an environment.

Emissions test	Compliance	Electromagnetic environment - guidance
RF emissions CISPR 11	Group I	The Device uses RF energy only for its internal function. Therefore, its RF emissions are very low and are not likely to cause any interference in nearby electronic equipment.
RF emissions CISPR 11	Class B	The Device is suitable for use in all establishments including domestic establishments and those directly connected to the public low-voltage power supply network that supplies buildings used for domestic purposes.
Harmonic emissions IEC 61000-3-2	Class A	
Voltage fluctuations / flicker emissions IEC 61000-3-3	Complies	

Guidance and manufacturer’s declaration—electromagnetic immunity

The Device is intended for use in the electromagnetic environment specified below. The customer or the user of the Device should assure that it is used in such an environment.

Immunity test	IEC 60601 test level	Compliance level	Electromagnetic environment – guidance
Electrostatic discharge (ESD) IEC 61000-4-2	± 8 kV contact ± 15 kV air	± 8 kV contact ± 15 kV air	Floors should be wood, concrete or ceramic tile. If floors are covered with synthetic material, the relative humidity should be at least 30%.

Electrical Fast transient / burst IEC 61000-4-4	± 2 kV for power supply lines ± 1 kV for input/output lines	± 2 kV for power supply lines ± 1 kV for input/output lines	Mains power quality should be that of a typical commercial or hospital environment.
Surge IEC 61000-4-5	± 1 kV line(s) to line(s) ± 2 kV line(s) to ground	± 1 kV line(s) to line(s) ± 2 kV line(s) to ground	Mains power quality should be that of a typical commercial or hospital environment.
Voltage dips IEC 61000-4-11	0% U_T ; 1 cycle and 70% U_T ; 25/30 cycles Single phase: at 0°	0% U_T ; 1 cycle and 70% U_T ; 25/30 cycles Single phase: at 0°	Mains power quality should be that of a typical commercial or hospital environment. If the user of the Device requires continued operation during power mains interruptions, it is recommended that the Device be powered from an un-interruptible power supply or a battery. U_T is the a. c. mains voltage prior to application of the test level.
Voltage Interruptions IEC 61000-4-11	0% U_T ; 250/300 cycle	0% U_T ; 250/300 cycle	Mains power quality should be that of a typical commercial or hospital environment. If the user of the Device requires continued operation during power mains interruptions, it is recommended that the Device be powered from an un-interruptible power supply or a battery. U_T is the a. c. mains voltage prior to application of the test level.
Power frequency (50/60 Hz) magnetic field IEC 61000-4-8	30 A/m	30 A/m	Power frequency magnetic fields should be at levels characteristic of a typical location in a typical commercial or hospital environment.

<p>Conducted RF IEC 61000-4-6</p> <p>Radiated RF IEC 61000-4-3</p>	<p>3 V</p> <p>10 V/m</p>	<p>3 V</p> <p>10 V/m</p>	<p>Portable and mobile RF communications equipment should be used no closer to any part of the Device including cables, than the recommended separation distance calculated from the equation applicable to the frequency of the transmitter.</p> <p>Recommended separation distance:</p> <p>$d = 1.2\sqrt{P}$ 150 kHz to 80 MHz</p> <p>$d = 0.35\sqrt{P}$ 80 MHz to 800 MHz</p> <p>$d = 0.7\sqrt{P}$ 800 MHz to 2,5 GHz</p> <p>where P is the maximum output power rating of the transmitter in watts (W) according to the transmitter manufacturer and d is the recommended separation distance in metres (m).</p> <p>Field strengths from fixed RF transmitters, as determined by an electromagnetic site survey,^a should be less than the compliance level in each frequency range.^b</p> <p>Interference may occur in the vicinity of equipment marked with the following symbol:</p> <div style="text-align: center;">  </div>
--	--------------------------	--------------------------	--

^a Field strengths from fixed transmitters, such as base stations for radio (cellular/cordless) telephones and land mobile radios, amateur radio, AM and FM radio broadcast and TV broadcast cannot be predicted theoretically with accuracy. To assess

the electromagnetic environment due to fixed RF transmitters, an electromagnetic site survey should be considered. If the measured field strength in the location in which the Device is used exceeds the applicable RF compliance level above, the Device should be observed to verify normal operation. If abnormal performance is observed, additional measures may be necessary, such as reorienting or relocating the Device.

^b Over the frequency range 150 kHz to 80 MHz, field strengths should be less than [V1] V/m.

At 80 MHz and 800 MHz, the higher frequency range applies.

Recommended separation distances between portable and mobile RF communications equipment and the Device

The Device is intended for use in an electromagnetic environment in which radiated RF disturbances are controlled. The customer or the user of the Device can help prevent electromagnetic interference by maintaining a minimum distance between portable and mobile RF communications equipment (transmitters) and the Device as recommended below, according to the maximum output power of the communications equipment

Rated maximum output of transmitter [W]	Separation distance according to frequency of transmitter [m]		
	150 kHz to 80 MHz $d = 1.2\sqrt{P}$	80 MHz to 800 MHz $d = 0.35\sqrt{P}$	800 MHz to 2,5 GHz $d = 0.7\sqrt{P}$
0.01	0.12	0.04	0.07
0.1	0.37	0.11	0.22
1	1.17	0.35	0.70
10	3.69	1.11	2.21
100	11.67	3.50	7.00

For transmitters rated at a maximum output power not listed above the recommended separation, distance d in meters (m) can be estimated using the equation applicable to the frequency of the transmitter, where P is the maximum output power rating of the transmitter in watts (W) according to the transmitter manufacturer.

At 80 MHz and 800 MHz, the separation distance for the higher frequency range applies.



These guidelines may not apply in all situations. Electromagnetic propagation is affected by absorption and reflection from structures, objects and people.

9 Warranty

9.1 Limited Warranty

Refer to the warranty information included with your product for warranty details.

Invacare Corporation

USA

One Invacare Way
Elyria, Ohio USA
44035
440-329-6000
800-333-6900
Technical Services
440-329-6593
800-832-4707
www.invacare.com



Manufacturer

Invacare Corporation
2101 E. Lake Mary Blvd.
Sanford, FL USA 32773
407-321-5630



1194969-C 2018-10-09



Making Life's Experiences Possible®



Yes, you can.®