

Music is Fun!

Grade 5

Written by Linda Ann Hopley
Illustrated by S&S Learning Materials

About the author:

Linda Ann Hopley has been a piano and theory teacher for over 30 years. She has written material for music for the last ten years. She loves working with children and helping them to develop an interest and appreciation for music.

Copyright © 2010

This publication may be reproduced under licence from Access Copyright, or with the express written permission of On The Mark Press / S&S Learning Materials, or as permitted by law.

All rights are otherwise reserved, and no part of this publication may be reproduced, stored in a retrieval system, or transmitted in any form or by any means, electronic, mechanical, photocopying, scanning, recording or otherwise, except as specifically authorized. "We acknowledge the financial support of the Government of Canada through the Book Publishing Industry Development Program (BPIDP) for this project."

All Rights Reserved
Printed in Canada

Published in the United States by:
On the Mark Press
P.O. Box 433
Clayton, New York
13624
www.onthemarkpress.com

ISBN: 9781770781627 

Published in Canada by:
S&S Learning Materials
15 Dairy Avenue
Napanee, Ontario
K7R 1M4
www.sslearning.com

At Glance

Learning Expectations	The Keyboard Instruments	1, 2, 3, 4 Beat Notes and Rests	Names of 1, 2, 3 & 4 Beat Notes and Rests	The Staff, Bar Lines, Double Bar Lines	One Bar or Measure & Repeat Signs	Tied Notes	Soprano, Treble, Alto, Tenor, Bass & Pitch	The Brace	Time Signature	Key Signature	The Composer Tchaikovsky	Sharps, Flats, and Naturals	A B C D E F G and Do to Do Singing	Music Reviews and Games
Understanding Concepts														
• Learning about a composer.											•			•
• Recognizing the keyboard.	•												•	•
• Understanding note and rest values.		•	•		•	•			•					•
• Recognizing high and low pitch.							•							•
• Learning the singing and note scale.	•												•	•
• Recognizing the staff and its components.			•	•	•	•		•	•	•		•		•
• Learning the difference between time signature and key signature.									•	•				•
• Learning the difference between sharps, flats, and naturals.											•			•
Skills of Inquiry, Design, and Communication														
• Creativity	•	•	•	•	•	•	•	•	•	•	•	•	•	•
• Adding, counting, multiplying, and subtracting.		•							•					•
• Discovering how to play a keyboard and tap a rhythm.	•	•								•				
• Working with a group.	•	----- optional -----										•	•	
• Relating music to the outside world.											•			•

Table of Contents







At A Glance™	2
Teacher Assessment Rubric	4
Student Self-Assessment Rubric	5
Introduction	6
Materials List	7
Teacher Suggestions	8
Music Glossary	9
Teacher Notes - Music Incentives	13
Teacher Notes - Notes, Rests, Music Signs of the Staff and Keyboard, and Stencils	14
Musical Display Sheets	15
Worksheets on Notes and Beats	17
Rhythm Exercise to Play	21
Worksheets on Music Signs	22
A Song on the Keyboard	29
Stencils	30
Teacher Notes - The Keyboard Instrument, The Two Scales, The Composer Tchaikovsky, and Holiday Worksheets	31
A Music Story - Double Time at the Fair	32
The Glass Concert	35
Worksheet Fill-in	36
A Song on Do, Re, Mi and A, B, C	37
Worksheet on Pitch and Clefs	38
The Composer Tchaikovsky and Me	39
Holiday Worksheets	43
Teacher Instructions for the Games	47
Game Cards	49
Teacher Notes - Review Worksheets, Quiz, and Review Art	58
Review Worksheets	59
Review Quiz	61
Review Art	62
Certificates	63
Answer Sheet	64

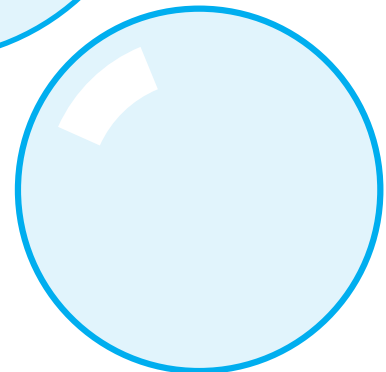
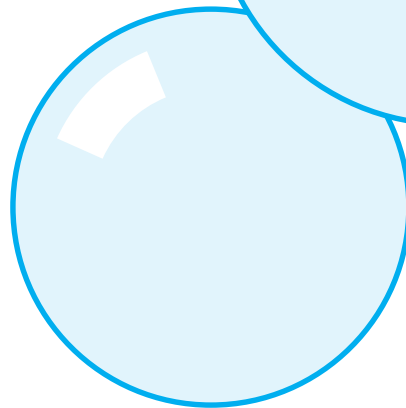
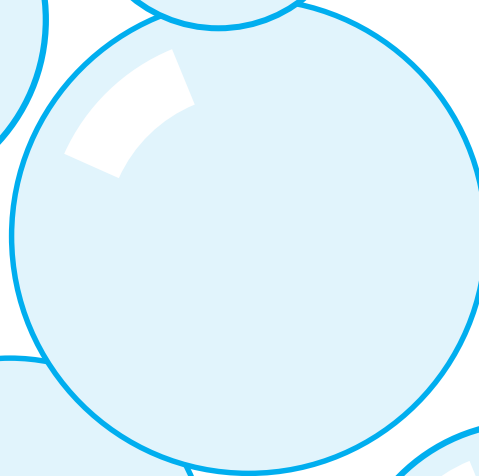
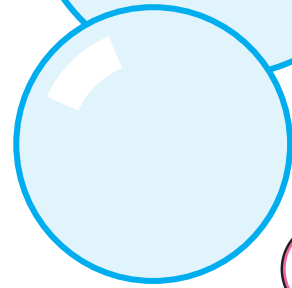
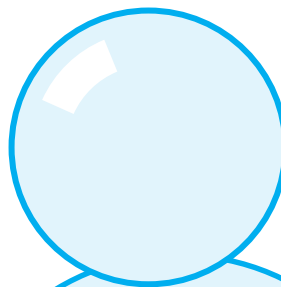
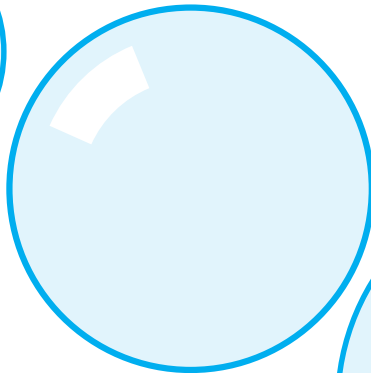
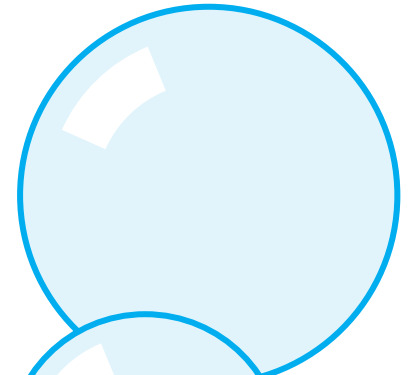
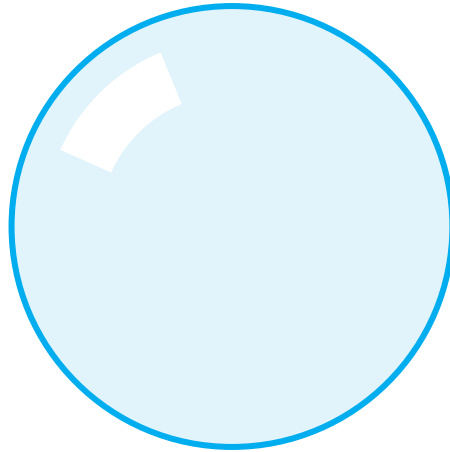
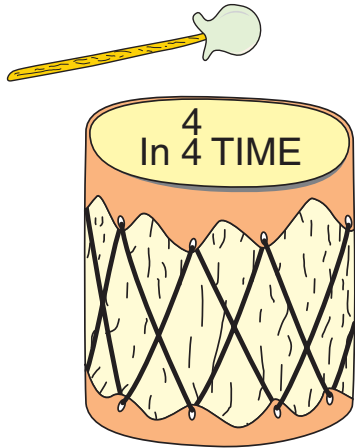

Musical Beats

Fill each bubble with 10 beats using the notes and rests.



-  = 1 BEAT
-  = 2 BEATS
-  = 3 BEATS
-  = 4 BEATS
-  = 4 BEATS
-  = 2 BEATS
-  = 1 BEAT

Notes to Note in $\frac{3}{4}$ time $\text{—} = 3$ beats

$\text{♪} \times \text{♪} = \underline{\hspace{2cm}}$

$\text{—} \times \text{—} \times \text{♪} = \underline{\hspace{2cm}}$

$\text{♪} + \text{♪} - \text{○} = \underline{\hspace{2cm}}$

$\text{♪} \times \text{♪} - \text{♪} = \underline{\hspace{2cm}}$

$\text{♪} \times \text{—} = \underline{\hspace{2cm}}$

$\text{—} + \text{—} + \text{—} = \underline{\hspace{2cm}}$

$\text{♪} + \text{♪} + \text{♪} + \text{♪} - \text{—} = \underline{\hspace{2cm}}$

$\text{—} \times \text{♪} = \underline{\hspace{2cm}}$

$\text{—} \times \text{○} = \underline{\hspace{2cm}}$

$\text{○} - \text{♪} + \text{♪} = \underline{\hspace{2cm}}$

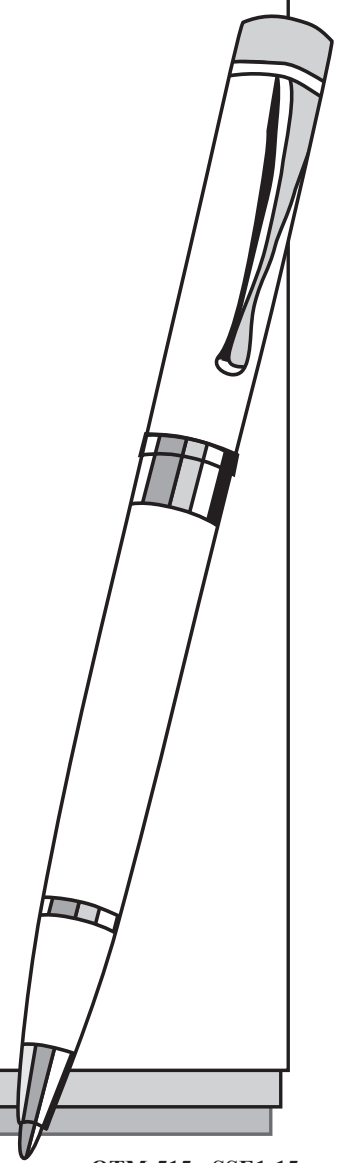

Two Rests

Trace the broken lines. Color the rests and finish the picture.

HALF
HAT

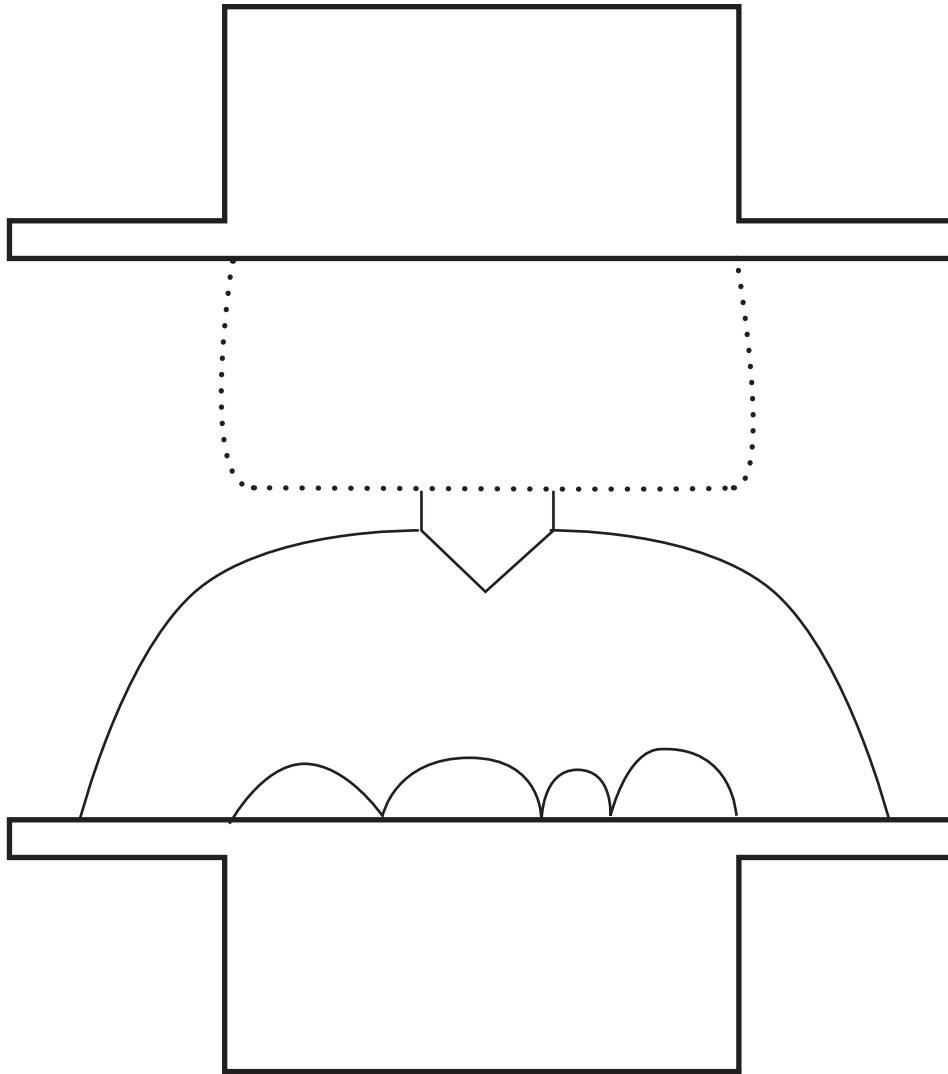

BOWL
WHOLE

