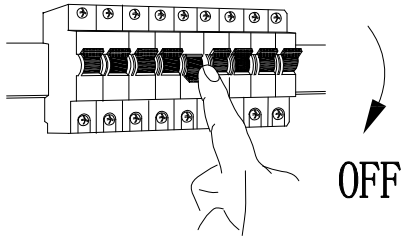
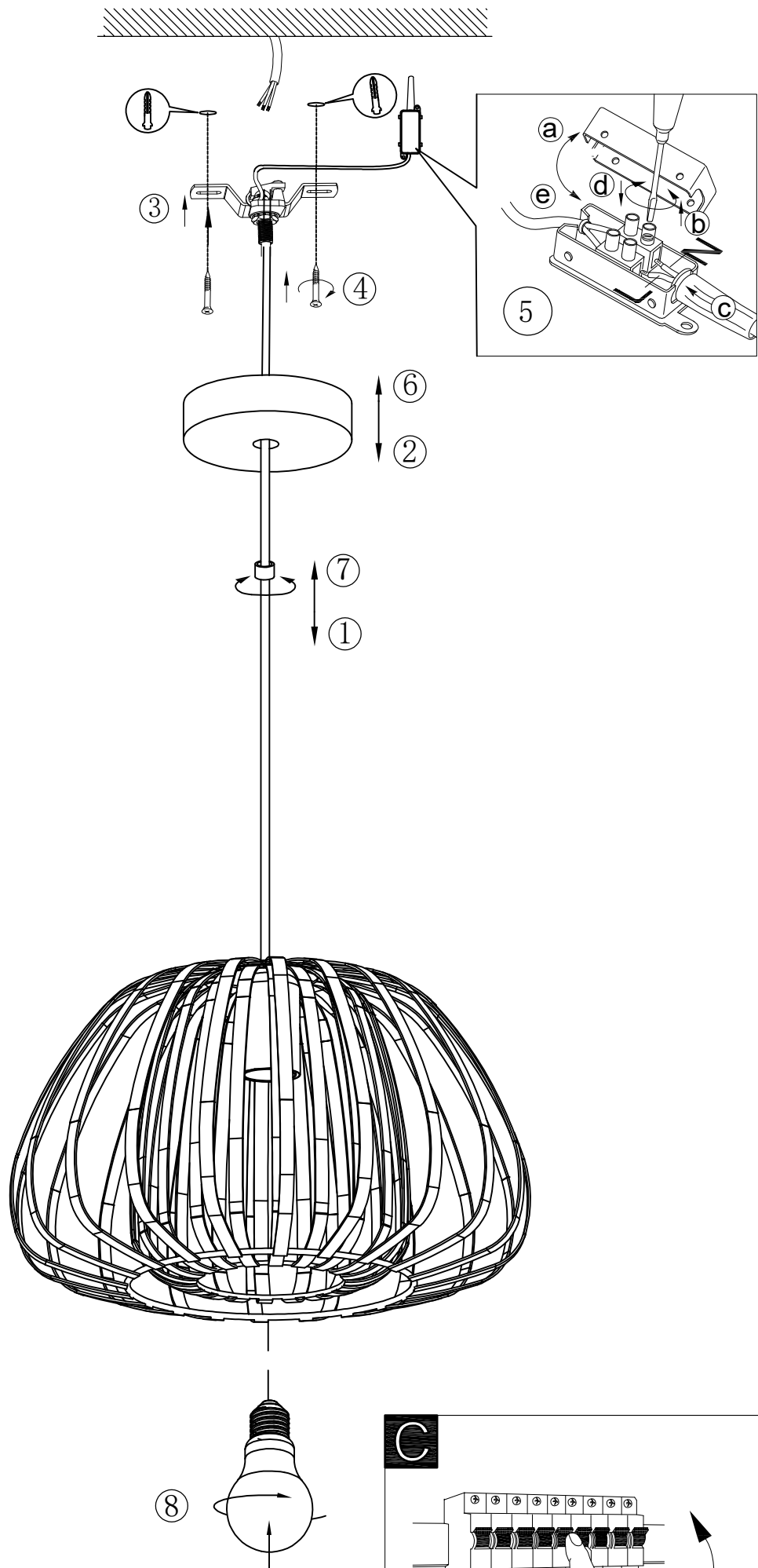
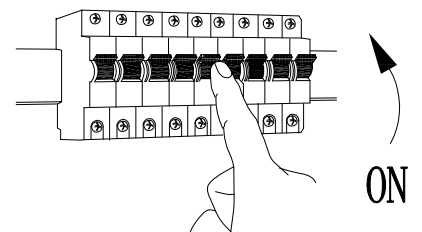

A**B****C**

BLA99666
www.eglo.com