

MicroLine Track Lighting

24V

MicroLine er et lite og dekorativt skinneresystem for utenpåliggende og innfelt montasje. Spottene kommer i ulike størrelser og med ulike funksjoner. Adapteret på spotten blir skjult i skinnen, noe som gir et delikat og minimalistisk design. Kommer i fargene sort og hvit.

Skinnene kommer i lengder på 1m og 2m og bygger kun 2,7cm / 2,8cm i høyden og 1,9cm / 2,8cm i dybden. Skinnene kan skjøtes sammen for å lage lengre strekk og vinkler.



Reddot vinner

Produktdesign

Red Dot Award (Red Dot Design Award) er en internasjonalt anerkjent utmerkelse for god design, som årlig utdeles av Design Zentrum Nordrhein Westfalen.

Red Dot Award er fra 1955 årlig utdelt for arbeid som har en utsøkt designkvalitet. Prisen deles ut av en sakkyndig jury.



Zoom funksjon

Innfelt



Utenpåliggende



MICROLINE - SPOTTER

MicroLine - GAMMA

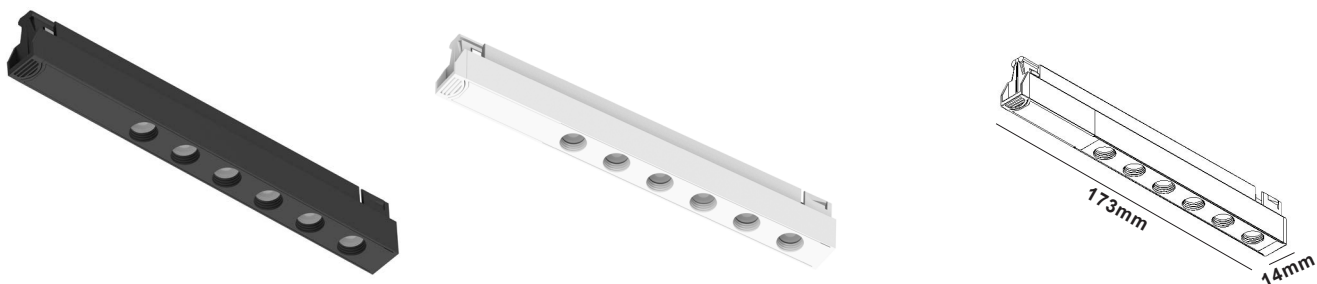

Art. nr.	Farge	Kelvin	CRI	Lumen	Watt	Spredning	Dimbar
382431005	■ Graphite Black	2700	>90	600	7,4	36°	Fase avsnitt
382431006	□ Pure White	2700	>90	600	7,4	36°	Fase avsnitt

MicroLine - BETA



Tiltbar: 90°
Roterbar: 355°

Art. nr.	Farge	Kelvin	CRI	Lumen	Watt	Spredning	Dimbar
382421005	■ Graphite Black	2700	>90	660	8	10-40°	Fase avsnitt
382421006	□ Pure White	2700	>90	660	8	10-40°	Fase avsnitt

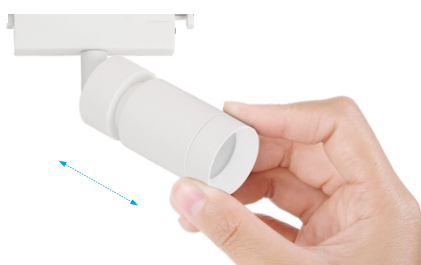

Justerbar spredning
Trekk ut for smalere spredning

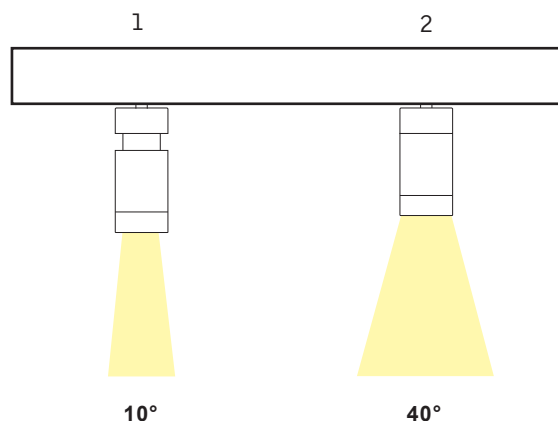

10-40° spredning
Juster mellom 10-40° spredning

Montering av spot



1
Monter spotten i i skinnen. Sørg for av låsen på siden er trykket ned / til siden før montering.

Merk: Spottene kan monteres hvor som helst på skinnen og begge veier.

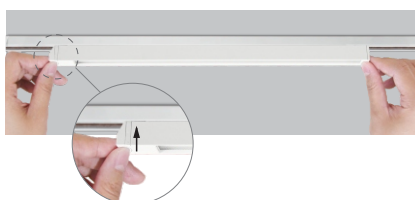

2
Når spotten er montert i skinnen, press så låsen ned / til motsatt side for å feste spotten til skinnen.

Løsne på låsen for å endre plassering av spotten.

MICROLINE - UTENPÅLIGGENDE SKINNE

Skinne for utenpåliggende montasje. Skinnene kommer i 1m og 2m lengder, men kan kappes i ønsket lengde. Velg mellom ulike skjøter for å tilpasse skinneresystemet etter eget ønske.

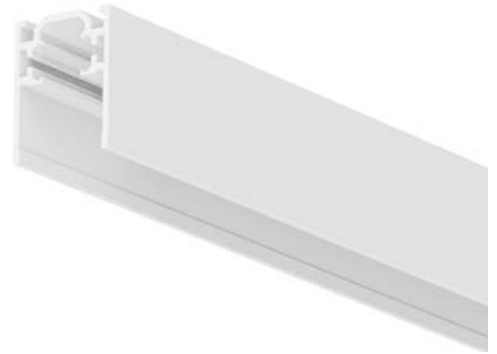
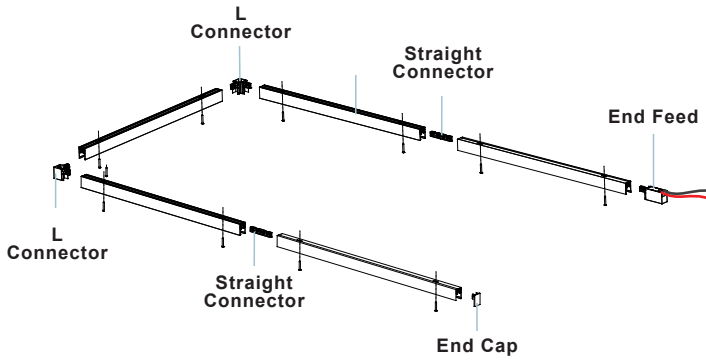
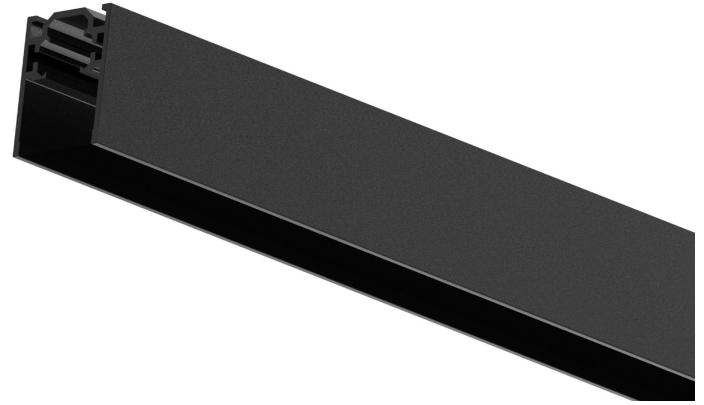

Bærevekt

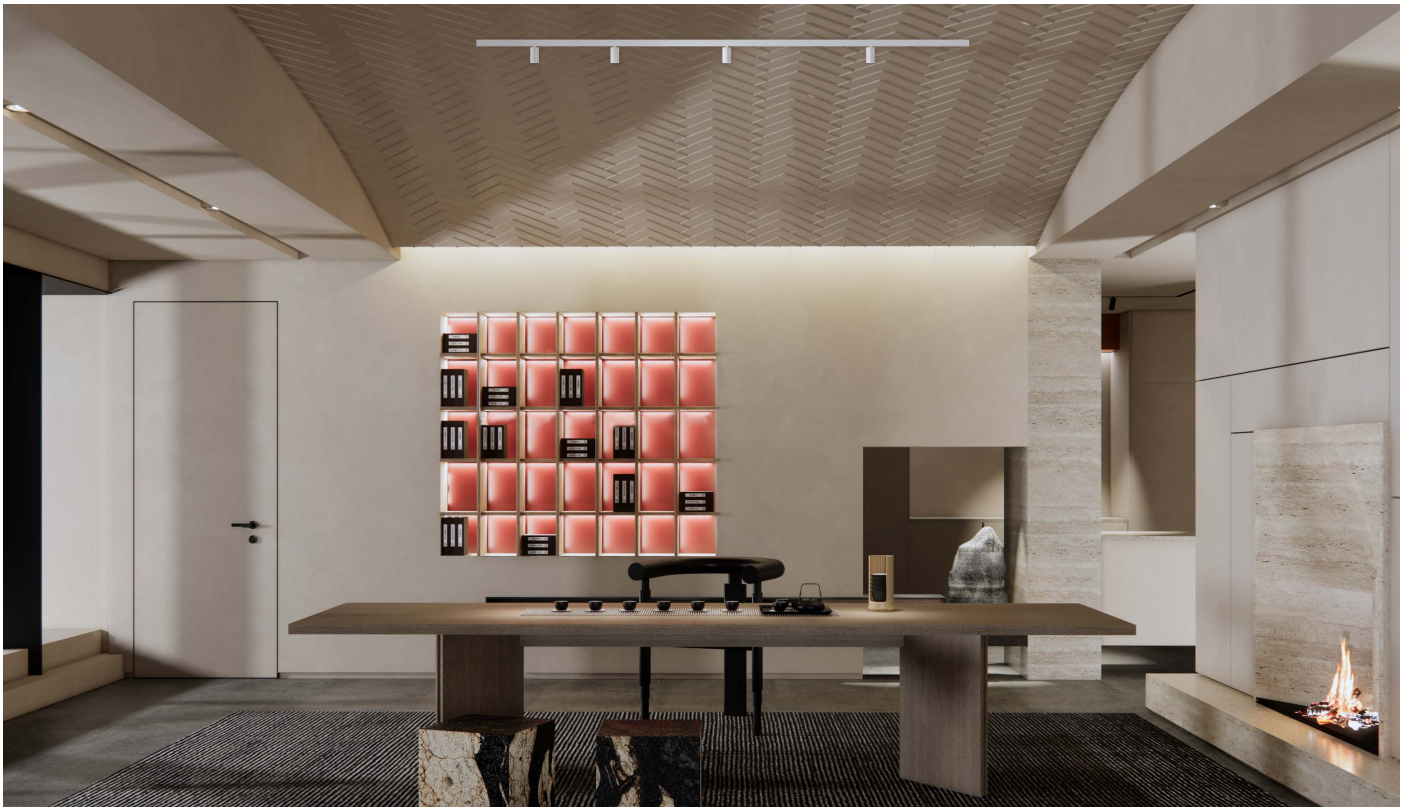
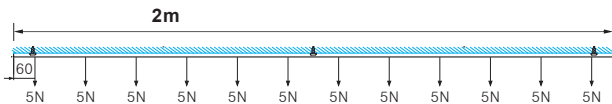
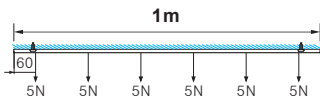

MICROLINE - UTENPÅLIGGENDE SKINNE

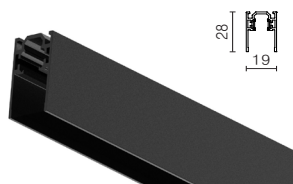

Microline Track - 1M

Art. nr.	Farge
382400106	<input type="checkbox"/> White
382400105	<input checked="" type="checkbox"/> Black

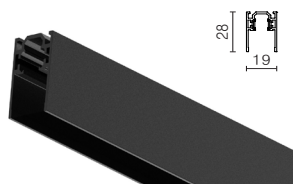

Microline Track - 2M

Art. nr.	Farge
382400206	<input type="checkbox"/> White
382400205	<input checked="" type="checkbox"/> Black

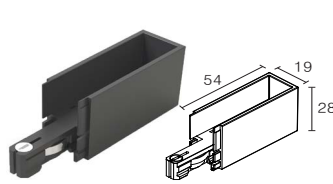

Microline End Feed

Art. nr.	Farge
382401006	<input type="checkbox"/> White
382401005	<input checked="" type="checkbox"/> Black

Endetilkobling. Kan benyttes i begge ender på skinnen.

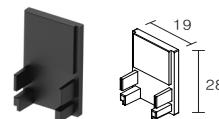

Microline End Cap

Art. nr.	Farge
382401306	<input type="checkbox"/> White
382401305	<input checked="" type="checkbox"/> Black

Endelukk. Kan benyttes i begge ender på skinnen.

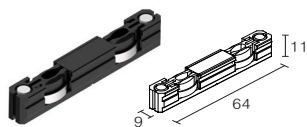

Microline Straight Connector

Art. nr.	Farge
382401106	<input type="checkbox"/> White
382401105	<input checked="" type="checkbox"/> Black

180° skjøt. Benyttes mellom to skinner.

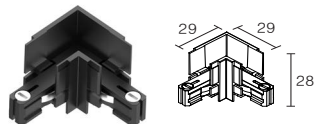

Microline L-Connector

Art. nr.	Farge
382401206	<input type="checkbox"/> White
382401205	<input checked="" type="checkbox"/> Black

180° skjøt. Benyttes mellom to skinner.

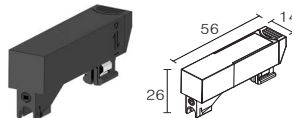

Microline Middle Feed

Art. nr.	Farge
382401406	<input type="checkbox"/> White
382401405	<input checked="" type="checkbox"/> Black

Sentertilkobling. Kan benyttes som alternativ strømtilkobling. Strømførende kabel termineres i komponenten, som kan plasseres hvor som helst på skinnen.



Microline Cover - 1m

Art. nr.	Farge
382401506	<input type="checkbox"/> White
382401505	<input checked="" type="checkbox"/> Black

Avdekning. Kan benyttes for å skjule innsiden av skinnen.

MICROLINE - INNFELT SKINNE

Skinne for innfelt montasje. Skinnene kommer i 1m og 2m lengder, men kan kappes i ønsket lengde. Velg mellom ulike skjøter for å tilpasse skinnesystemet etter eget ønske.

Leveres inkl. monteringsklips.

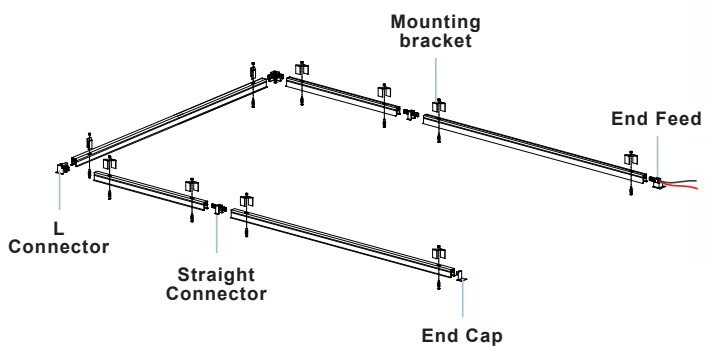

Bærevekt

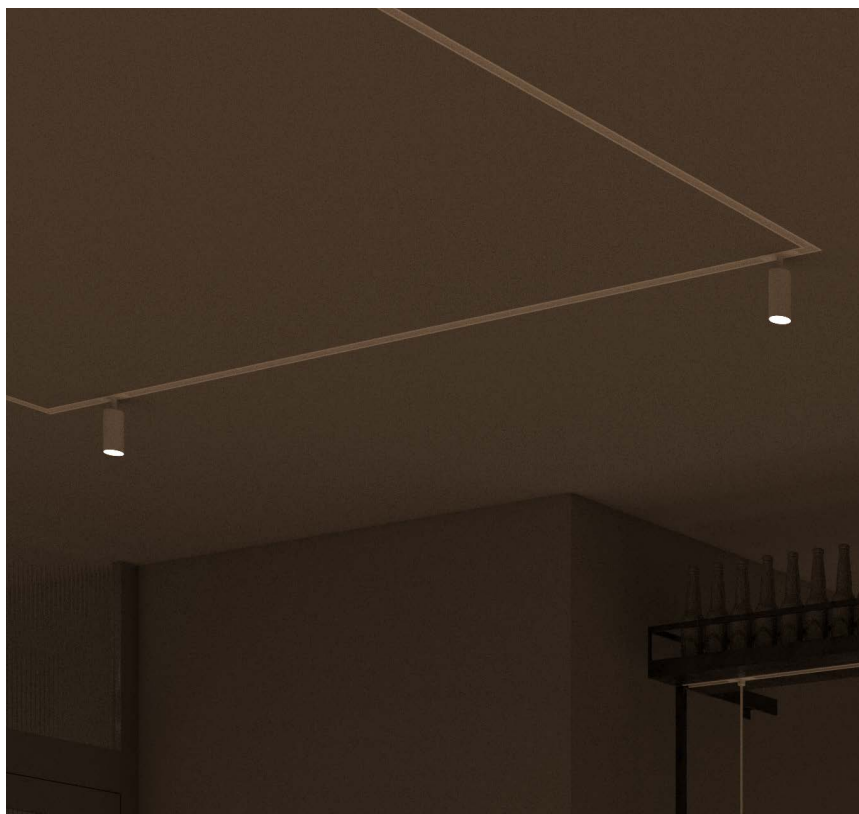
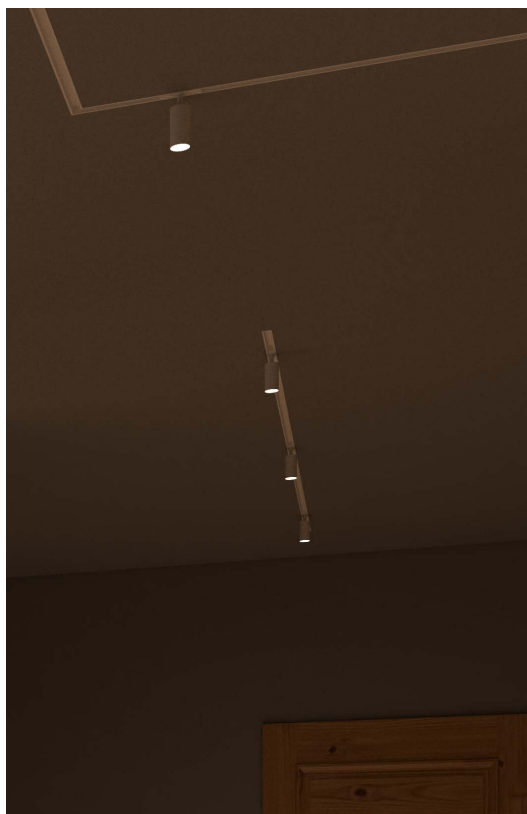
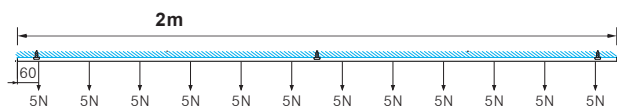
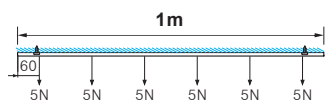

MICROLINE - INNFELT SKINNE

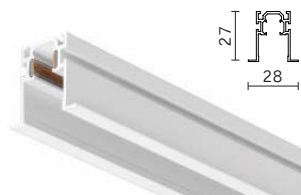

Microline Recessed Track - 1M

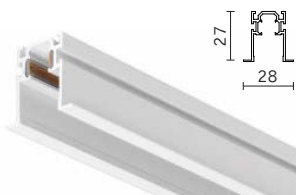

Microline Recessed Track - 2M

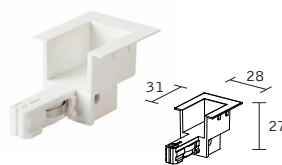

Microline Recessed End Feed

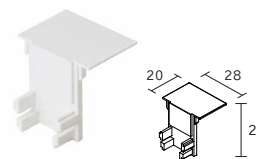

Microline Recessed End Cap

Art. nr.	Farge
382490106	☐ White
382490105	■ Black

Inkl. 2 stk. mounting clips

Art. nr.	Farge
382490206	☐ White
382490205	■ Black

Inkl. 3 stk. mounting clips

Art. nr.	Farge
382491006	☐ White
382491005	■ Black

Endetilkobling. Kan benyttes i begge ender på skinnen.

Art. nr.	Farge
382491306	☐ White
382491305	■ Black

Endelokk. Kan benyttes i begge ender på skinnen.

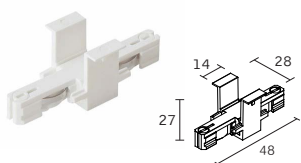

Microline Recessed Straight Connector

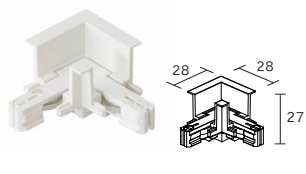

Microline Recessed L-Connector

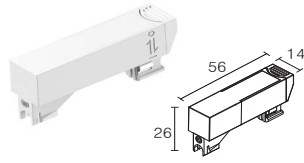

Microline Middle Feed



Microline Cover - 1m

Art. nr.	Farge
382491106	☐ White
382491105	■ Black

180° skjøt. Benyttes mellom to skinner.

Art. nr.	Farge
382491206	☐ White
382491205	■ Black

180° skjøt. Benyttes mellom to skinner.

Art. nr.	Farge
382401406	☐ White
382401405	■ Black

Sentertilkobling. Kan benyttes som alternativ strømtilkobling. Strømførende kabel termineres i komponenten, som kan plasseres hvor som helst på skinnen.

Art. nr.	Farge
382401506	☐ White
382401505	■ Black

Avdekning. Kan benyttes for å skjule innsiden av skinnen.

Hullmål på deler:

Track	L: 1000 / 2000 x B: 23mm	
End Feed	L: 24mm x B: 23mm	
Straight Connector	L: 14mm x B: 23mm	
L Connector	L: 25mm x B: 23mm	
End Cap	L: 2mm x B: 23mm	
Mounting Clip	B: 23mm	

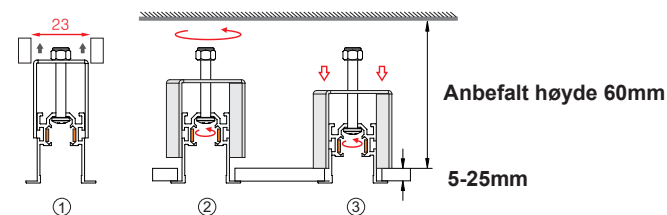
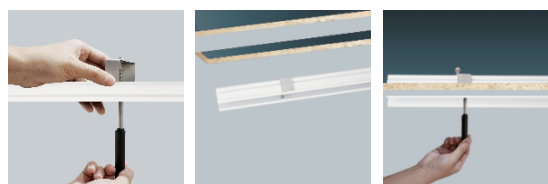

Monteringsklips:

Sørg for at "vingene" på monteringsklipsene er tett inntil skinnen når den føres på plass opp i det utskjærte sporet. Benytt et håndholdt skrujern og stram til skruen. Dette vil sørge for at "vingene" slår seg ut og trekker seg ned mot underlaget.

STRØMFORSYNING

- Constant Voltage
- Selv (Safety Extra Low Voltage)
- Driftstemperatur -20° ~ +45°

Dimbar fase avsnitt

- Se datablad for mer detaljert info

- Flicker Free
- Høy Power Factor PF>0,95
- Full dimming range: 0-100%
- 10% minimumsbelastning

SC Power LED Trafo 36W

Art. nr. 291036124

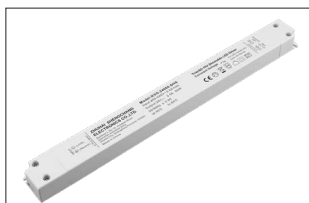

Input V: 220-240V
Output W: 36W
IP: 20

Beskyttelsesklasse: II
Tilkobling: Terminalkl.
Dimbar: Fase avsnitt

Høyde: 1,85cm
Bredde: 26,0cm
Dybde: 3,0cm

SC Power LED Trafo 60W

Art. nr. 291060124v2

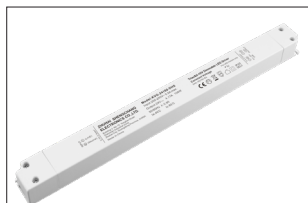

Input V: 220-240V
Output W: 60W
IP: 20

Beskyttelsesklasse: II
Tilkobling: Terminalkl.
Dimbar: Fase avsnitt

Høyde: 1,85cm
Bredde: 30,0cm
Dybde: 3,0cm

SC Power LED Trafo 100W

Art. nr. 291100124v2

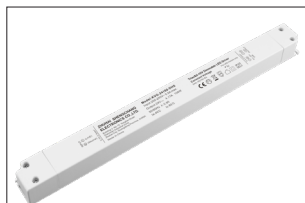

Input V: 220-240V
Output W: 100W
IP: 20

Beskyttelsesklasse: II
Tilkobling: Terminalkl.
Dimbar: Fase avsnitt

Høyde: 3,0cm
Bredde: 33,0cm
Dybde: 3,2cm

- Constant Voltage
- Selv (Safety Extra Low Voltage)
- Driftstemperatur -20° ~ +50°

Dimbar fase avsnitt

- Se datablad for mer detaljert info

AcTEC LED Trafo 25W 24V

Art. nr. 450250124



Input V: 220-240V
Output W: 25W
IP: 20

Beskyttelsesklasse: II
Tilkobling: Terminalkl.
Dimbar: Fase avsnitt

Høyde: 3,0cm
Bredde: 12,8cm
Dybde: 5,2cm

AcTEC LED Trafo 50W 24V

Art. nr. 450500124



Input V: 220-240V
Output W: 50W
IP: 20

Beskyttelsesklasse: II
Tilkobling: Terminalkl.
Dimbar: Fase avsnitt

Høyde: 3,2cm
Bredde: 18,4cm
Dybde: 6,1cm

TRAFOSKJULER

Trafoskjuler for SC Power LED Trafo

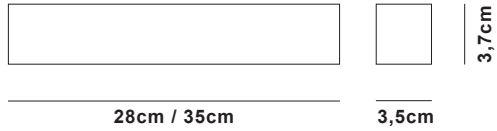

MicroLine Transformer Housing - 28cm

Art. nr. 333735286

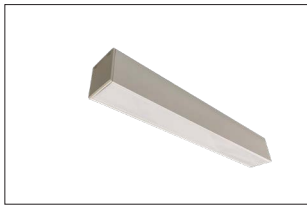

Farge: Hvit
Kompatibel med: 36W

MicroLine Transformer Housing - 28cm

Art. nr. 333735285

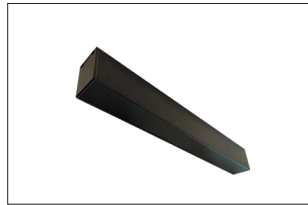

Farge: Sort
Kompatibel med: 36W

MicroLine Transformer Housing - 35cm

Art. nr. 333735356



Farge: Hvit
Kompatibel med: 36/60/100W

MicroLine Transformer Housing - 35cm

Art. nr. 333735355



Farge: Hvit
Kompatibel med: 36/60/100W

Tilkobling

End Feed

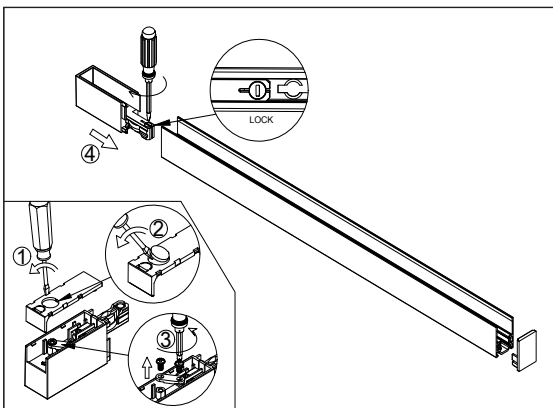

- 1: Løsne deksel på undersiden
- 2: Fjern plastlokk (uttappingshull) og tilkoble ledning
- 3: Løsne skruer på strekkavlaster og fest ledning
- 4: Monter endetilkoblingen i skinnen og lås av

Straight Connector

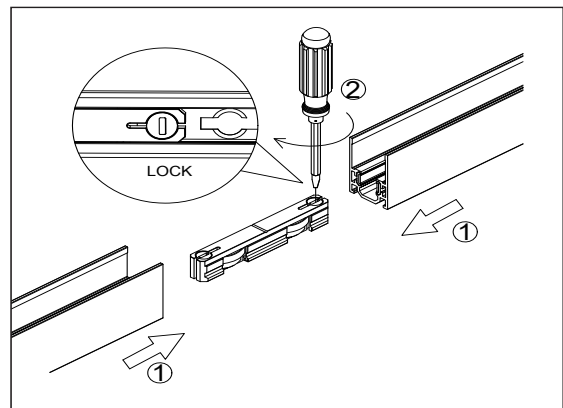

- 1: Monter skinnene på hver side
- 2: Lås av på hver side

L Connector

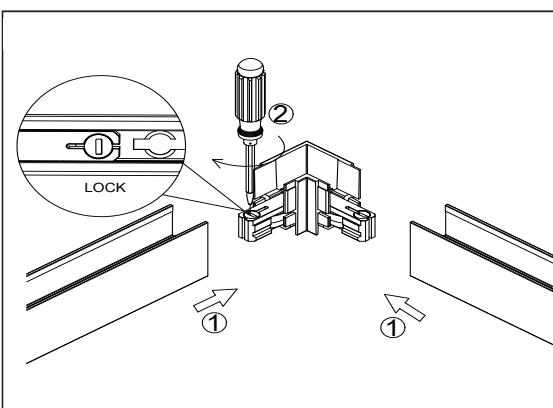

- 1: Monter skinnene på hver side
- 2: Lås av på hver side

Spot

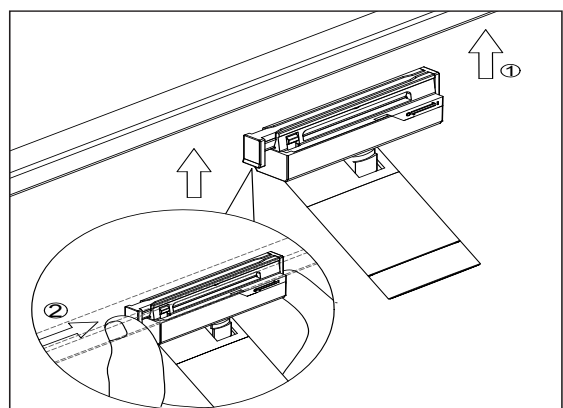

- 1: Plasser spotten i skinnen
- 2: Press låsepinnen over på motsatt side

Tilkobling

Middle Feed

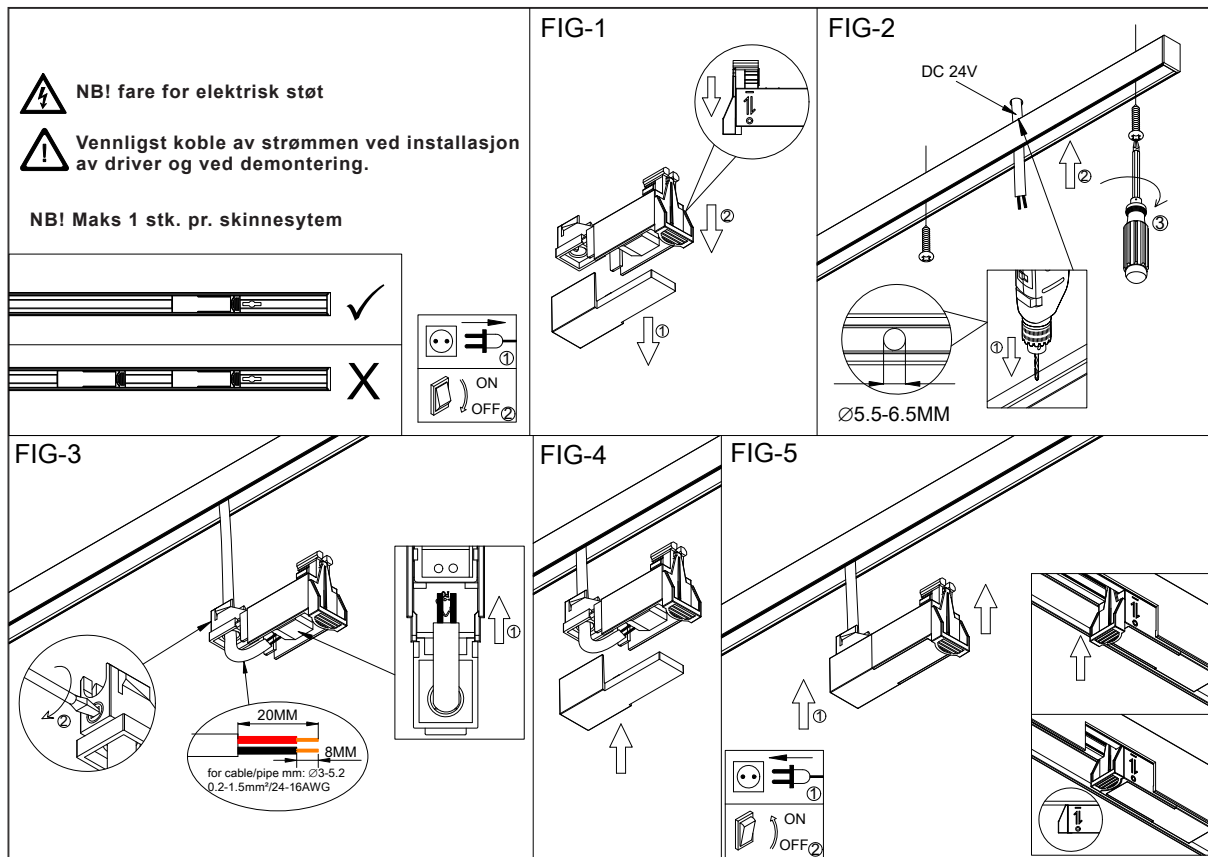







NORDESIGN

Hovedkontor, lager og showroom Trondheim
Brøsetekra 7, 7069 TRONDHEIM

Showroom Oslo
Drammensveien 130A4, 0277 OSLO

TLF: 73 84 95 50 / WWW.NORDESIGN.NO

