

# Advanced Mobile Power Systems

Unlimited 12V parallel battery bank  
Maximum series connection  
= 4 x 12 V = 48 V



Advanced Mobile Power Systems

READ ENTIRE MANUAL BEFORE USE

**LiFePO<sub>4</sub>**  
**100Ah / 120Ah**  
**12.8V (nominal).**  
**Lithium deep cycle battery.**  
**Automotive applications**



Smart battery  
includes internal BMS  
and safety shutdown

## Lithium batteries general overview

The advantages of lithium batteries are well known over conventional batteries. They are superior on every level - everyone wants them. However installing them on vehicles was not simple and required a lot of knowledge because they have a very specific envelope for their charging and discharging curves. Failure to operate within these parameters will reduce the performance ability and life of the battery. It may even destroy the battery and even cause a fire. This fear has led to many people backing off from the whole idea of lithium batteries.

For many years people have wanted a simple easy solution to installing lithium batteries in the automotive industry: Including commercial vehicles, campervans, caravans, military, police and ambulances. However, due to the specific incompatibility with charging voltages and currents on board the vehicles and the requirements of the battery, the two things simply could not safely be brought together without a very elaborate intermediary system linked into a BMS for the lithium battery. All this is not gone; today we have lithium batteries with built in BMS and automatic shutdown systems that take care of the extreme faults that may be presented to a lithium battery. With the simple addition of a Battery to Battery charger the correct voltage and current profile is provided to the battery from the vehicle's alternator with no integration fuss. This means, when your alternator voltage is low, the battery to battery charger increases the voltage and when your alternator's voltage is too high the battery to battery charger decreases it. Also, when you have too much current, the battery to battery charger reduces the current, thus, presenting the lithium battery with its ideal safe voltage and current requirements. This has never been so important than with the modern Euro 5/6 vehicle applications. The first, all in one - simple to install - package that removes all fears with this technology for application on vehicles.

## Key installation points and advantages - using 100Ah model as example.

**Performance:** Because a 100Ah lithium battery allows total access to the full 100Ah as opposed to a normal lead acid 100Ah battery which realistically only allows access to 50% - about 50 Ah. Therefore, you get the equivalent of 2 x 100Ah standard batteries to 1 lithium.

**Battery weight:** Battery size to battery size lithium is about 1/2 the weight of a conventional lead acid battery. However, because you get 2 x the power from the same battery, in fact, a lithium battery is about 1/4 the weight - power for power.

**Charge performance:** A lithium battery can charge much faster and fuller. I.e. when a normal lead acid battery is reaching its capacity the power intake tapers off very quickly. Not so much with lithium, it can sustain the charge curve for much longer. It also holds its output voltage longer ensuring maximum performance for the products attached to the battery.

**Life expectancy / economics:** A typical lithium battery will last between 10-20 times longer than a conventional battery making them very economical.

## The Safety, warranty and handling guidelines:

This battery has a 5 year guarantee as long as the following criteria are met.

Charging battery (on vehicle application)

- 1) Use a Sterling battery to battery charger to control the voltage and current for the battery charging
- 2) Maximum charge voltage 14.8V, nominal charge voltage 14.6V. Float voltage 13.8V
- 3) Maximum charge current, continuous charge current 0.5 C
- 4) Continuous discharge current 100A maximum discharge current 200A for 20 minutes. (120A and 300A for the 120Ah model).
- 5) Temperature operation, Charging 0-40 Deg C. Discharging -10 to 55 Deg C.

## Handling guidelines to prevent damage / fire / explosions

- 1) Fuse main output cable appropriately.
- 2) Do not reverse polarity the battery.

3) Use only lithium rated battery chargers.

4) Do not expose to large static electric fields or magnetic fields as this could damage the internal electronics.

5) Do not over heat or set fire to the battery as high risk of explosion.

6) Do not short circuit the battery.

7) Do not use the battery as a step.

8) Do not pierce the battery case or in any other way damage or destroy the integrity of the case.

9) In the event of any smell being detected from this battery, cease all operations involving charge and discharging and remove the battery immediately.

10) In the event of any leakage of any substances from the battery do not use gloves to handle the unit. If any of the substance get onto your skin or eyes flush with copious quantities of water and see a doctor immediately.

11) Long term storage it is advised to discharge the battery and re charge it every 3 months.

12) If battery is being wrapped then only use non-conductive paper.

13) After use, dispose of the battery in compliance with local country laws.

14) Do not crush the battery.

## Installation:

**This battery and charging system should be installed by a professional.**

**This product should be handled / treated like you would any other battery.**

Before installing ensure your charging profiles and discharging requirements fall within the specification of the battery. If your requirements exceed the rating of the battery, the battery will simply shut down for and stop operating for safety reasons.

If charging from a vehicle (especially a new Euro 6 ) you must use a Sterling Power Battery to Battery Charger to ensure correct charging voltages and current limits are adhered to.

How to choose your Battery to Battery Charger:

Check your total C rating for the battery. If the continuous C rating is 0.5 for a 100Ah battery then 50A is the maximum input current. The maximum Battery to Battery Charger you could use would be the BB1260 (BB1260 is 60A input and around 50A output, going into your lithium battery). If you have 2 batteries then the C rating remains the same but the total would be 100A charge. This is the maximum size product, however, you can use the small sizes. There are 20A or 30A models if you are not in a rush to charge. Ensure all cables are of the correct size (see chart over leaf) and the cables connected to the battery are all correctly fused both input and output wires (see fuse requirement over page).

Negative returns - most people put the negative to the chassis of the vehicle. We find that this is unreliable and not a great connection, we recommend you return the negative back to the negative of the starter battery using cable. You can also connect to the chassis if you wish but the main current would be going down the cable.

Ensure the battery is well secured and cannot move about when vehicle is in motion.

Position in a well protected, cool, dry environment .

Any worries / concerns installing this battery please contact AMPSystems.

## MATERIAL SAFETY DATA SHEET

For Rechargeable Li-Ion Battery 4S20P 12V100Ah of AMPSystems Ltd

### 1. CHEMICAL PRODUCT AND COMPANY IDENTIFICATION

#### PRODUCT IDENTIFICATION

Lithium Ion Battery  
4S20P 12V100Ah 1,280Wh/battery pack  
The UN classification number: Class 9  
UN Number: UN3480 lithium ion batteries  
AMPSystems Ltd, Droitwich, England WR90NX  
Tel 01905 771771 www.ampsystems.com

### 2. COMPOSITION INFORMATION

Common chemical name / General name	CAS number	Concentration range
Lithium Cobalt Oxides (active Material)	12190-79-3	30 ~ 50 %
Polyvinylidene Fluoride (binder)	24937-79-9	0.5 ~ 3 %
Graphite (conductive material)	1333-86-4	0.1 ~ 1 %
Graphite (active material)	7782-42-5	10 ~ 30 %
Organic Solvent (gel type electrolyte)	N/A	7 ~ 17 %

### 3. HAZARDS IDENTIFICATION Emergency Overview

The battery should not be opened or burned since the following ingredients contained within the product that could be harmful under some circumstance if exposed or misuse.  
PRIMARY ROUTES

Skin contact, Skin absorption, Eye contact, Inhalation, and Ingestion: NO

Skin contact No, Skin absorption No, Eye contact No, Inhalation No, Ingestion No

#### SIGNS AND SYMPTOMS OF EXPOSURE

Skin contact No effect under routine handling and use.

Skin absorption No effect under routine handling and use.

Eye contact No effect under routine handling and use.

Inhalation No effect under routine handling and use.

Ingestion No effect under routine handling and use.

Reported as Carcinogen Not applicable.

### 4. EMERGENCY AND FIRST AID MEASURES

INHALATION, EYE CONTACT, and SKIN CONTACT: Not a health hazard.

INGESTION: If swallowed, obtain medical attention immediately.

CAUTION: If exposure to internal materials within cell due to damaged outer casing, the following actions are recommended.

INHALATION: Leave area immediately and seek medical attention.

EYE CONTACT: Rinse eyes with water for 15 minutes and seek medical attention.

SKIN CONTACT: Wash area thoroughly with soap and water and seek medical attention.

INGESTION: Drink milk/water and induce vomiting; seek medical attention

### 5. FIRE FIGHTING MEASURES

Cell is not flammable but internal organic material will burn if the cell is incinerated. Combustion products include, but are not limited to hydrogen fluoride, carbon monoxide and carbon dioxide.  
EXTINGUISHING MEDIA

Use extinguishing media suitable for the materials that are burning.

#### SPECIAL FIRE FIGHTING INSTRUCTIONS

If possible, remove cell(s) from fire fighting area. If heated above 130°C, cell(s) may

Swell/explode/vent.

If package is damaged or heat, the package should be checked and repackaged well.

#### FIRE FIGHTING EQUIPMENT

Use NIOSH/MSHA approved full-face self-contained breathing apparatus (SCBA) with full protective gear.

### 6. ACCIDENTAL RELEASE MEASURES ON LAND

Place material into suitable containers and call local fire/police department.

IN WATER: If possible, remove from water and call local fire/police department

#### EXTINGUISHING MEDIA

Use extinguishing media suitable for the materials that are burning.

### 7. HANDLING AND STORAGE

Storage: Store in a cool, well-ventilated area. Do not expose to high temperature (60C+). Since short circuit can cause burn hazard or safety vent to open - do not store with metal jewellery, metal covered tables, or metal belt.

Handling: Do not disassemble, crush or solder. Do not short + and - terminals with a metal. Do not open the battery. Charging: Charge within the limits Charge with specified charger designed for this battery.

Discharging: Discharge within the limits.

Disposal: Dispose in accordance with applicable federal, State and local regulations.

Warning: Fire/Explosion and Severe Burn Hazard. Do not Crush, Disassemble, Heat Above 100C, or Incinerate.

### 8. EXPOSURE CONTROLS/PERSONAL PROTECTION

#### ENGINEERING CONTROLS

Keep away from heat and open flame. Store in a cool dry place

#### PERSONAL PROTECTION

Respirator: Not required during normal operations. SCBA required in the event of a fire.

Eye/face protection: Not required beyond safety practices of employer.

Gloves: Not required for handling of cells.

Foot protection: Steel toed shoes recommended for large container handling.

### 9. PHYSICAL AND CHEMICAL PROPERTIES

State	Solid
Odour	N/A
pH	N/A
Vapour density	N/A
Boiling point	N/A
Solubility in water	Insoluble
Specific gravity	N/A
Density	N/A

### 10. STABILITY AND REACTIVITY

REACTIVITY: None during normal operating or handling conditions.

INCOMPATIBILITIES: None (during normal operation). Avoid exposure to heat, open flame, and corrosives.

HAZARDOUS DECOMPOSITION PRODUCTS: None (during normal operating conditions). If cells are opened, hydrogen fluoride and carbon monoxide may be released.

CONDITIONS TO AVOID: Avoid exposure to heat and open flame. Do not puncture, crush or incinerate.

### 11. TOXICOLOGICAL INFORMATION

This product does not elicit toxicological properties during routine handling/use.

Sensitization / No. Acute toxicity / No. Teratogenicity / No. Reproductive toxicity / No.

This product does not contain any kinds of the following substances and halogen-type, flame retardants including Chlorine and Bromide type harmful flame retardants which are listed in appendix of TCO documents and relevant international ECO requirements.

Polybromated Biphenyls (PBB)  
Polybromated Biphenyl Ethers (PBBE)  
Polybromated Biphenyl Oxides (PBBO)  
Polybromated Diphenylethers (PBDE)  
Polychlorinated Biphenyl (PCB)  
Polychlorinated Diphenylethers (PCDE)  
Tetrabromophenol A (TBBPA)

Asbestos, Antimonytrioxide, Dioxine /

None of the following substances will be exposed, leaked, or emitted during transportation, storage or any operation and any temperature condition:

Chlorinated Fluorohydrocarbon (FCKW), Acrylonitrile, Styrol, Phenol, Benzol, Mercury of greater than 0.0001 wt% for alkaline battery, Mercury of greater than 0.0005 wt% for other battery, Polymer content of greater than 0.5g/cell, 1.5g/battery, Cadmium, lead, and other harmful heavy metal

This product does not contain mercury, cadmium and Polymer-metal.

Mercury content N/A. Polymer-metal N/A. Cadmium content N/A.

### CAUTION

If the cells are opened through misuse or damage, discard immediately. Internal components of cell are irritants and sensitizers.

### 12. ECOLOGICAL INFORMATION

Some materials within the cell are bio-accumulative. Under normal conditions, these materials are contained and pose no risk to persons or the surrounding environment.

### 13. DISPOSAL CONSIDERATIONS

CALIFORNIA REGULATED DEBRIS RCRA Waste Code: Non-regulated

Dispose of according to all federal, state, and local regulations.

### 14. TRANSPORT INFORMATION

UN Number: UN 3840

Proper Shipping Name: LITHIUM ION BATTERIES

Hazard class: 9

Packing group: II

In the case of transportation, avoid exposure to high temperature and prevent the formation of any condensation. Take in a cargo of them without falling, dropping and breakage. Prevent collapse of cargo piles and wet by rain. The container must be handled carefully. Do not give shocks that result in a mark of hitting on a pack. Please refer to Section 7-HANDLING AND STORAGE also.

### 15. REGULATORY INFORMATION

With regard to sea transport, the following regulations are cited and considered:

I) The International Maritime Dangerous Goods (IMDG) Code (2014 Edition) with SP188)

II) The US Hazardous Materials Regulation (HMR) pursuant to a final rule issued by RSPA (Part 49 CFR Sections 100-185),

III) The Office of Hazardous Materials Safety within the US Department of Transportation's (DOT) Research and Special Programs Administration (RSPA), and  
VI) The UN Recommendations on the Transport of Dangerous Goods Model Regulations and the Manual of Tests and Criteria (UN38.3)

Our products are properly classified, described, packaged, marked, and labelled, and are in proper condition for transportation according to all the applicable international and national governmental regulations, not limited to the above mentioned. We further certify that the enclosed products have been tested and fulfilled the requirements and conditions in accordance with UN Recommendations (T1:T8) on the Transport of Dangerous Goods Model Regulations.

Manual of Test and Criteria (38.3 Polymer Lithium ion battery)

Test Item Test Results Remark

T1 Altitude Simulation Pass

T2 Thermal Test Pass

T3 Vibration Pass

T4 Shock Pass

T5 External Short Circuit Pass

T6 Impact Pass

T7 Overcharge Pass For Pack Only

T8 Forced Discharge Pass For Cell Only

### 16. OTHER INFORMATION

This Sheet is provided as technical information only. The information and recommendations set forth are made in good faith and believed to be accurate as of the date of preparation. AMPSystems Ltd makes no warranty, expressed or implied, with respect to this information and disclaims all liabilities from reliance on it except normal transport according to the correct transport conditions.

### Warranty:

**5 year warranty from date of purchase of the original battery. Based on correct installation and maintaining the charge profile and discharge limits as per specification. This does not include mishandling or damage to the battery due to misuse.**



# Battery to Battery Chargers 12V | 24V | 36V | 48V

## Non Waterproof (Drip Proof IP21) 15A-70A Input Models

(larger units overleaf)

**Euro 6+ friendly**

Sterling's range of Battery to Battery Chargers (B2Bs) has grown significantly over the past few years. Offering a product range in this market unsurpassed by anyone in both power and flexibility. This is in an effort to supplement the ever growing demand from the commercial vehicle, recreational vehicle and marine industries. The B2Bs have become extremely popular as they fast charge batteries as you cruise along without the need for complex wiring, touching your alternator, voiding the alternator's warranty and tampering with the electronic control units (ECUs). You can provide the onboard batteries with a fast 4 stage charging profile with a very simple and speedy installation. All of the benefits of advanced charging without any of the drawbacks. Simply connect the B2B between the battery being charged and the battery you wish to charge.

Read about regenerative braking and the test that Sterling did. **Page 15.**



### 3 activation modes:

**1) Automatic** - Default, operates on input voltage (13.3V / 26.6V on) and complements regenerative braking with low voltage timer. No ignition feed required.

**2) Ignition feed with timer.** As above, however, requires a live ignition feed to operate. Input voltage figures and timings, as above.

**3) Ignition feed without timer.** As above, however, the timer does not kick in, so it can potentially stay on indefinitely provided input voltage stays above a certain low threshold.

**The default mode, which is Automatic Regenerative Braking Friendly, does not require an ignition feed to operate.** It works on input voltage and timing algorithms (These values can be customised on the unit). This is ideal for most setups as ignition feeds are getting increasingly hard to find on modern vehicles, this new unit is therefore simple to install.

**Very simple to install.** No Electronic Control Unit (ECU) issues. No complex wiring. No Warranty issues. Fully prepared for smart alternators (**Regenerative braking**). 95% off installations are simply out of the box with no setup.

**4 stage battery charging.** The B2B charges batteries between 5-20 times faster than a stand alone alternator.

**OEM lock:** the unit can be locked by the installer to prevent tampering and misuse of the product by the operators. By locking the BB, you secure all previous settings in place and prevent subsequent tampering.

**9 preset battery chemistry options** including AGM, LiFePO4, Gel, flooded and sealed lead acid.

**Customizable profile** - choose your own charging profile on the front panel.

**B2B turns on at 13.6V and turns off at 13.3V (x2 for 24V).** Thus, does not drain input battery. **Regenerative braking mode shall allow the input voltage to drop to 12.2V (x2 for 24V).**

**Boost / Reduce Charging.** The B2Bs ensure batteries get the correct charging profile irrespective of high or low input voltages.

**Night time setting** allows the unit to run at 1/2 power so the fan noise is kept down.

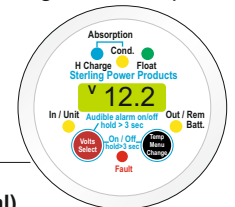

### Remote Control (Optional)

Displays: Voltage / Warnings / Temperatures. Can be used as an independent voltmeter measuring input battery voltage and output battery voltage.

Can remotely modify the Batt. the Batt. Charger:

- Force the unit to float
- Force the unit to 1/2 current limit
- Force the unit to standby
- Force the unit off
- Force the unit to Night Mode
- Reset both Remote and Charger

E marked. Suitable for OEM fitting.



© Trademark of Mercedes Benz



© Trademark of Vauxhall / Opel



© Trademark of Volkswagen



© Trademark of Ford

Output charging at **12V, 24V, 36V and 48V.** Input voltages at **12V and 24V. Up to 800W rating.** Much larger model up to 3000W coming soon.

**No risk off starter battery discharge. Current is NOT taken from the input battery** and given to the output battery except during the low voltage timer for regenerative braking mode. This time frame can be increased in length or brought down to 0 seconds.

### Safety features:

- 100% fire proof plastic box
- no screws to corrode
- thermal power reduction
- multi stage fan cooling

**Dynamic thermal charging,** the charging voltage fluctuates based on the temperature of the sensor (included ->).

1 x temperature sensor (TSAY) included in all units except the BB1215 where it can be purchased as an optional extra.

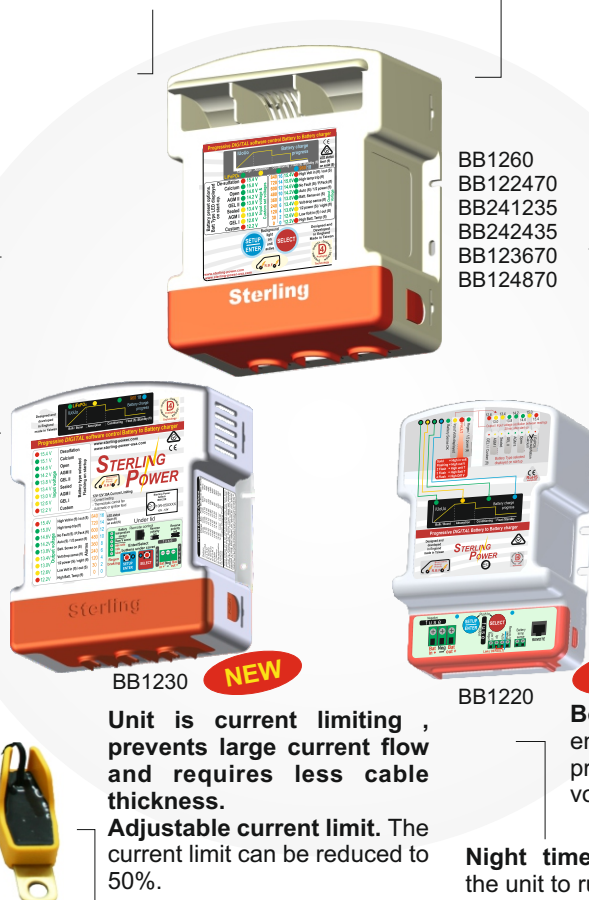

BB1260  
BB122470  
BB241235  
BB242435  
BB123670  
BB124870

BB1230

**NEW**

**Unit is current limiting, prevents large current flow and requires less cable thickness.**

**Adjustable current limit.** The current limit can be reduced to 50%.

BB1220

**NEW**

**Boost / Reduce Charging.** The B2Bs ensure batteries get the correct charging profile irrespective of high or low input voltages.

DC V (in)	DC V (out)	Current (A)	Weight (Kg)	L x W x D mm	Code
12V	12V	20A input	0.9	160 x 96 x 55	BB1220
12V	12V	30A input	1.2	190 x 160 x 50	BB1230
12V	12V	60A input	1.4	190 x 160 x 70	BB1260
12V	24V	70A input	1.4	190 x 160 x 70	BB122470
12V	36V	70A input	1.4	190 x 160 x 70	BB123670
12V	48V	70A input	1.4	190 x 160 x 70	BB124870
24V	24V	35A input	1.4	190 x 160 x 70	BB242435
24V	12V	35A input	1.4	190 x 160 x 70	BB241235

Remote w/ 10m cable

BBURC

German, French, Spanish main label overlay sticker



All cables connected to any battery must be correctly installed. They must be fused as close to the battery source as possible. Each fuse should be correctly rated for the individual applications and should be about 30% higher current than the maximum expected current. For example, assuming a 12-12V 60A battery to battery charger on a 100Ah lithium battery supplying a typical camper van with a 60A output demand:

- A) Battery to battery charger input - 80A fuse.
  - B) Battery to battery charger output - 80A fuse.
  - C) Auxiliary system - **150A fuse for 100 amp and 150 for 120A.**
- An extrapolation of this, is depicted below.

# Fuses and cables

**Warning:**  
Lithium batteries have very specific overload limits which should not be exceeded. Battery will shut down in event of overload.

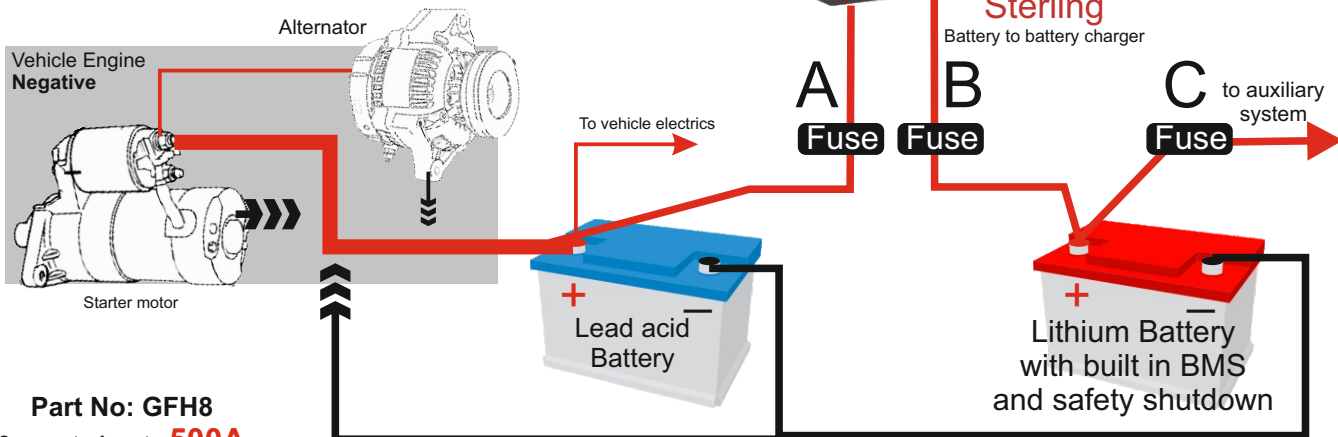

**Part No: GFH8**  
8 mm stud up to **500A**  
single ANL fuse holder

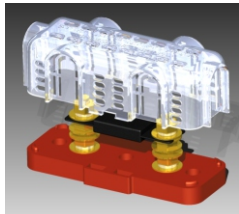

size 145L 55W 53H mm

1 FUSE GANL PER PACK



**Part No: GANL /?AMPS**

Mica window

80A 250A 100A 300A  
150A 350A 200A 400A  
500A

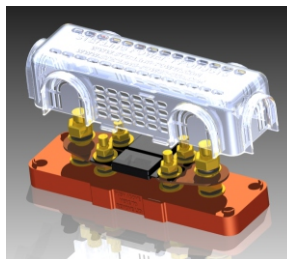

**Part Nos: GFH12**  
12 mm stud up to **1000A**  
twin ANL fuse holder

size 200L 66W 69H mm

Safety regulations demands any cable directly connected to a battery source must be fused

**Required Current based at approx 60 deg C 12V** Warning: this is total cable length not distance to product remember to add the pos and neg cable length as total

**This chart for general reference only, cables sizes vary with ambient temperatures and other aspects**  
**Use only multi strand cable not solid core cable.**

Voltage drop specification	Higher voltage drop Lights, pumps Non Critical equipment	Low voltage drop inverters chargers Critical equipment	Cable length meters																			
			5A	10A	15A	20A	25A	30A	40A	50A	60A	70A	80A	90A	100A	120A	150A	200A	300A	400A		
0-6	0-2																					
6-9	2-3																					
9-15	3- 4.5																					
15- 19	4.5- 6																					
19-24	6-7.5																					
24-30	7.5-9																					
30-40	9-12																					
40-51	12-15																					
51-61	15-18																					
	18-21																					
	21-24																					
	24-27																					
	27-30																					
	30-33																					
	33-37																					
	37-40																					

AWG American Wire Gauge	Copper diameter mm	Copper Cross sectional mm sq	AWG American Wire Gauge	Copper diameter mm	Copper Cross sectional mm sq	AWG American Wire Gauge	Copper diameter mm	Copper Cross sectional mm sq
16	1.29	1.5	8	3.26	10.0	1	7.35	50.00
14	1.63	2.5	6	4.11	16.0	0	8.25	60.00
12	2.05	4.0	4	5.19	25.0	00	9.27	70.00
10	2.59	6.0	2	6.54	35.0	000	10.40	95.00
						0000	11.68	120.00

For unknown cable simply measure **copper conduit** diameter and equate to the above chart. do not measure the cable insulation diameter. The mm sq figure is rounded up for Euro cables.



Please note the below information is for **AMPSystems** batteries only with integrated **internal BMS and shutdown**.

Do not use the below ideas with normal lithium cells with no BMS and auto shutdown.

To avoid clutter, no fuses are shown on these quick reference diagrams.

See previous page to see where fuses should be used.

## Standard engine / alternator charge system

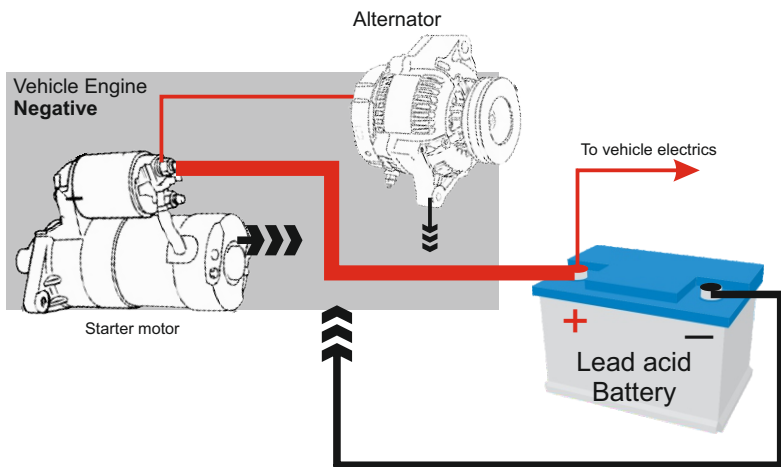

Conventional boat or car engine setup. The alternator output connects to the starter battery, usually at the starter's motor terminal (for convenience only). Some alternator's cables go direct to the starter battery.

## How to and not to add an auxiliary lithium battery bank

### How NOT to install a lithium battery

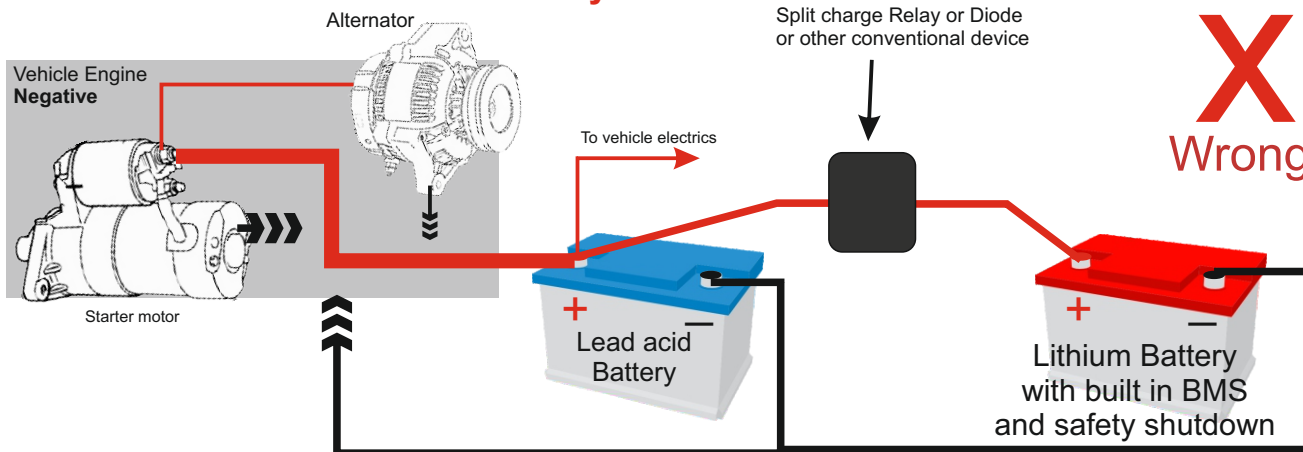

Because conventional splitting systems simply connect the starter battery with the lithium battery they do not offer the lithium battery the charge voltage and current protection it requires for a safe operational life. They do not deal with the following problems: 1) Low voltage: a relay cannot increase the voltage when it is too low to charge the lithium battery. 2) High voltage, the relay cannot reduce the high dangerous voltage to a safe acceptable voltage. 3) Float voltage - when the lithium battery is full the relay cannot reduce the charge voltage to a safe float voltage. 4) Current limit: the relay cannot restrict the alternator current to ensure the battery only charges at acceptable current levels. The end result is the incorrect and very dangerous operation of the battery.

### Correct way to install a lithium battery

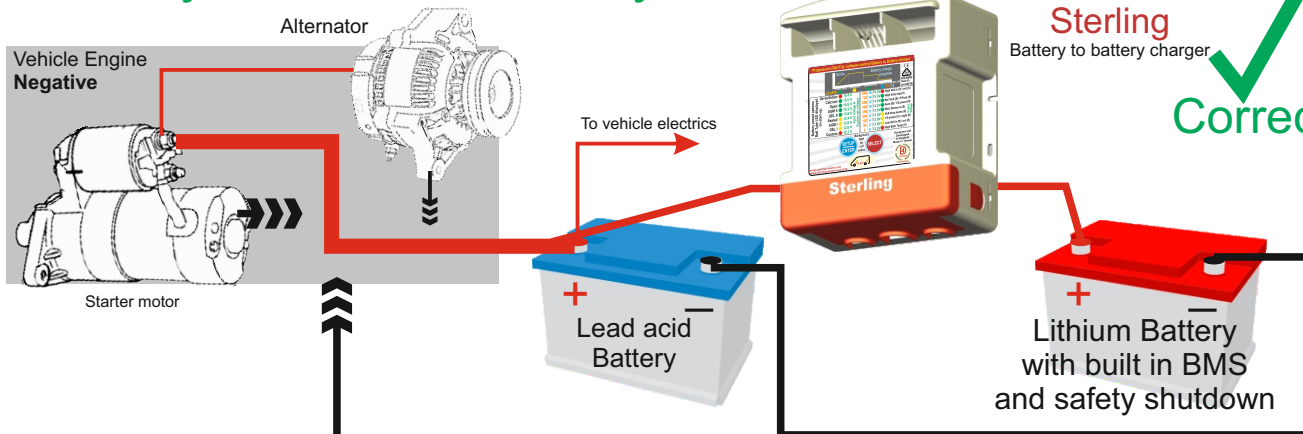

You must fit a Battery to Battery charger because it will offer the lithium the correct charge voltage and current for safe and reliable operation. It will fix the following problems: 1) Low voltage: when the voltage is low the battery to battery charger will boost the voltage up to the correct safe voltage required by the lithium battery. 2) High input voltage, with high input voltage the battery to battery charger will reduce the input voltage to the correct voltage for the lithium battery. 3) Float voltage, when the lithium battery is full the battery to battery charger will reduce the input voltage to a lower safe float voltage for the lithium battery, thus, preventing over charging. 4) Current limit: The battery to battery charger is current limiting and, even if your alternator is 200A, if you have a 50A battery to battery charger only 50A will be allowed into your battery and so over charging is avoided and the life and safety of the battery is preserved.

## Correct way to install larger battery banks / parallel operation a lithium battery. Add as many batteries as you wish

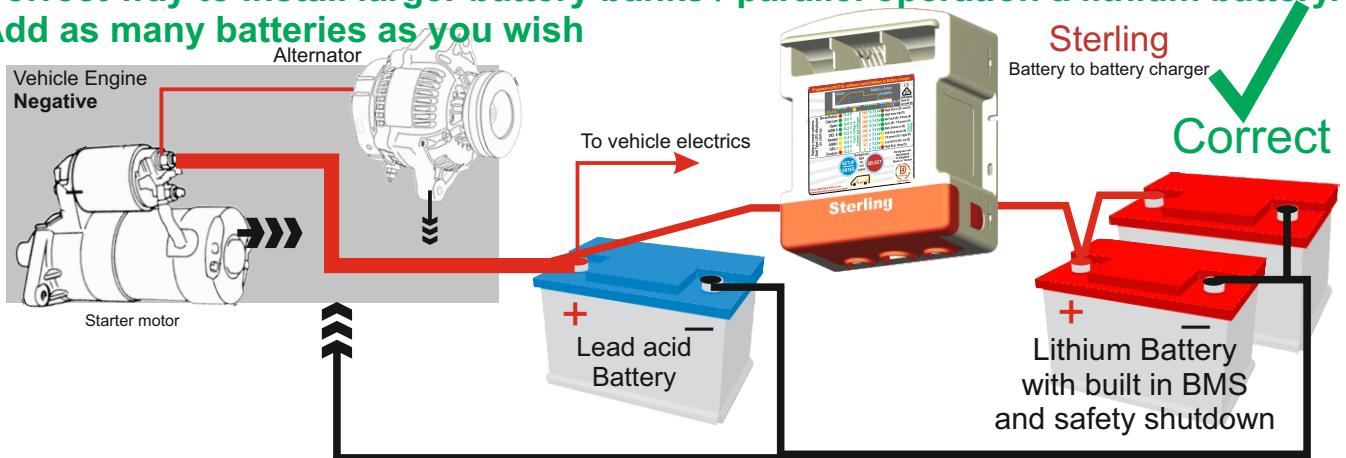

You may wish to increase the auxiliary battery bank size, this offers 3 advantages: 1) Increase in battery storage power giving longer time between charging. 2) Faster charge times, a larger battery to battery charger and so charge the batteries at 2 times the rate. 3) Direct power transmission, why plug into campsite shore power or purchase a dangerous petrol generator when you have a 1500-3000W generator under the bonnet of your vehicle. All you need to do is to access that power; a larger battery to battery charger allows you to transmit more power from your alternator not only to the auxiliary battery but also any ancillary power devices such as a larger inverter can benefit from more direct power from the alternator to the device.

For example, you have a 2000W inverter and you have a 1500W power requirement (hair dryer, kettle, microwave, angle grinder/welder, etc.) this represents about a 150A draw from the battery. A 100Ah battery would run this device for about 3/4 hr (45 mins). If you do not want to drain so much from your battery and you switched on the engine while operating this equipment if you have a 100Ah battery and a 30A battery to battery charger then about 25A would come direct from the alternator and 125A from the battery. The end result would be a flat battery within 48 mins. Let us assume you fitted the maximum size battery to battery charger you could on the 100Ah battery (the 60A Batt. to Batt.) this would put about 50A into your battery. With your 150A load, 100A would come from battery and 50A from the alternator and so your run time is now 60 minutes. Now, if you were to fit 2 x 100Ah battery then you could fit up to 120A battery to battery charger, this gives 100A direct power from the alternator and 50A from the batteries giving 4 hours of continual non-stop use of the equipment.

## Correct way to install larger battery banks / parallel operation of the Battery to Battery chargers

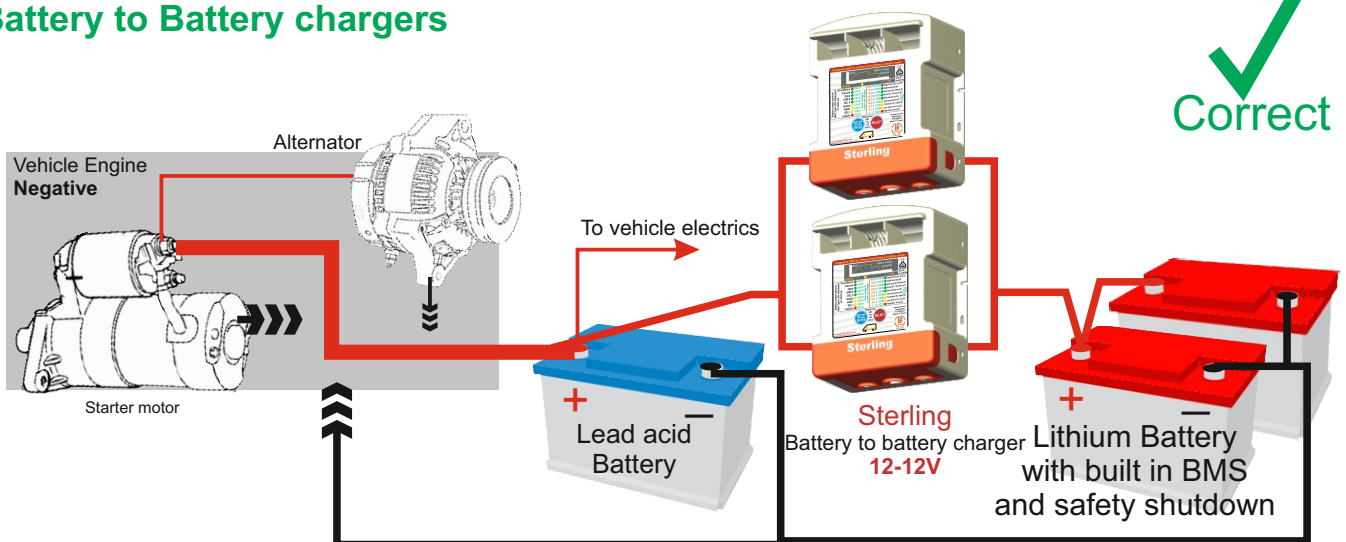

You may already have a single battery to battery system and wish to add another battery to battery charger to reduce your charge time or allow more through power. Rather than purchasing a larger battery to battery charger it is may be more economical to simply supplement the one you already have. The battery to battery chargers are digitally controlled so they do not worry if there are more of them in parallel. The only important thing to bear in mind is that the total output combined current of the battery to battery charger does not exceed the C rating of the lithium battery bank. If you have a 100Ah lithium battery bank, rated at a continuous charge C of 0.5 (which is 50A) then the total of the battery to battery charger's outputs cannot exceed 50A. This can be increased by adding an extra 100Ah lithium battery in parallel to make 200Ah. In this case the 0.5 C is now 100Ah and so 2 x 60A battery to battery chargers can be safely used. Remember, a 60A battery to battery charger is the input power, the output is more like 50A).

## Correct way to install larger direct alternator power transfer to end product without increasing battery banks size using a 'Lithium through power enhancer'

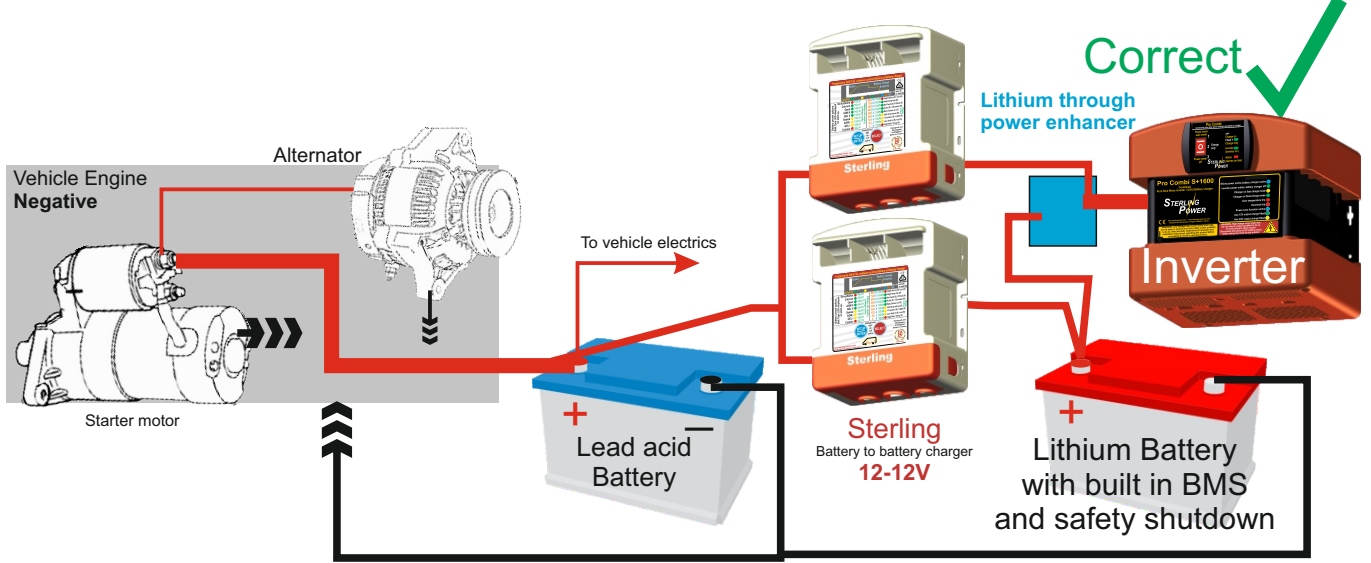

You may already have a single battery to battery system and wish to add another battery to battery charger to increase the through power to feed a larger inverter directly, from the engine's alternator when the engine is running. You may not have enough room to increase the battery bank size and you may also wish to reduce the cost of the installation. You cannot exceed the C rating of the charger for the battery, you can simply use the Sterling Power device (Lithium Through Power Enhancer) that allows you to add an extra battery to battery charger to utilise more power direct from the vehicle's alternator. You can run other equipment with the vehicle's engine running without damaging the lithium battery. If you had a work van with a kettle or you had a small camper van and wanted to run a hair dryer or coffee machine but wanted to reduce the battery contribution into the inverter and utilise more power from the alternator directly. Then you could simply add extra battery to battery chargers to use the surplus power from the alternator and reduce the demand from the battery system, thus allowing longer use for the high power drain. The only limitation to this system is the power rating from the vehicle alternator.

## Correct way to install varger voltage battery banks / series operation 12V in 24V out

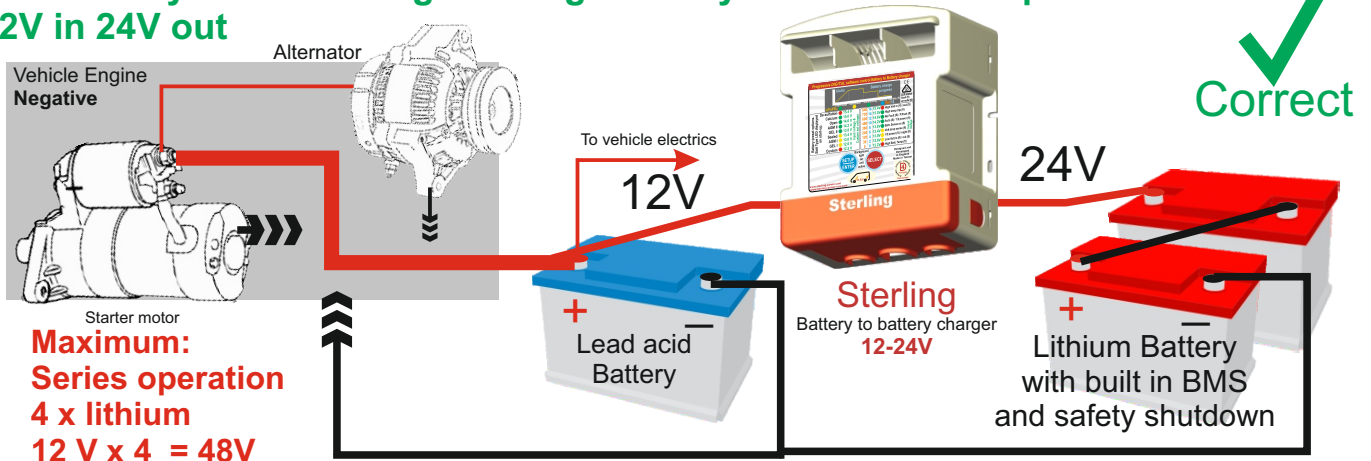

**Maximum:  
Series operation  
4 x lithium  
12 V x 4 = 48V**

You may have a 12V-24V requirement, a 12V-36V or 12V-48V. All options are available with the correct battery to battery charger. The maximum is 48V. No more than 4 batteries in series are allowed.



## Correct way to install multiple battery banks. 12V and 24V bank

Correct

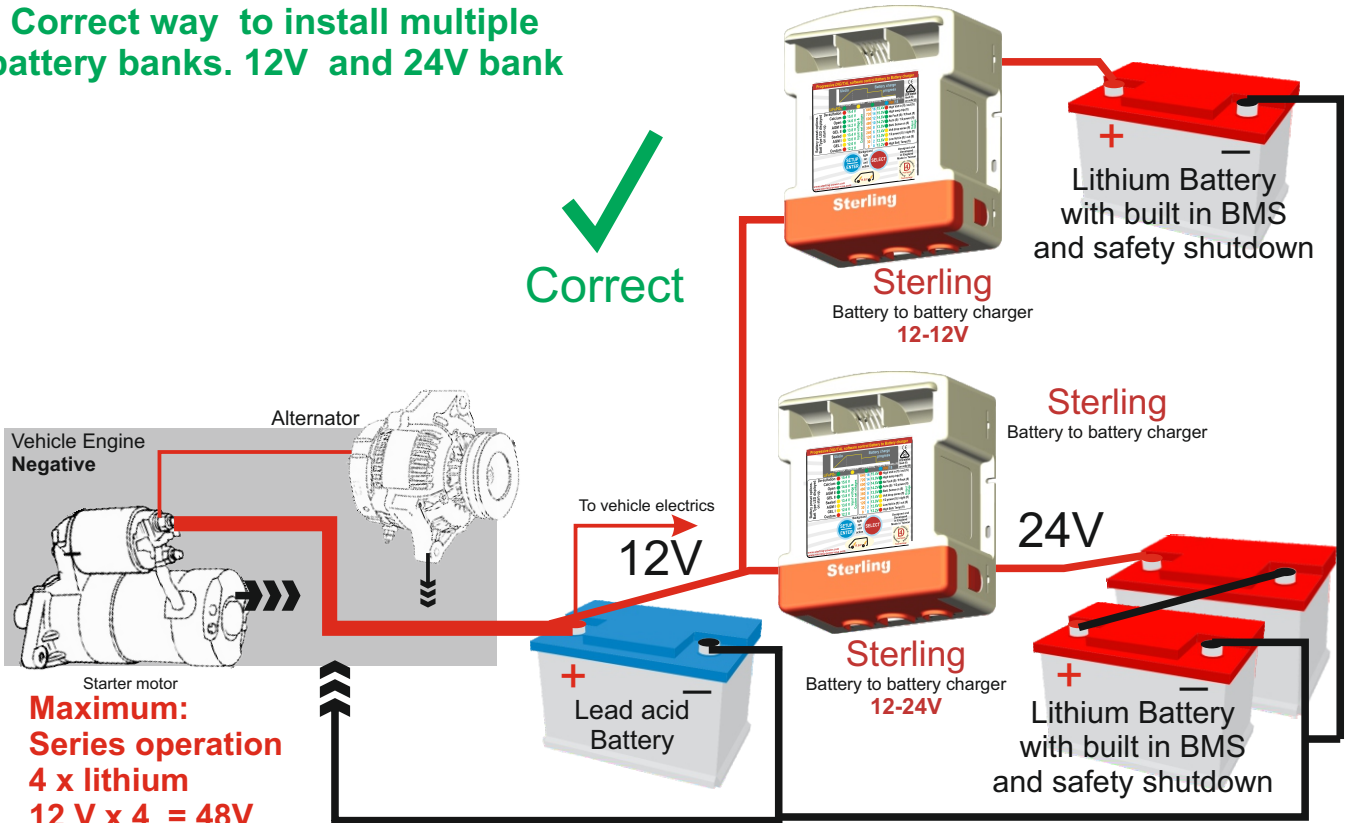

You may require more than one battery bank and also mixed voltage battery banks. Simply connect as many variants of the battery to battery charger as you wish. Ensure the correct voltage in and out. Make sure the total current capacity does not exceed the input alternator's capability as after the current is exceeded there is no more surplus power to operate the products effectively. There is no technical problem exceeding the ability only the fact that the maths will be affected accordingly.

12V-24V, 12V-36V or 12V-48V. All options are available with the correct battery to battery charger the maximum is 48V.

## Extra alternator install

Wrong

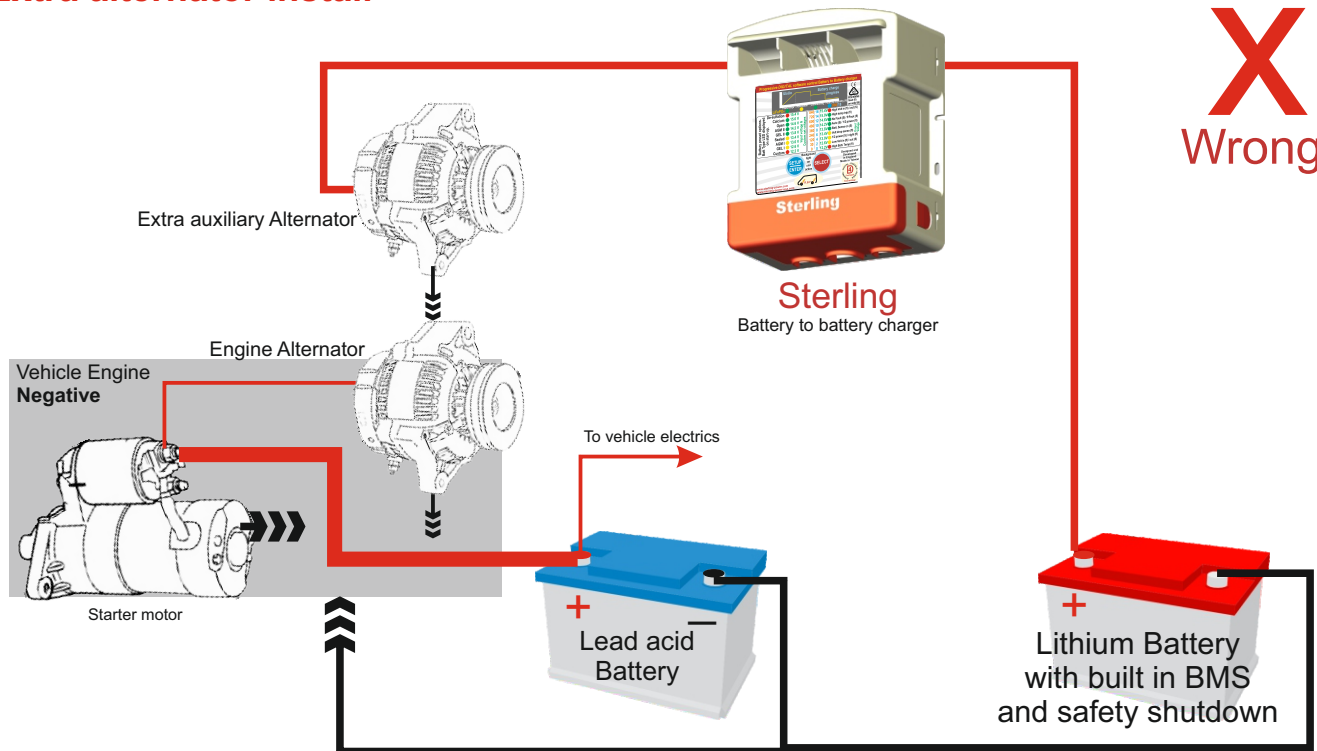

You may wish to add an extra alternator to feed the lithium battery bank without using the engine alternator's either because it is too small or you don't want the complexity (if it is for more power and you wish to combine the 2 alternators - then see overleaf). Essentially, you cannot feed an alternator directly into a battery to battery charger as an alternator will not work correctly and the battery to battery charger can be destroyed due to the alternator's erratic performance. The alternator needs a capacitor to settle its regulator down and behave correctly. You must fit a 12V Alternator direct output power Linearisation Device (ALD).

## Extra alternator install using a Sterling Power linearisation device (ALD)

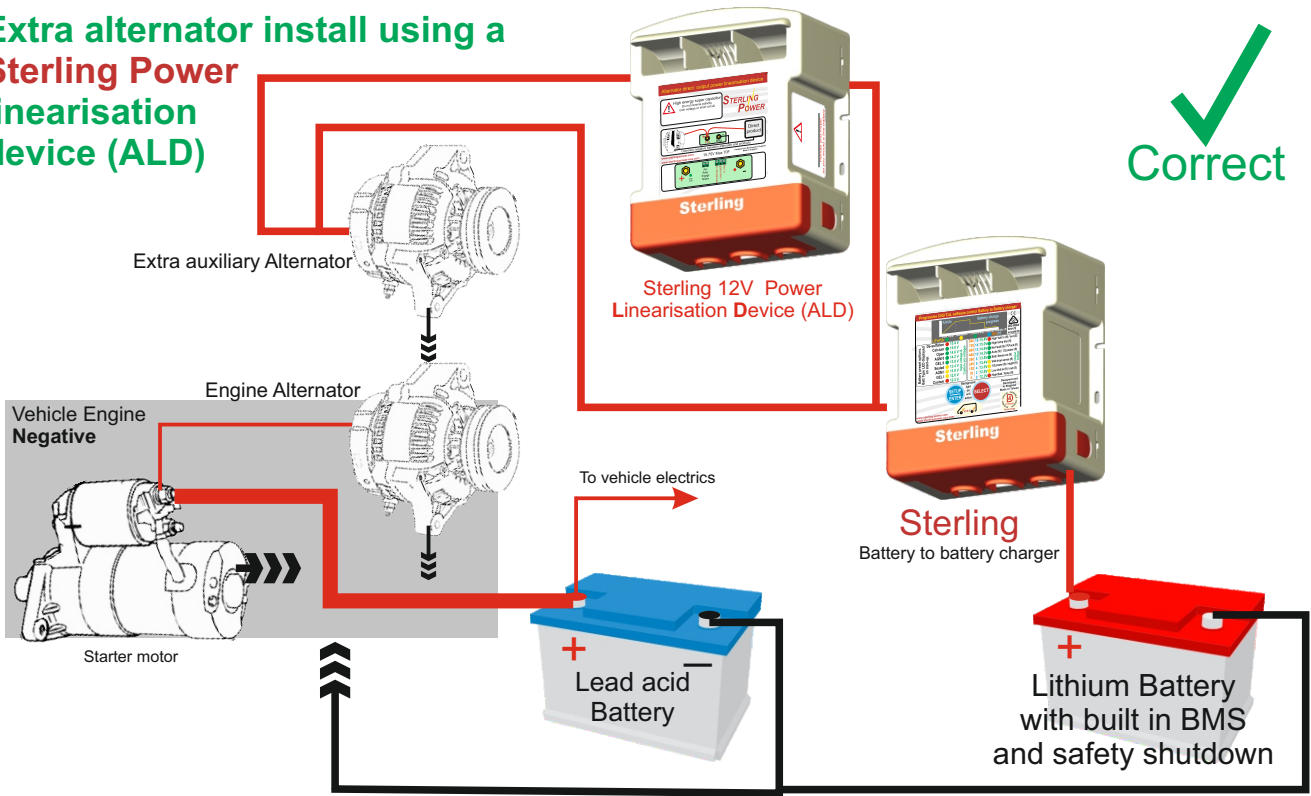

You may wish to add an extra alternator to feed the lithium battery bank without using the engine alternator's either because it is too small or you don't want the complexity (if it is for more power and you wish to combine the 2 alternators - then see overleaf). Essentially, you cannot feed an alternator directly into a battery to battery charger as an alternator will not work correctly and the battery to battery charger can be destroyed due to the alternator's erratic performance. The alternator needs a capacitor to settle its regulator down and behave correctly. You must fit a 12V Alternator direct output power Linearisation Device (ALD).

## Extra alternator install using both alternator

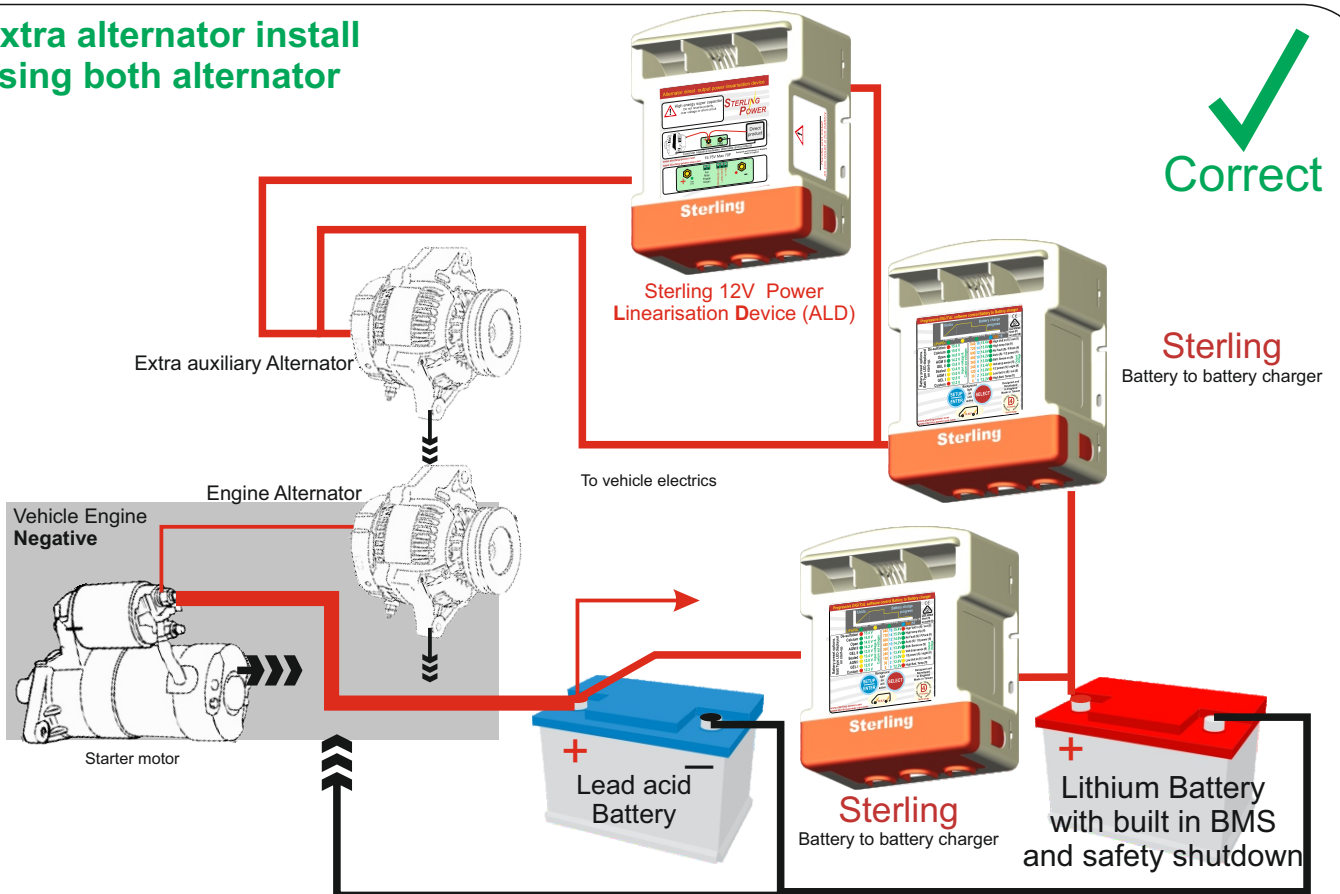

You may have wish to use the power from both alternators to charge a large lithium battery bank, simply do the maths and ensure the total C charge rating is not exceeded. In that event, then add as many battery to battery chargers as you see fit ensuring the total current is inside the C rating. You still need the 12V Alternator direct output power Linearisation Device (ALD) to stabilise the extra alternator, however, you can fit a battery to battery charger to the engine battery, as per normal.

**Safe operation conditions to obtain maximum performance and life from battery**

LifePO4 12V ( nominal ) . 100Ah and 120 Ah battery at 25 deg C Lithium Deep cycle battery  
 Maximum continuous charge rate 0.5C ( 50 amp hrs for 100 amp and 60 amp hrs fro 120 amp )  
 Maximum continuous discharge rate 1C ( 100 A for 100 Ah and 120 A for 120 Ah)  
 Interment discharge rate for 100 Ah battery 200 A for 30 sec and 120 Ah battery 240 A for 30 sec  
**Battery must be safely charged within units parameters a Battery to Battery charger must be used**  
 Max charge voltage 14.8 V  
 Recommended charge voltage 14.6 V  
 Float voltage 13.8 V  
 Cut off voltage 10V / cut off temperature 50 deg C  
 Charge Curve style CC/CV  
 Operational temperature -30 to 60 deg C  
 internal consumption : Operational = 10 ma , Dormant 0.1 ma

**Discharge performance at room temp.**

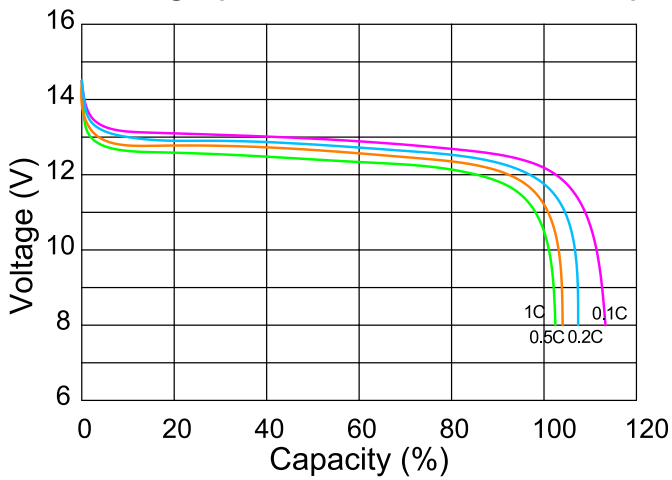

**Cycle life versus depth of discharge**

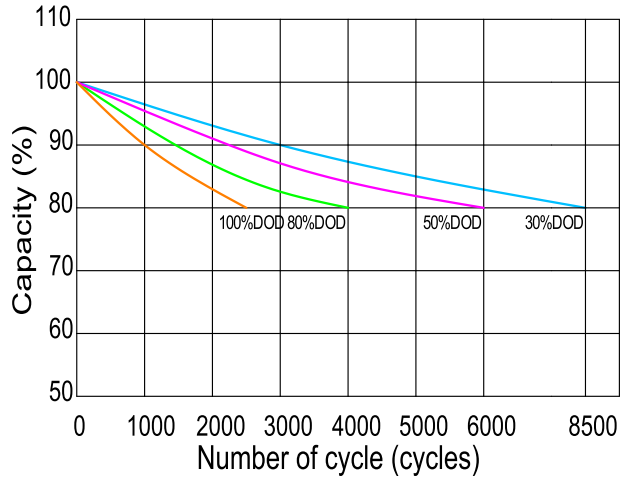

**Self-discharge characteristic**

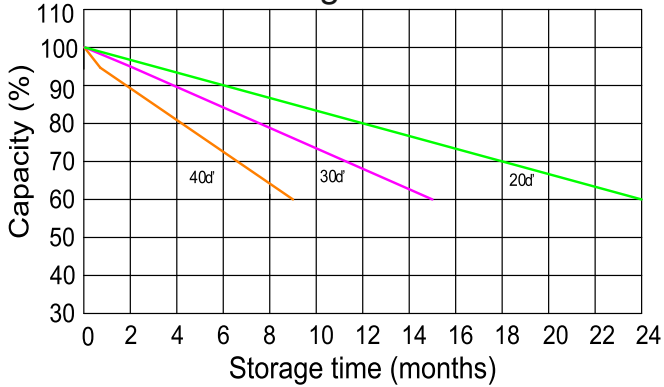

**Cycle life versus temperature**

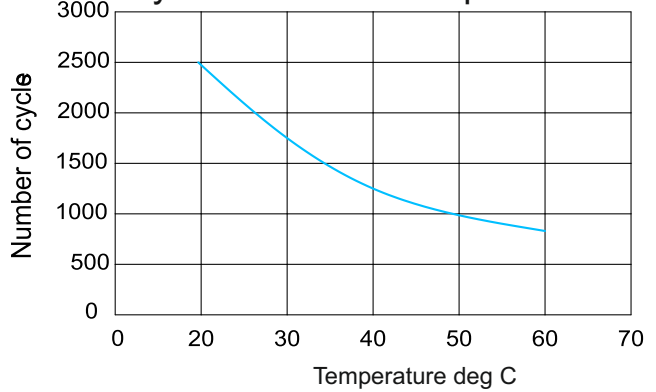

**Constant voltage charging characteristics**

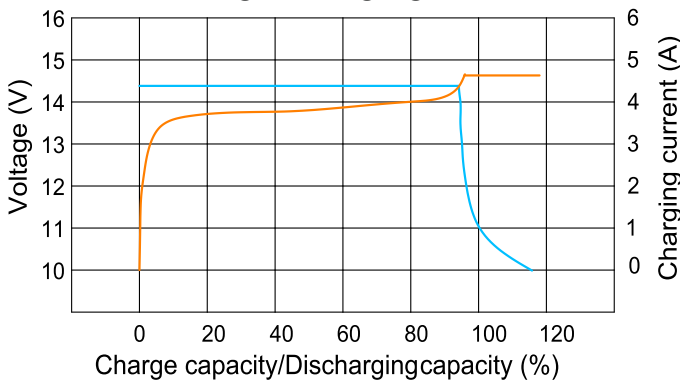

**Temperature effects on capacity**

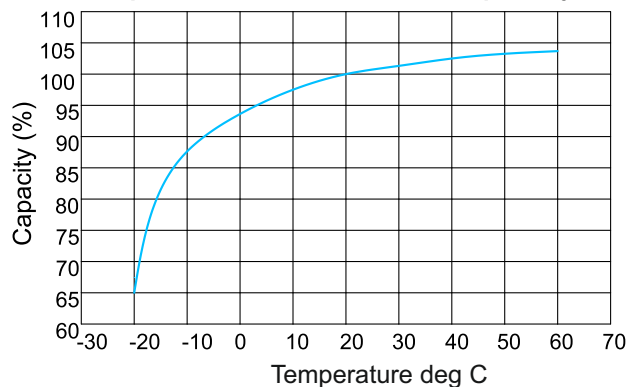



<b>Power and charge requirements per battery</b>			
	<b>100Ah</b>	<b>Both</b>	<b>120 Ah</b>
Nominal voltage		12.8V	
Charge voltage		14.6V	
Charged voltage		13.4V	
Cold cranking		N/A	
Continuous charge current	0.5C 50A		0.45C 50A
Continuous discharge current 1C	100A		120A
Intermittent discharge current 2C 30 sec	200A		240A
Capacity	100Ah		120Ah
Power capacity	1280W		1536W
<b>Size and weight</b>			
Weight	15KG		17KG
Size (mm)	323-173-H218		407-174-H208
Cell type		Prismatic	
<b>Performance</b>			
Usable Capacity	100Ah		120 Ah
Depth of discharge		100%	
Performance time 20A mins	300		360
Performance time 50A mins	120		144
<b>Modular build: Max Series connection up to 4 units = 48 V</b>			
<b>Max Parallel connection ( unlimited )</b>			
<b>Built in Battery Management System with extra safety features:</b>			
Built in Battery Management System ( Cell Balancing )			
Automatic battery production system		Internal	
Automatic low voltage disconnect	10V		20V
Automatic short circuit protection		Instant	
Automatic over voltage protection	15.5V		31V
Automatic fault recovery		yes	
Internal cell thermal safety fuse		yes	
Flame retardant electrolyte		yes	
Fire retardant plastic case		yes	
Length way circuit boards		yes	
Explosion proof stainless steel cells		yes	

› **Customer Service & Warranty**

**Your 100 % satisfaction is our goal.** We realise that every customer and circumstance is unique. If you have a problem, question, or comment please do not hesitate to contact us. We welcome you to contact us even after the warranty and return time has passed.

**Product Warranty:**

Each battery comes with a 5 year limited factory warranty.

- **The original receipt or proof of purchase must be submitted to claim warranty. If proof cannot be located a warranty is calculated from the date of manufacture.**
- **Our warranty covers manufacture and material defects. Damages caused by abuse, neglect, accident, alterations and improper use are not covered under our warranty.**
- **Warranty is null and void if damage occurs due to negligent repairs.**
- **Customer is responsible for inbound shipping costs of the product to AMPS.**
- **AMPS will ship the repaired or warranty replacement product back to the purchaser at the purchasers cost.**

If your order was damaged in transit or arrives with an error, please contact us ASAP so we may take care of the matter promptly and at no expense to you. This only applies for shipping which was undertaken by our company and does not apply for shipping organised by yourself. Please do not throw out any shipping or packaging materials.

All returns for any reason will require a proof of purchase with the purchase date. The proof of purchase must be sent with the returned shipment. If you have no proof of purchase call the vendor who supplied you and acquire the appropriate documentation.

To make a claim under warranty, call our customer care line at ( England 01905 771771). We will make the best effort to repair or replace the product, if found to be defective within the terms of the warranty. AMPS will ship the repaired or warranty replacement product back to the purchaser, if purchased from us.

Please review the documentation included with your purchase. Our warranty only covers orders purchased from AMPS. We cannot accept warranty claims from any other AMPS distributor. Purchase or other acceptance of the product shall be on the condition and agreement that AMPS Ltd shall not be liable for incidental or consequential damages of any kind. Additionally, AMPS neither assumes nor authorizes any person for any obligation or liability in connection with the sale of this product. This warranty is made in lieu of all other obligations or liabilities. This warranty provides you specific legal rights and you may also have other rights, which vary from state to state. This warranty is in lieu of all other, expressed or implied.