

**STERLING
POWER**

induction hobs

USER MANUAL



Induction Hob

MODEL: IHSBS

2800W Multi-featured / Power Sharing

Multi-functional

Left Hob 1500W (max)

Right Hob 1500W (max)

Combined power is 2800W *(fine for 13A 230VAC)*

Please spec your inverter respectively.

Table of Contents

Table of Contents	2
Section 1 Caution & Safeguards	3/4
Section 2 Working principle	4
Section 3 Selecting the Proper Cookware	5
Section 4 Product Configuration	6
Section 5 Operating Instructions	6/7/8
Section 6 Care & Maintenance	9/10
Section 7 Troubleshooting Guide	11
Section 8 Warning.....	12
Section 9 Frequently Asked Questions	13
Section 10 Customer Service and Warranty.....	14

Section 1 Caution & Safeguards

Read all instructions thoroughly before operating the induction cooker unit to avoid injury or damage to property or damage to the cooker itself from unsafe use.

Keep this User Manual as a handy reference.

Electrical Hazards

Observe the following cautions:

DO NOT

- SUBMERGE the unit or electrical cord in liquid, touch the unit with wet hands, or use in a wet outdoor environment.
- USE if cooker surface is cracked.
- OPERATE if the electrical cord is frayed or if wires are exposed.
- ALLOW the electrical cord to hang over the edge of a table or counter-top.
- MOVE or TUG the unit by pulling on the power cord.
- LEAVE cookware unattended on the cooker when the unit in use.

Electric shock hazard.

Only qualified experts may perform repair and maintenance work on the cooker.

Personal Safety

DO NOT

- TOUCH the cooker surface or cookware bottom for several minutes after using as both will be hot.
- MOVE the cooker unit while cooking or with cookware on the surface.
- LEAVE or PLACE any metal objects on the cooker surface other than authorized metal cookware or an Induction Interface Disk.
- USE the cooker on any metal surface as the surface could become hot.
- HEAT unopened cans of food. The cans could explode.
- USE IN or AROUND flammable or explosive environments.
- LEAVE children in the immediate vicinity or around the cooker while in use.
- Leave cooker or other objects on the cooker unattended when plugged in.

CAUTION: This cooker unit emits an electromagnetic field, therefore people with pacemakers should consult with their physician before using.

Product & Property Damage

To prevent damage to the cooker or surrounding area:

DO NOT

- HEAT empty containers on the cooker surface.
- PLACE any metal object other than cookware on the cooker surface.
- PLACE objects weighing more than 25 pounds on the cooker surface.
- BLOCK or OBSTRUCT the cool air inlet and fan.
- OPERATE cooker on flammable surfaces.
- WASH an induction cooker in a dishwasher.
- USE the cooker unit for anything other than its intended purpose.
- PLACE objects affected by a MAGNET, such as a credit card, radio, television, etc, near the unit while operating the cooker.
- SHARE a 230V, 13A electrical outlet with another electrical item.
- BLOCK the rear and sides for the unit-keep at least 4" from walls for proper ventilation when in use.

Section 2 Working principle

Induction cookers are a safe, advanced, efficient and economic cooking technology. It works by electromagnetic vibrations generating heat directly in the pan, rather than indirectly through heating the glass surface. The glass becomes hot only because the pan eventually warms it up.

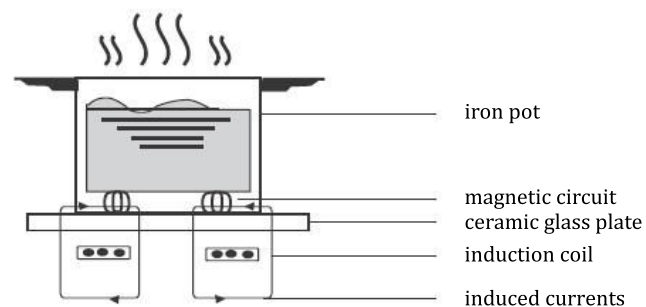

Section 3 SELECTING THE PROPER COOKWARE

Your induction cooker will not operate without the proper cookware. Read the following information in this section carefully to get the maximum efficiency from your unit. The rule of thumb for selecting cookware is if a magnet sticks to the cookware bottom, the cookware will work on your cooker. The bottom surface of the cookware must be made of ferrous magnetic material. The cookware must touch the cooker or rise no more than 1 inch above it.

Safety mechanism halts: The cooker may not operate (displays "E0" error code) if: The cookware does not have a flat bottom surface with a minimum bottom diameter of 4-6 inches.

The cooker may not operate if the pan bottom is made of material with a low ferrous magnetic content, even if a magnet sticks to the cookware bottom.

FRIENDLY COOKWARE

Material: Iron or stainless steel.

Shape: Bottom diameter about 12-20cm saucepan or square pot.

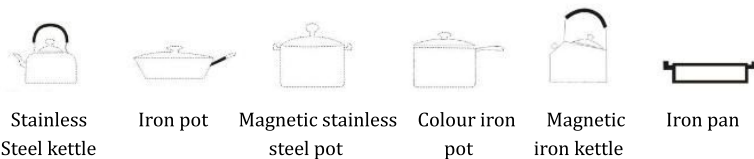

AND NON-FRIENDLY COOKWARE

Material: Non-iron metals, ceramics, glass cookware or utensils where the bottom is made of nonmagnetic copper or aluminum.

Shape: Bottom uneven, diameter less than 12cm.

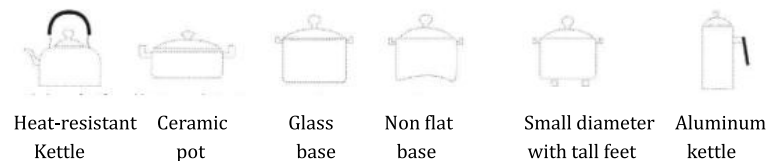

Section 4 Product Configuration

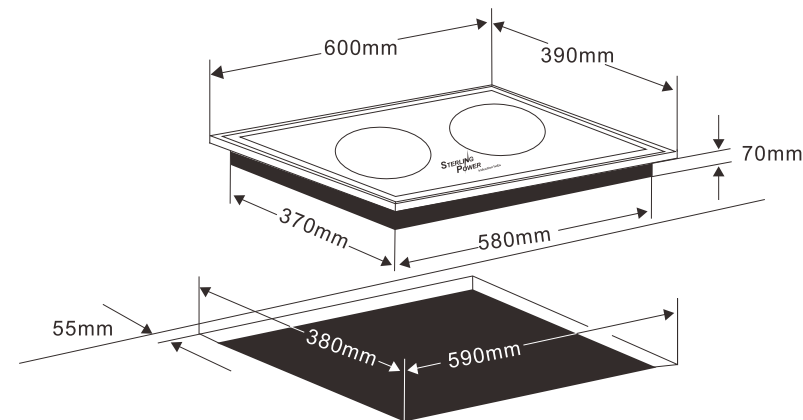

Section 5 Operating Instructions

[ON/OFF] 

After inserting the plug into the socket, a "Beep" will emit and all the indicators and display screen will flash for 1 second, the cooker will go to standby mode.

Put suitable cookware on the center of the cooking zone.







3. Press [On/Off] – the cooker shall start working directly. The cooker may have to have a function set before starting.

4. When the cooker is in use, you can stop operation by pressing [On/Off].

[LOCK]

1. Press  the display will show [Loc] representing that the cooker is locked.
2. During Lock mode, all buttons can't be adjusted.
3. To cancel it, press [Lock] and hold for 3 second, the cooker will be unlocked.



[TIMER]

1. Press  the display will show [0:00], user can press  or  key to set for the desired time.
2. Slight press of  or  key increases or decreases timer by 1minute.
3. Long press  or  key increases or decreases by 10 minutes.
4. After setting, the display will show desired power or temperature and remaining timer alternately.
5. When timer finish, the cooker will make a beep signal then stop working.
6. If you want to cancel timer, users can press the [On/Off] button.
7. After timer setting, user can change the power or temperature, this action won't cancel the timer setting.

COOKING FUNCTION:



Power:

When the unit is ON, Press the  key and 1000 shall display. This is the default power displaying 1000W.

It can be adjusted by pressing the  or  key to set the desired power level. It will turn off automatically if without any operation in 2hours.

- There are 9 power levels in total
- (200-400-600-800-1000-1200-1300-1400-1500W)
- To cancel this mode, press cooking modes or [On/Off] key to stop the operation.

Temperature:

Press again the MENU  key. The display will show [180 °C] representing the default temperature level is at 180 °C. There is an LED lit on TEMP. It can be adjusted by pressing the  or  key to set the desired power level. It will turn off automatically if without operation in 2 hours.

- There are 9 temperature levels in total
- (80-100-120-140-160-180-200-220-240°C)
- To cancel this mode, press [On/Off] key to stop the operation.

IHSBS(230V) Display power, actual power and Inverter recommendation 1500W hob x2									
P	P1	P2	P3	P4	P5	P6	P7	P8	P9
Display Power (W)	200	400	600	800	1000	1200	1300	1400	1500
Actual power (W)	830 pulse	830 pulse	830 pulse	836	953	1149	1300	1450	1500
Inverter power (W)	1000	1000	1000	1000	1000	1000	1600	1600	1600

For combined use we would recommend a 3000W inverter / 3500W Combi. Or, simply run 1x hob from a smaller inverter (1600W) and only run both hobs simultaneously when at a 13A 230V shore supply. When using both hobs at full power simultaneously the **maximum power draw** is 2800W. Therefore you shall not exceed the rating of the shore power supply.

If you wish to run both hobs from a smaller inverter please set the P level to a lower level so they power share within the rating of the inverter.

Power ratings and P settings for each hob

Section 6 CARE AND MAINTENANCE

1. Remove the power plug prior to cleaning the cooker. Do not attempt to clean until the surface cools down.
2. For cleaning, use a:
 - Soft or damp cloth for removing slight stains or spillages.
 - For grease or tough stains, blot with a clean damp cloth with neutral detergent.
3. When the fan is running it is possible for it to collect up dust and other particulates. Please clean it by soft brush or cotton bud regularly.
4. Avoid washing the cooker under direct water or you may cause damage..
5. Ensure the plug is properly embedded in the socket before operation
6. Refrain from pulling the power cord out directly during operation. To extend the life of the cooker press the "On/Off" button first, then pull out the power cord.
7. After turning the cooker off at the [ON/OFF] button, the fan may stay engaged for a short while. This is to cool everything down and it is better to unplug the cooker once it has finished cooling.
8. Please remove the plug from the socket and put the cooker away when done.



Please do not utilize 230V plugs that are 13A and below. Do not use multiplugs.



Ensure it is in an appropriate position and at least 12cm from a wall.



Do not utilise the induction cooker close to a gas hob, or any flammable gas supply



If heating canned food, please open the lid before cooking.



Do not use the induction cooker on iron or other conductive metal surfaces.



Do not heat empty pans, pots or kettles needlessly, as it may cause damage to the cooker or the utensils.



Clean the cooker and the fan regularly to ensure consistent results



Do not touch the surface while [ON], or shortly after use. May be hot.



DO NOT use if the power cable is damaged. Seek a professional.



As with all things cooking and heating, do not leave children unattended, for their safety.



If you have a medical pacemaker, consult a doctor before use.

Section 7 TROUBLESHOOTING GUIDE

During operations, if any error occurred, please check the following table before calling for service.

Issue	CHECK POINTS	REMEDY
No beeping sound or lights when [ON/OFF] is pressed.	Ensure plug is correctly plugged in, the cable is undamaged, and you have 230V going to the plug.	Ensure plugged in correctly. If cable is broken or still no connection, call Sterling.
Display shows 'E0'	Ensure the cookware is induction friendly	Replace with suitable cookware
	Check if the cookware is not placed centrally	Move the cookware to the center
	See if the cookware's base diameter is over 12cm	Replace with suitable cookware
	No or inapplicable cookware used	Ensure you are using correct cookware
Display shows 'E1'	Voltage $\leq 80VAC$	Call Sterling for help
Display shows 'E2'	Voltage $\geq 280VAC$	Call Sterling for help
Display shows 'E3'	Heat sensor overheat or short circuit.	Wait and restart after it turns cool
Display shows 'E4'	Heat sensor open circuit or not inserted.	Call Sterling for help
Display shows 'E5'	IGBT over heat/short circuit/fan not inserted.	Wait and restart after it turns cool
Display shows 'E6'	IGBT open circuit or not working.	Call Sterling for help

If error codes persist even after checking, please unplug the unit and call Sterling. To avoid danger and damage, do not disassemble or repair it by yourself unless you are a professional.

Section 8 *Warning*

Switch the induction cooker OFF in the instance that the cooker has cracked

1. Do not place the cooker in any place that is near flammable gases, or in an unvented and excessively hot closed area.
2. To reduce the chance of malfunction or damage, the cookers plug should be fit into an individual dedicated outlet. The rated electrical current should ideally not be less than 13A.
3. Place the cooker on a level surface and keep it ideally more than 12cm from any walls.
4. Do not submerge or immerse the cooker or power supply in water; or allow liquid to go into the frame or socket as it may cause a short circuit. Unplug before cleaning.
5. Do not cover fan vent with anything during cooking or use, as it may cause overheating.
6. To avoid potential pressurised explosions, ensure that canned or sealed foods have ventilation or an open before cooking.
7. If the cooker doesn't start working after basic adjustments, call Sterling. Do not take apart as this can cause risk to you and the product.
8. If there is a breach in the cable, do not consider using.
9. Do not attempt to heat the cooker through any other means.
10. Do not place any metal on or in the immediate vicinity of the cooker, as it may be heated.
11. Do not heat empty cooking utensils like kettles or pots, as they may crack.
12. When cleaning the fans or vents, ensure no dirt goes inside.
13. Do not touch the plate while the unit is working, to avoid getting burned.
14. Do not let children cook unmonitored with this unit, as they may get burned.
15. Those with pacemakers should check with their doctor before use.
16. Do not operate the cooker upon a gas stove.
17. Please do not place paper, cloth or anything, flammable or not, on top of the induction cooker while it is otherwise in use.
18. Do not place the cooker on carpet or spongy surfaces to avoid blocking the gas vent.
19. Avoid striking or dropping objects on the top of the cooker, as it can be cracked. If cracked, immediately discontinue use and call Sterling.
20. Do not touch the control panel or the internals with any sharp or metal implements.

Section 9 COMMONLY ASKED QUESTIONS

What are induction cooker advantages?

The induction cooker uses a standard 230V electrical power and plugs into a standard household electrical outlet or an inverter. Because Sterling Power hobs produce up to 2800W of power, they can be almost 50% more powerful than gas stoves and heat up to temperatures not commonly found in household kitchens.

Is induction cooking more efficient than gas?

With an 83% energy efficiency, induction cooking is more efficient than both electric and gas cookers. While gas burning cookers are only 30-35% efficient and cost approximately £1 per hour to operate, an induction cooker costs only £0.10 per hour to operate.

How safe is induction cooking?

Because there is no open flame or hot cooking element, the induction cooker creates heat only in the cookware. The cooker surface remains cool, except where the cookware bottom contacts the cooker surface.

How does electric and induction cooking differ?

Regular electric cooking elements use energy to heat the heating element and then through conduction, the heating is transferred to the cooking pan, where induction cooker place the electrical energy directly into the cookware. Resistance-type heating elements are very inefficient and are slow to respond. Induction cooking heating is swift, controllable and responsive.

Is it easy to use?

The rapid heating of the cookware makes all kinds of cooking fast and easy. Cleaning is easy too. With no open flame or heating element, food does not burn to the surface so you can just wipe the cooker surface clean with a damp towel.

SECTION 10 - Customer Service and Warranty

Your 100 % satisfaction is our goal. We realize that every customer and circumstance is unique. If you have a problem, question, or comment please do not hesitate to contact us. We welcome you to contact us even after the warranty and return time has passed.

Product Warranty:

Each product manufactured by Sterling Power comes with at least a 2 year limited factory warranty. Certain Products have a warranty period of time greater than 2 years. Each product is guaranteed against defects in material or workmanship from the date of purchase. At our discretion, we will repair or replace free of charge any defects in material or workmanship that fall within the warranty period of the Sterling Power product. The following conditions do apply:

- The original receipt or proof of purchase must be submitted to claim warranty. If proof cannot be located a warranty is calculated from the date of manufacture.
- Our warranty covers manufacture and material defects. Damages caused by abuse, neglect, accident, alterations and improper use are not covered under our warranty.
- Warranty is null and void if damage occurs due to negligent repairs.
- Customer is responsible for inbound shipping costs of the product to Sterling Power either in the USA or England.
- Sterling Power will ship the repaired or warranty replacement product back to the purchaser at their cost.

If your order was damaged in transit or arrives with an error, please contact us ASAP so we may take care of the matter promptly and at no expense to you. This only applies for shipping which was undertaken by our company and does not apply for shipping organised by yourself. Please do not throw out any shipping or packaging materials.

All returns for any reason will require a proof of purchase with the purchase date. The proof of purchase must be sent with the returned shipment. If you have no proof of purchase call the vendor who supplied you and acquire the appropriate documentation.

To make a claim under warranty, call our customer care line at (USA 1-(207)-226-3500, England 01905 771771). We will make the best effort to repair or replace the product, if found to be defective within the terms of the warranty. Sterling Power will ship the repaired or warranty replacement product back to the purchaser, if purchased from us.

Please review the documentation included with your purchase. Our warranty only covers orders purchased from Sterling Power. We cannot accept warranty claims from any other Sterling Power distributor. Purchase or other acceptance of the product shall be on the condition and agreement that Sterling Power USA LLC and Sterling Power LTD shall not be liable for incidental or consequential damages of any kind. Some states may not allow the exclusion or limitation of consequential damages, so, the above limitations may not apply to you. Additionally, Sterling Power USA and Sterling Power LTD neither assumes nor authorizes any person for any obligation or liability in connection with the sale of this product. This warranty is made in lieu of all other obligations or liabilities. This warranty provides you specific legal rights and you may also have other rights, which vary from state to state. This warranty is in lieu of all other, expressed or implied.