

# High Power Performance Alternators

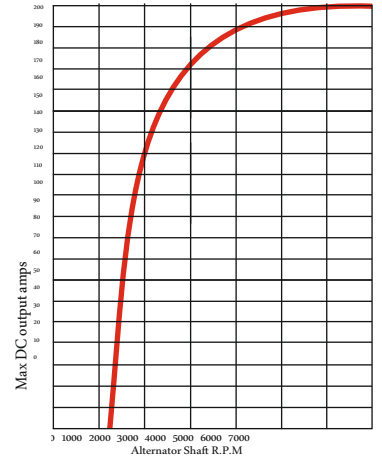

**12V / 200A**  
Good Low  
R.P.M  
Performance

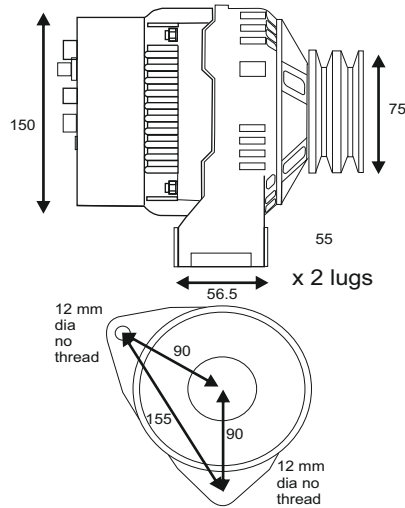

Description	SKU
12V 200A alternator with standard reg	AL12200
12V 200A alternator with standard & PDAR	AL12200PDAR

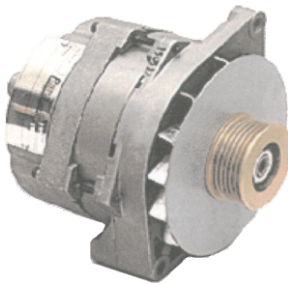

**12V / 145A**  
Good Low R.P.M  
Performance  
alternator supplied with  
multi V and twin V pulley  
photo shows multi V.

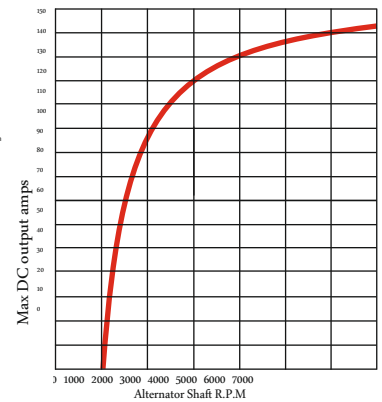
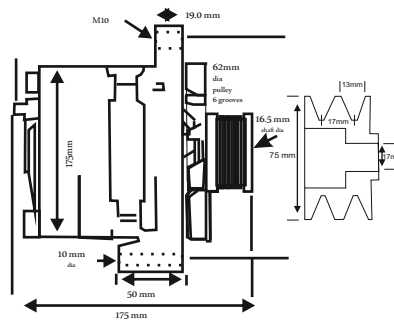

Description	SKU
12V 140A alternator with standard reg	AL12140
12V 140A alternator with standard & PDAR	AL12140PDAR

**24V / 140A**  
Good Low  
R.P.M Performance

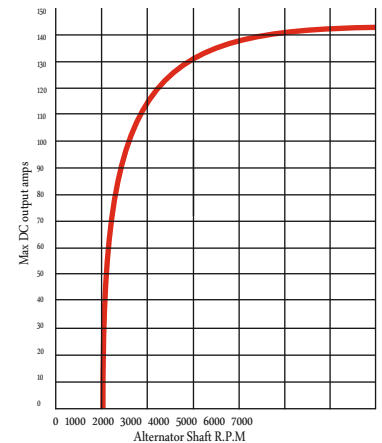
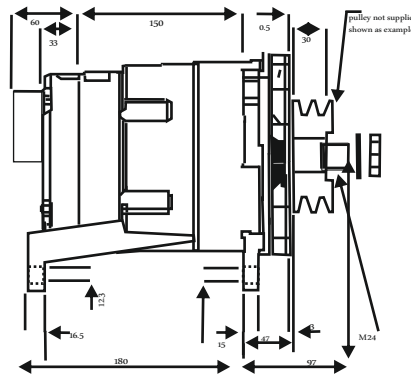

Description	SKU
24V 150A alternator with standard reg	AL24140
24V 150A alternator with standard & PDAR	AL12140PDAR

## Alternator Open Circuit Protection Device

Protects your alternator from **massive spikes** caused when a cable is loose or a fuse blows.

Simple safe emergency route for that spike to be discharged giving full protection to the alternators regulator

**IP67**

Alternator standard Switched path

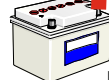

Emergency alternator route

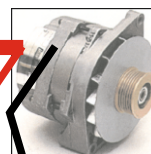

The protection device does not carry the main current of so only light wiring is required.

Unit works with any alternator or splitting device (12V or 24V).

Alternator protection device			
Voltage	L x W x D mm	Weight Kg	SKU
12V	90 x 90 x 60	0.25	APD12
24V	90 x 90 x 60	0.25	APD24