

CONTENTS

Pillow 2 Sconce (120V/240V)

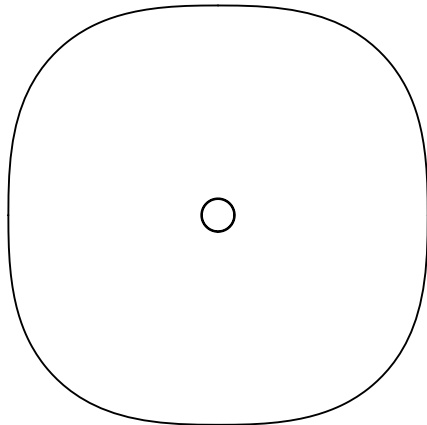

(x2) 8-32 J box Screw



(x7) Wago Connectors



Hex Key

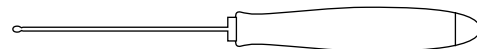

Driver

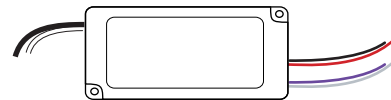

(x4) Toggle anchor
(240V only)

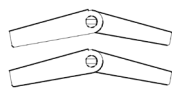

(x4) Metal screw
(240V only)



Driver Box
(240V only)

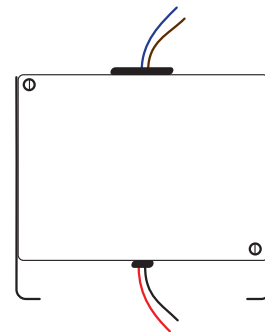

(x4) Wood screw
(240V only)



(x4) Long 8-32 screw
(240V only)



SAFETY INFORMATION

UL/Outdoor wet rated.

Maximum ambient temperature: 25°C

The light source contained in this luminaire shall only be replaced by the manufacturer or his service agent or a similar qualified person.

PILLOW 2 SCONCE (120V) | INSTALLATION

Note: Please contact a licensed electrician.

01. With the provided hex key (A), unscrew the set screw (B) from the fixture back plate (C), to release the crossbar with LED assembly (D).

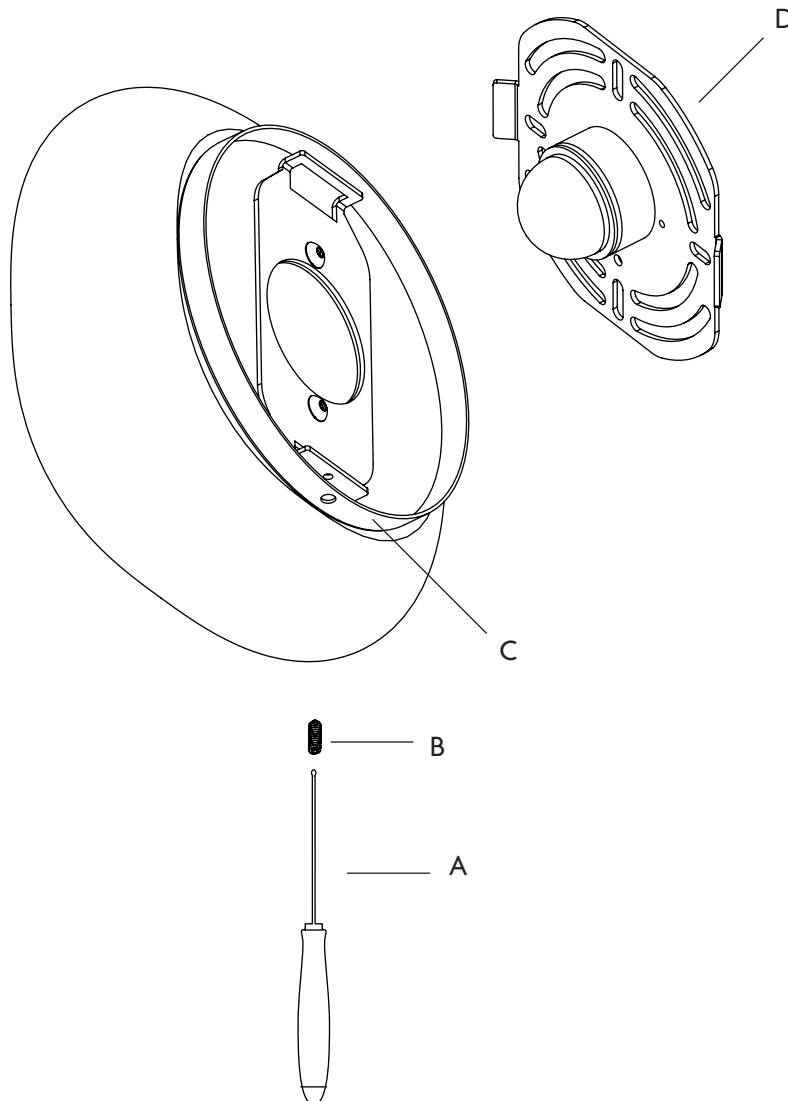

PILLOW 2 SCONCE (120V) | INSTALLATION

Note: Please contact a licensed electrician.

02. Take the LED driver (E), and connect the lead wires with the provided 2-port wago (F) from the J-box (G).
03. Fit the LED driver inside the J-box and tuck in the lead wires.

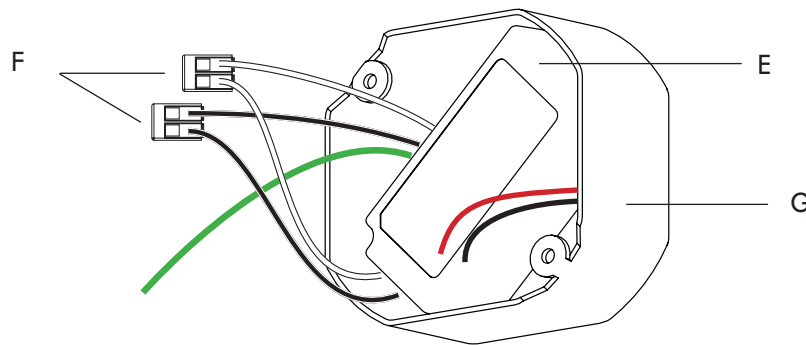

04. Bring the crossbar with LED assembly (D) up to the J-box (G), and make the ground wire connection using the provided 2-port wago (H).
05. Then make the low voltage wire connection with the provided 2-port wago (I).

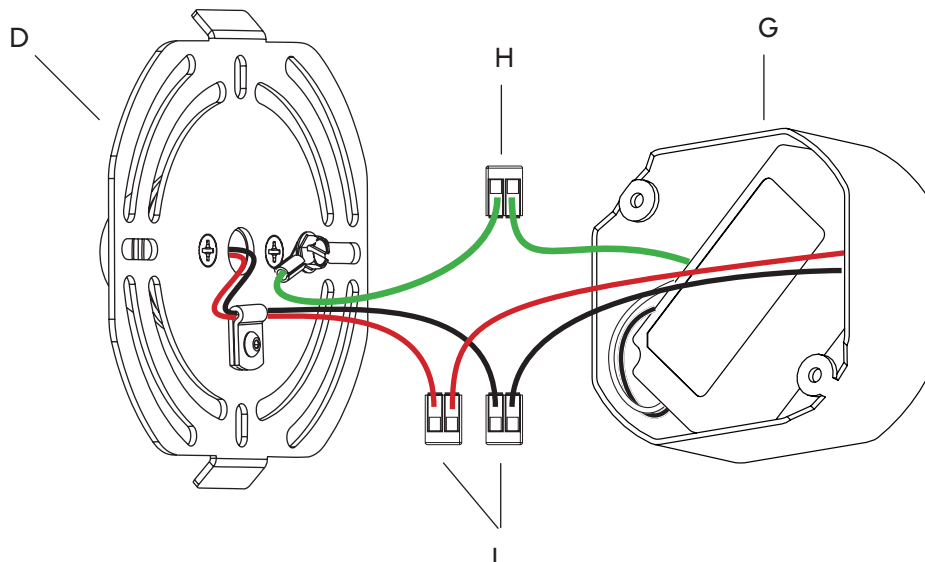

PILLOW 2 SCONCE (120V) | INSTALLATION

Note: Please contact a licensed electrician.

06. Tuck all the wires into the J-box (G), and secure the crossbar assembly (D) with two provided 8-32 screws (J).

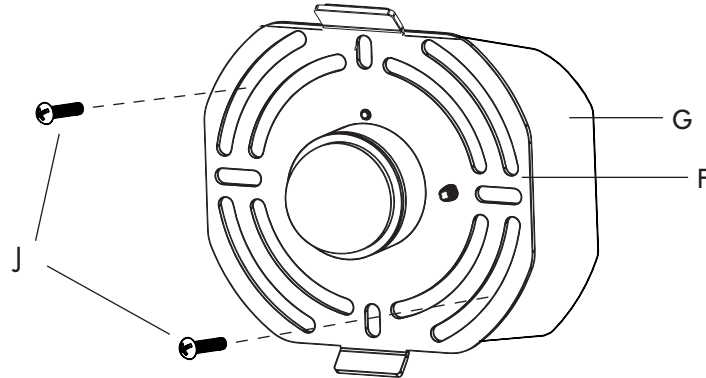

07. Hook the glass assembly (C) onto the french cleat of the crossbar assembly (D).

08. Using the hex key (A) secure the glass assembly with set screw (B).

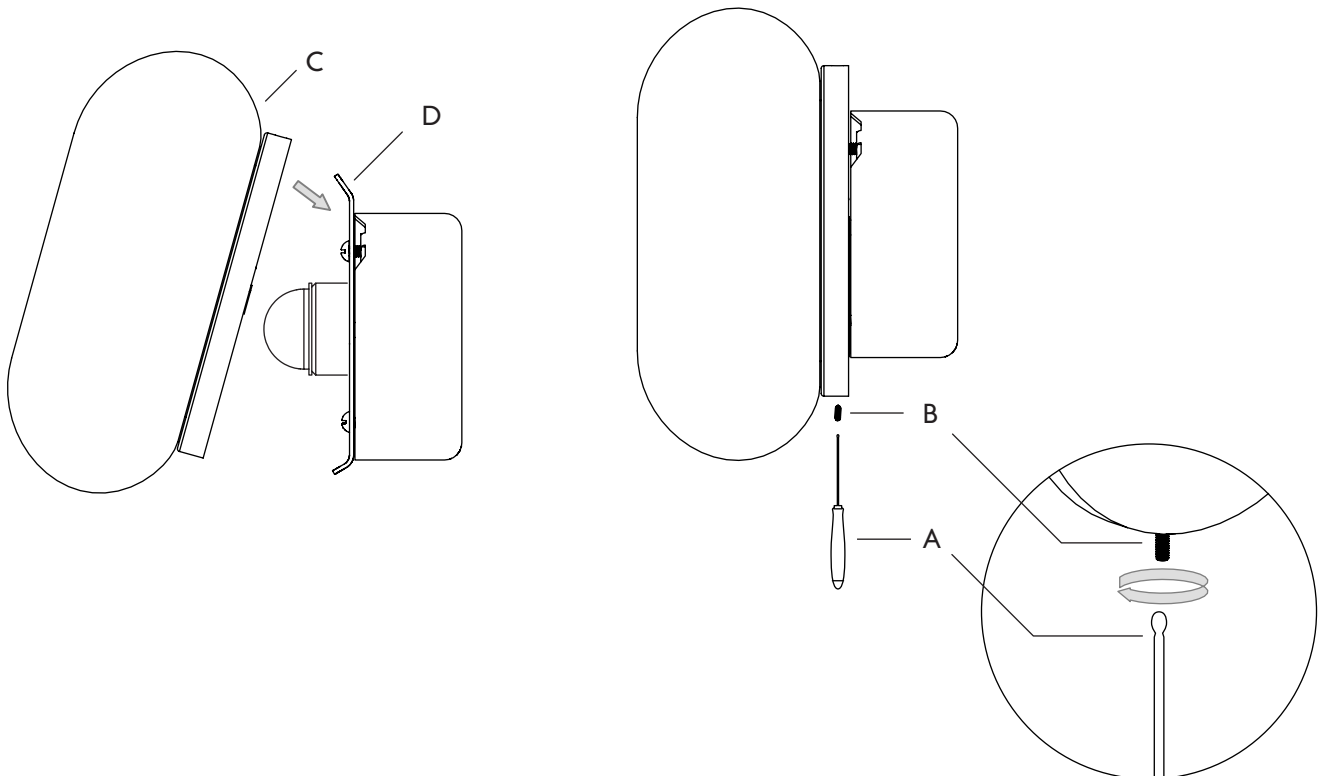

PILLOW 2 SCONCE (240V) | INSTALLATION

Note: Please contact a licensed electrician.

01. With the provided hex key (A), unscrew the set screw (B) from the fixture back plate (C), to release the crossbar with LED and 240V driver enclosure assembly (D).

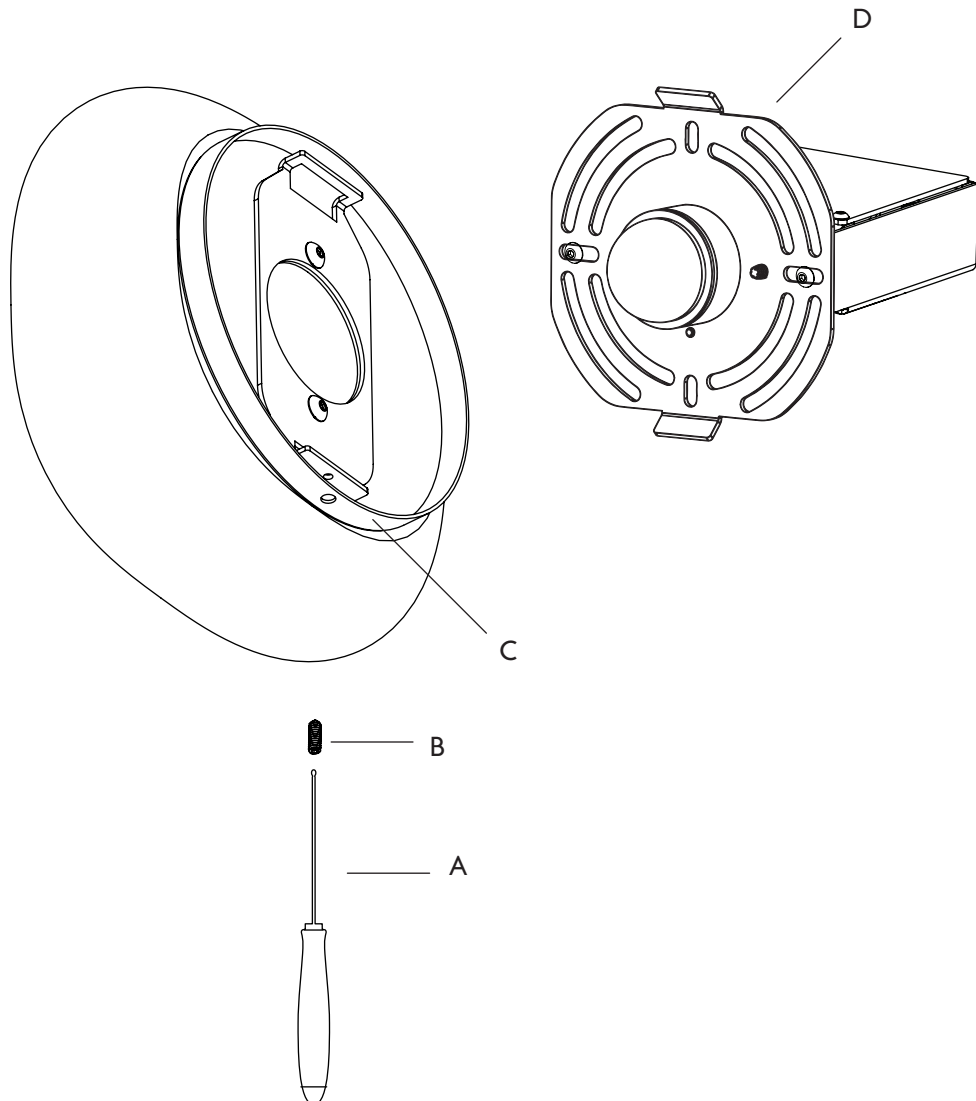

PILLOW 2 SCONCE (240V) | INSTALLATION

Note: Please contact a licensed electrician.

02. Connect the lead wires (E) to the power supply wires.
03. Mount the crossbar to the wall using the provided screws (F).

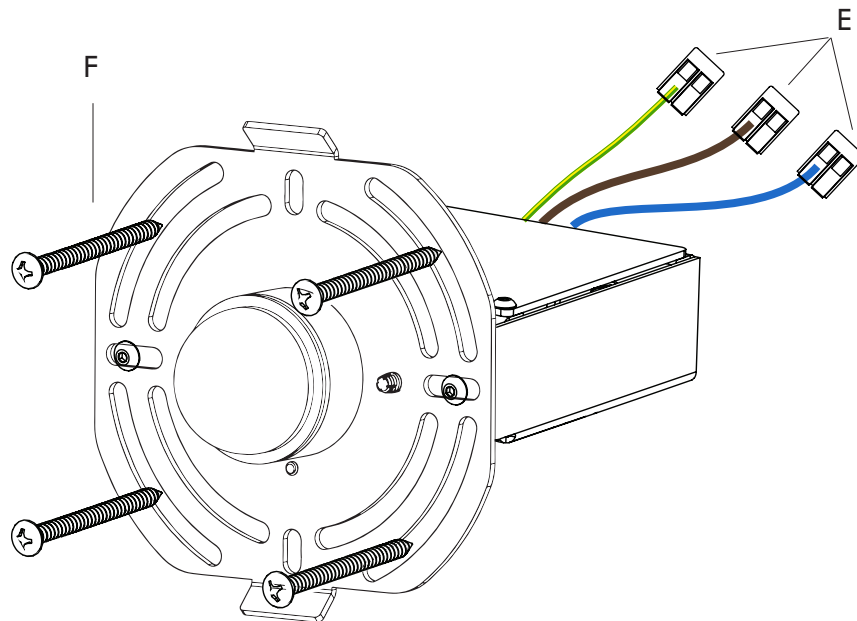

PILLOW 2 SCONCE (240V) | INSTALLATION

Note: Please contact a licensed electrician.

04. Hook the glass assembly (C) onto the french cleat of the crossbar assembly (D).

05. Using the hex key (A) secure the glass assembly with set screw (B).

