

CONTENTS

Updated 13DEC2019

(x1) Lighting Assembly

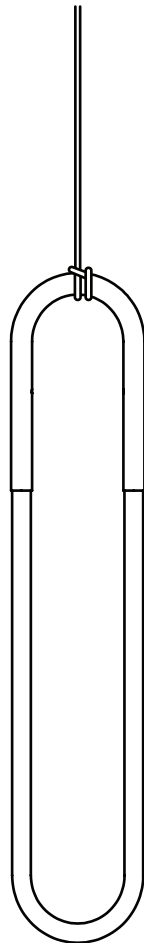

(x1) Crossbar assembly

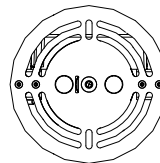

(x1) Canopy

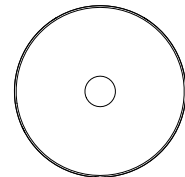

(x1) Canopy nut



(x2) 8-32 Screw

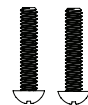

(x2) Toggle anchor
 On 240V fixtures only

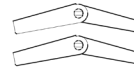

(x2) Long 8-32 screw
 On 240V fixtures only



(x2) Metal screw
 On 240V fixtures only

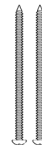

(x2) Wood screw
 On 240V fixtures only



SAFETY INFORMATION

Only suitable for direct mounting on non-combustible surfaces.
 Under no circumstances can Rudi Pendants be mounted on normally flammable surfaces.
 Suitable for dry, indoor use only.
 Maximum ambient temperatures: 25° C

RUDI INSTALLATION

Updated 02OCT2019

Note: Please contact a licensed electrician. Make sure all power is off before beginning installation

1. Route the main leads and ground wire from the ceiling through the crossbar (A), and connect the ground using the provided Wago (B).
2. Attach the crossbar (A) to the junction box (C) using the two provided 8-32 screws (D).
240V VERSION: Use the provided Toggle anchors and screws as necessary to secure the fixture to the ceiling.
3. Once the crossbar is secured, connect the main leads to the driver using the provided Wagos (E). Pay attention to the polarity.

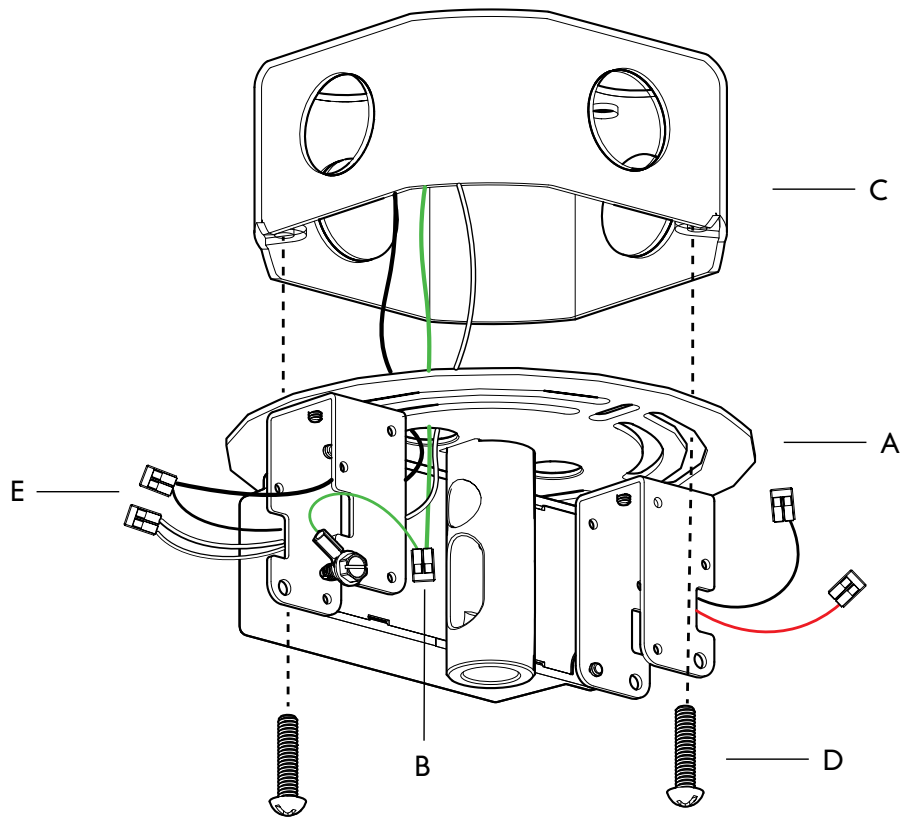

RUDI INSTALLATION

Updated 02OCT2019

Note: Please contact a licensed electrician. Make sure all power is off before beginning installation

4. Feed the drop cable (F) through the Canopy nut (G), Canopy (H) and route it in the crossbar assembly (A) as shown below

5. Connect the LED output wires from the driver to the fixture cable using the two provided Wago connectors (I). Please refer to table below for wire polarity.

Driver DC Output	Main Cord
BLACK	BLUE
RED	WHITE

6. Bring the canopy up and hold it in place by threading the Canopy nut (G) onto the crossbar (A).

