

## CONTENTS

Krane Large Ceiling Mount

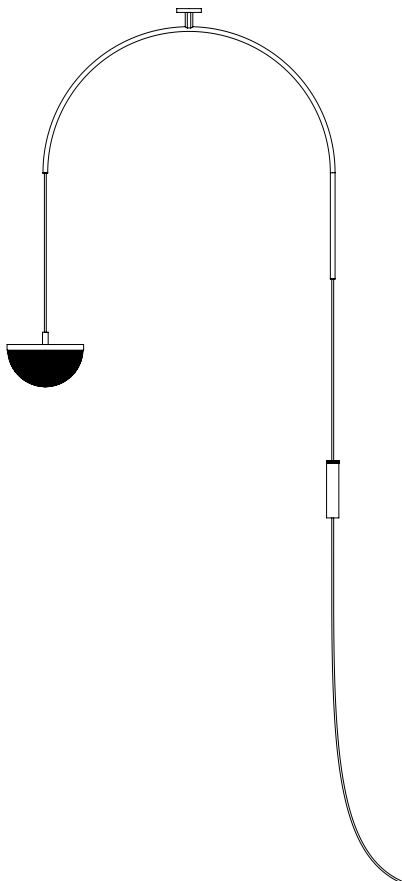

(x2) Toggle Anchors

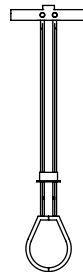

(x1) Anchor Template

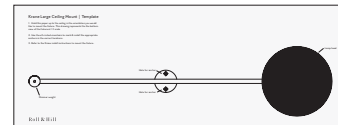

(x2) Concrete Anchors



(x2) Wood & (x2) Machine Screws

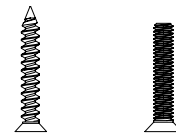

(x1) Krane Spool

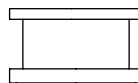

(x1) USB Driver

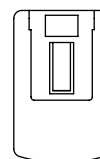

(x5) Adapters



## SAFETY INFORMATION

Only suitable for direct mounting on non-combustible surfaces.  
 Under no circumstances can Krane fixtures be mounted on normally flammable surfaces.  
 Suitable for dry, indoor use only.  
 Maximum ambient temperatures: 25° C

## KRANE CEILING MOUNT | INSTALLATION

---

*Note: Please contact a licensed electrician for installation.*

*Note: Fixture mounts with anchors, not to a junction box.*

1. Use provided Anchor Template to mark anchor locations on ceiling.
2. Install the appropriate anchors in their marked locations:

*For drywall ceilings: use toggle anchors with machine screws*

*For concrete or masonry ceilings: use concrete anchors with machine screws*

*For wood ceilings: use wood screws*

3. Hold the fixture (A) up to the ceiling and attach to the anchors/ceiling with provided screws (B).

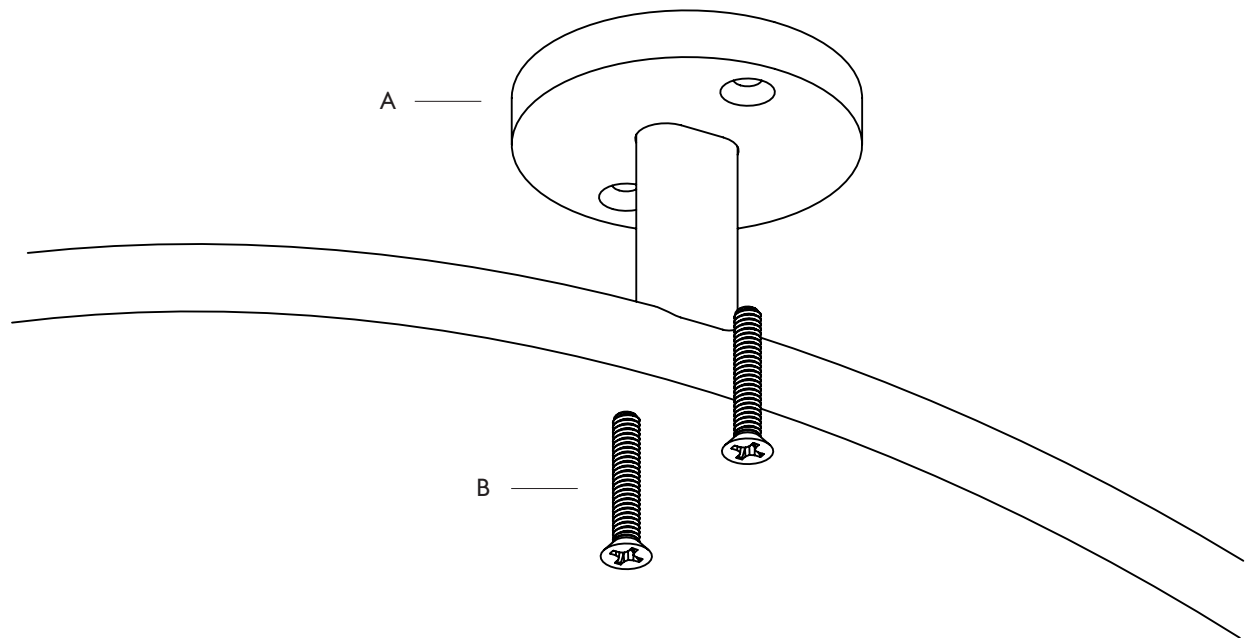

## KRANE CEILING MOUNT | INSTALLATION

---

*Note: Please contact a licensed electrician for installation.*

*Note: Fixture mounts with anchors, not to a junction box.*

4. Wrap excess cable tightly around spool (C). Make sure to leave slack between the spool and the fixture and between the spool and the wall outlet.

5. Move counterweight (D) to raise & lower the lamp head. Rotate the dimmer knob (E) to adjust the lamp's brightness.

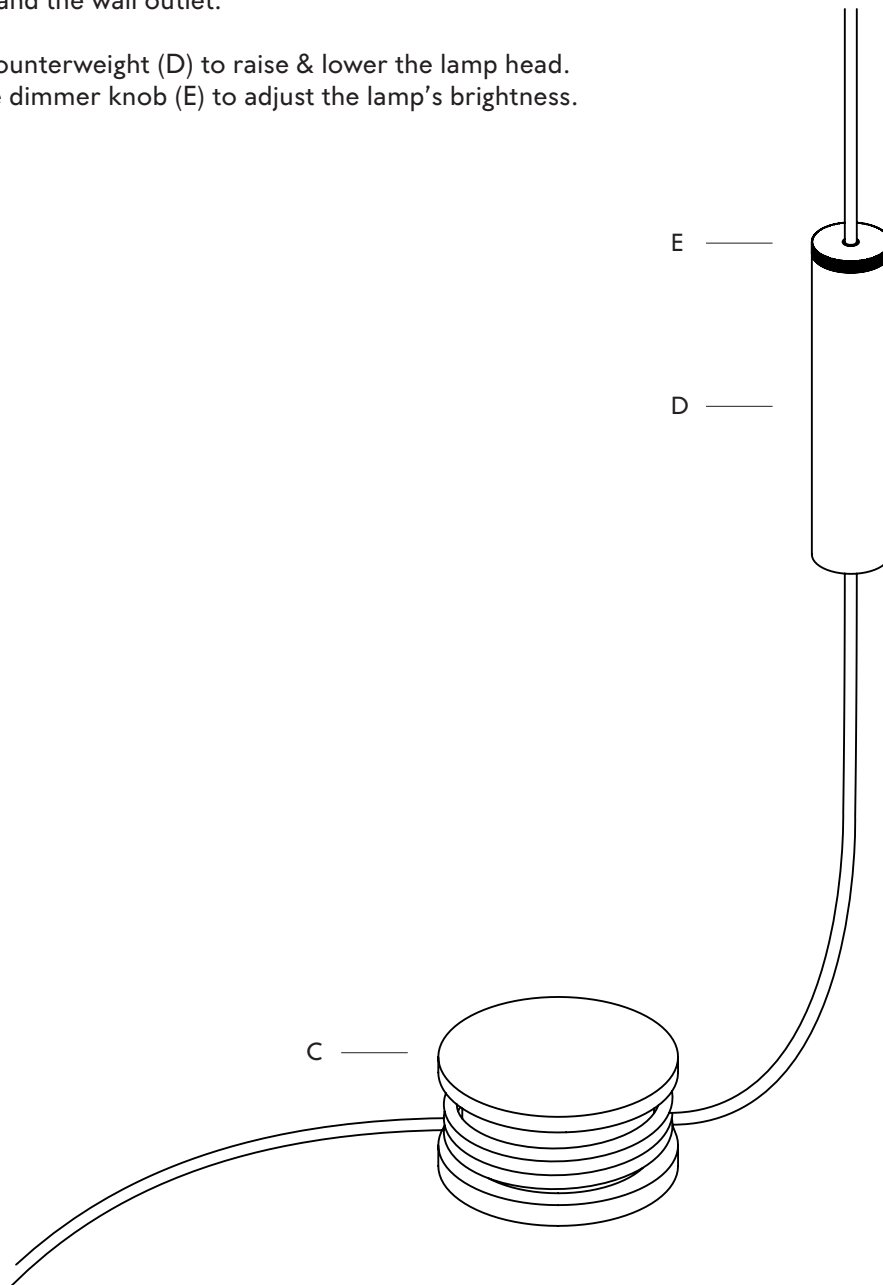

## KRANE CEILING MOUNT | INSTALLATION

---

6. Find the suitable driver adapter for your country's outlet type.

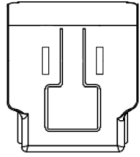

*North America*

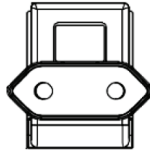

*Europe*

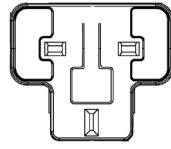

*United Kingdom*

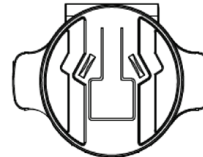

*Australia*

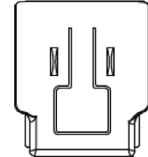

*China*

7. Slide driver adapter (F) into USB driver (G) until it clicks into place.

8. To remove a driver adapter, press on the flexible tab on the adapter and slide it out of the USB driver.

