

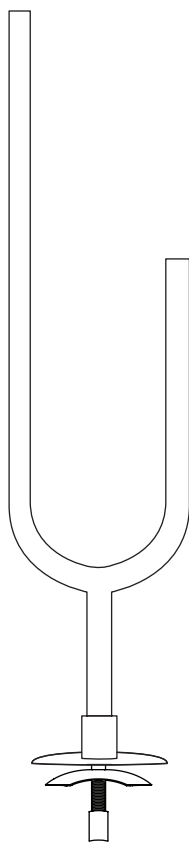

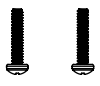



CONTENTS

<p>Koko pendant 2</p> 	<p>Wago Connector</p> 	<p>Wago Connector (x2)</p> 	
	<p>Glass</p> 	<p>Canopy</p> 	
	<p>Canopy finial</p> 	<p>Bulb</p> 	
	<p>Crossbar with nipple assembly</p> 		
	<p>(x2) Long 8-32 screw On 240V fixtures only</p> 	<p>(x2) Wood screw On 240V fixtures only</p> 	<p>(x2) Metal screw On 240V fixtures only</p> 

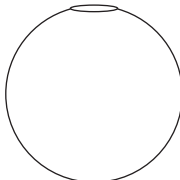
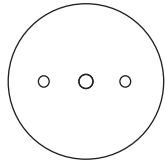
SAFETY INFORMATION

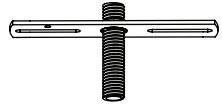
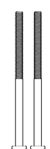
Only one light bulb per socket.
 Only suitable for direct mounting on non-combustible surfaces.
 Under no circumstances can Koko Pendant 2 be mounted on normally flammable surfaces.
 Suitable for dry, indoor use only.
 Maximum ambient temperatures: 25° C

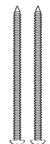
CEILING INSTALLATION | KOKO PENDANT 2

Note: Please contact a licensed electrician.

1. Feed the cord (A) from the fixture through the strain relief (B) and canopy (C) to the desired fixture drop length, then cut off the extra cord.
2. Then secure the cord by tightening the set screw (D) on the strain relief (B), and tie a nut (E) on the cord that is inside the canopy.

NOTE: Double check the desired fixture drop length before cutting off extra cord.
Only one cord is powered.

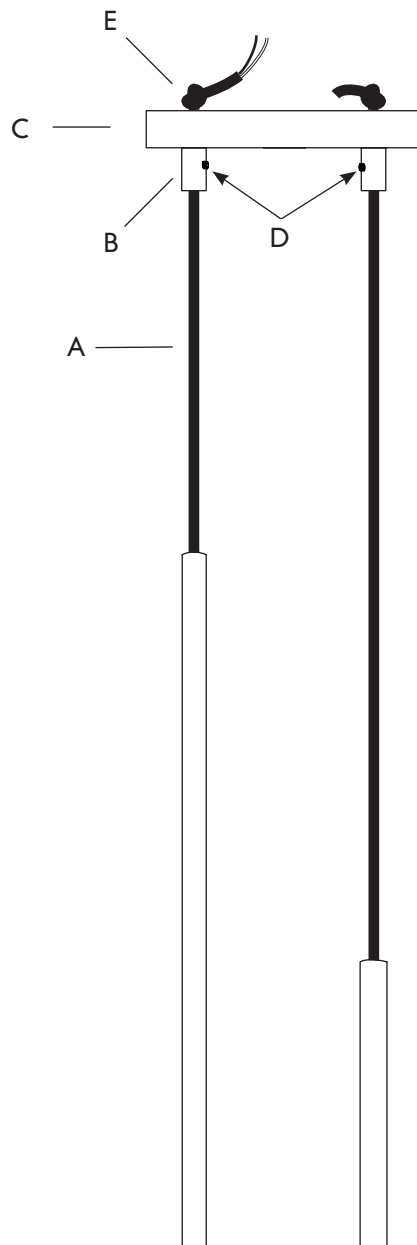

CEILING INSTALLATION | KOKO PENDANT 2

Note: Please contact a licensed electrician.

3. Attach the crossbar (F) to the J-box (G) using two screws (H).
4. Connect the ground wire to crossbar using the provided 2 port wago (I).
Be sure to pull out the lead wires.

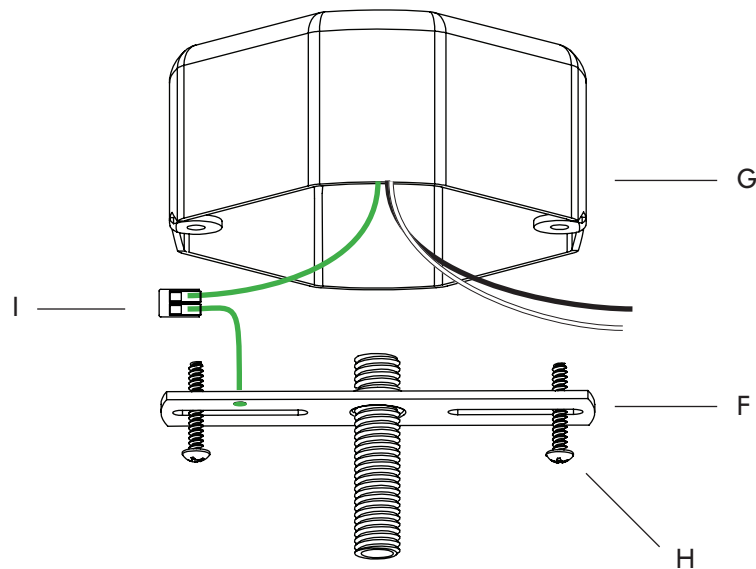

CEILING INSTALLATION | KOKO PENDANT 2

Note: Please contact a licensed electrician.

5. Raise the canopy (C) to the J-box (G), and make the electrical connection using the provided 2 port wagos (J).
6. Tuck the wires inside the canopy and fit the canopy over the nipple (K), then secure it with a finial (L).

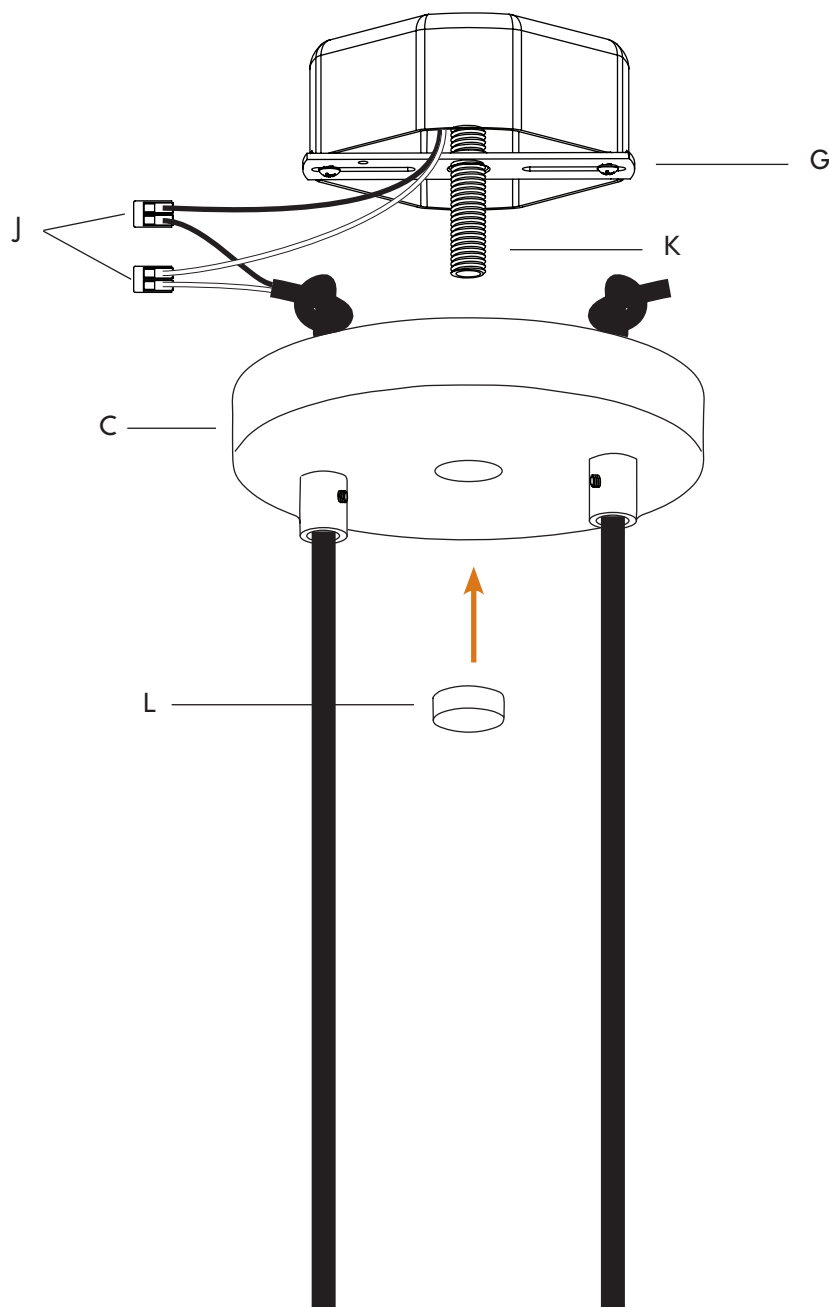

GLASS INSTALLATION

Note: Please contact a licensed electrician.

1. Sandwich the glass globe (A) around the socket fitter (B) and cap (C).
2. Gently tighten the sleeve (D) to hold the globe in place.

