

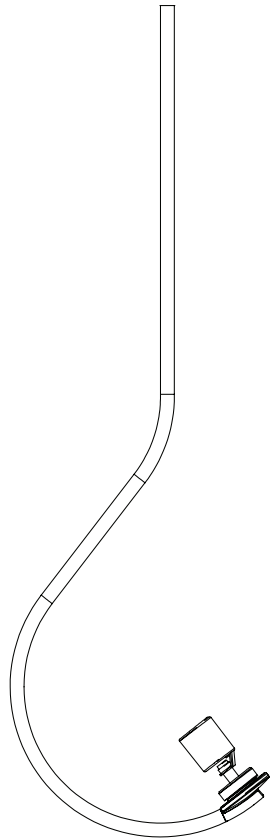

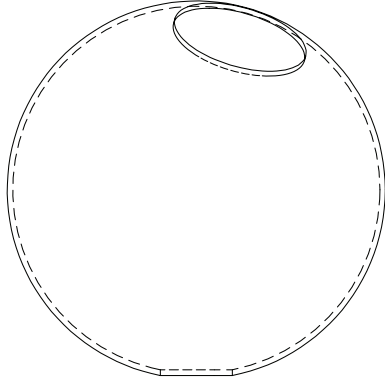

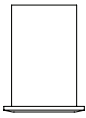
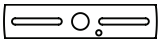
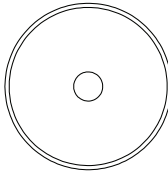

## CONTENTS

<p>Fiddlehead Pendant Tube</p> 	<p>Globe</p> 		<p>Collar</p> 
<p>Crossbar</p> 		<p>Canopy</p> 	<p>Plastic Washer</p> 
<p>Threaded Nipple</p> 		<p>A19 Bulb</p> 	<p>Hangstraight with Nut</p>  <p>Incandescent 120V (bulbs included)</p> <p>Incandescent 240V (bulbs not included)</p>
<p>Cover Tube and Threaded Rod</p> 			<p>8-32 Screws (2)</p> 

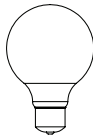
## SAFETY INFORMATION

Only one light bulb per socket.  
 Only suitable for direct mounting on non-combustible surfaces.  
 Under no circumstances can Fiddlehead Pendants be mounted on normally flammable surfaces.  
 Suitable for dry, indoor use only.  
 Maximum ambient temperatures: 25° C

## FIDDLEHEAD PENDANT | CEILING INSTALLATION

*Note: Please contact a licensed electrician.  
 Note: Do not use bulbs that exceed 60 watts.*

1. To customize the length of the provided 36-inch stem, cut cover tube to desired length. Then cut the inner threaded tube so that it remains 1/2" longer than the cover tube.

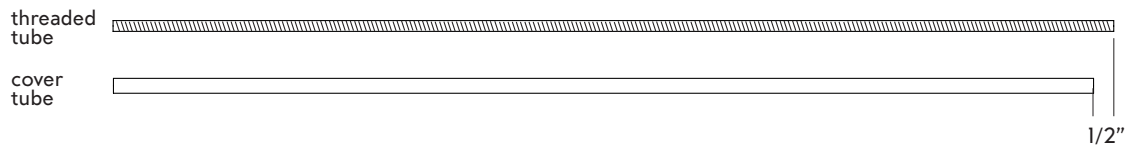

2. Install the crossbar (A) using #8-32 screws to junction box (B) in ceiling.
3. Attach the green ground wire to the crossbar with ground screw (C).
4. Screw the threaded tube (D) into the Fiddlehead fixture and feed the wires through the top. Slide the canopy down the stem from the top and screw into hangstraight at ceiling. Feed wires into the junction box, strip wires, and make electrical connections.
5. Conceal wires and connections inside junction box.

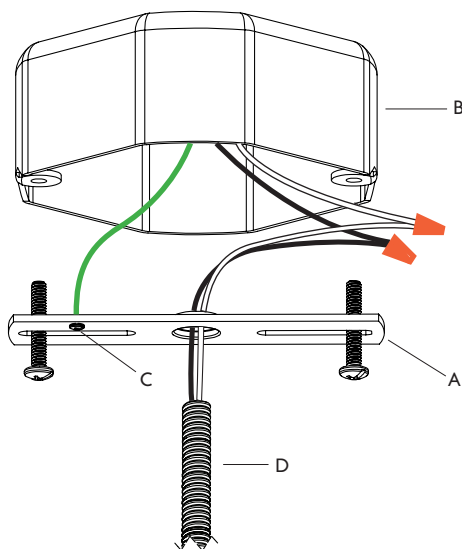

6. Raise the canopy (C) and the hang-straight nut (D) to the ceiling. Thread the nut onto the hangstraight, tightening the canopy flush to the ceiling.

**Note:** Follow instructions to install glass globe after securing fixture.

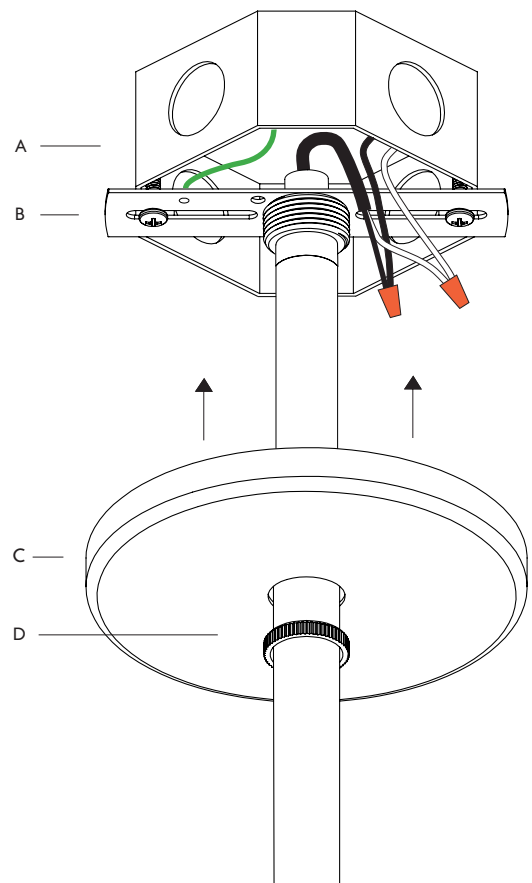

## INSTALLING THE GLASS GLOBE

---

*Note: If changing bulb, make sure to power off fixture and allow bulbs and metal arms to cool.*

1. To install the glass globe (A), hold fixture steady and carefully place the small hole of the globe over the socket (B).
2. Inside the globe, place the plastic washer (C) over the threaded socket (D) and insert the collar (E) through the large hole and thread on to socket (D).
3. To adjust the position of the globe lightly loosen the collar (E) and rotate so the large hole is to the left or right of the tube.
4. To install or change the bulb (F), reach through the large globe hole and screw into socket.

