

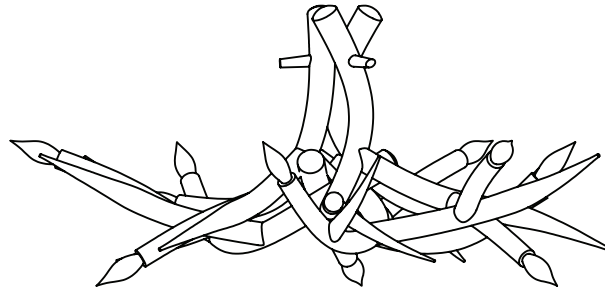

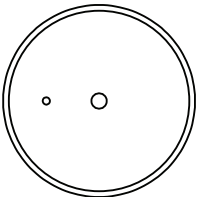

CONTENTS

Superordinate Antler Chandelier - 6 Antlers

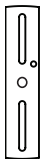

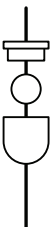
<p>Canopy</p> 	<p>Crossbar</p> 	<p>1/4-20 Threaded Rod</p> 
<p>Hanging Hardware</p> 	<p>E12 Bulb (12) 120V (bulbs included) 240V (bulbs not included)</p> 	<p>8-32 Screws (2)</p> 

SAFETY INFORMATION

Only one light bulb per socket.
 Only suitable for direct mounting on non-combustible surfaces.
 Under no circumstances can Superordinate Antler Fixtures be mounted on normally flammable surfaces.
 Suitable for dry, indoor use only.
 Maximum ambient temperatures: 25° C

SUPERORDINATE ANTLER CHANDELIER 4 AND 6 INSTALLATION

Note: Please contact a licensed electrician.

Note: Do not use bulbs that exceed 25 watts.

1. Install the crossbar using #8-32 screws to junction box (A). It is recommended to make the wire connections after installing the crossbar (B).
2. Once the crossbar is secure, tuck the connected wires into the Junction box (A) and raise the canopy (C). Tighten flush to ceiling with cable nut (D).

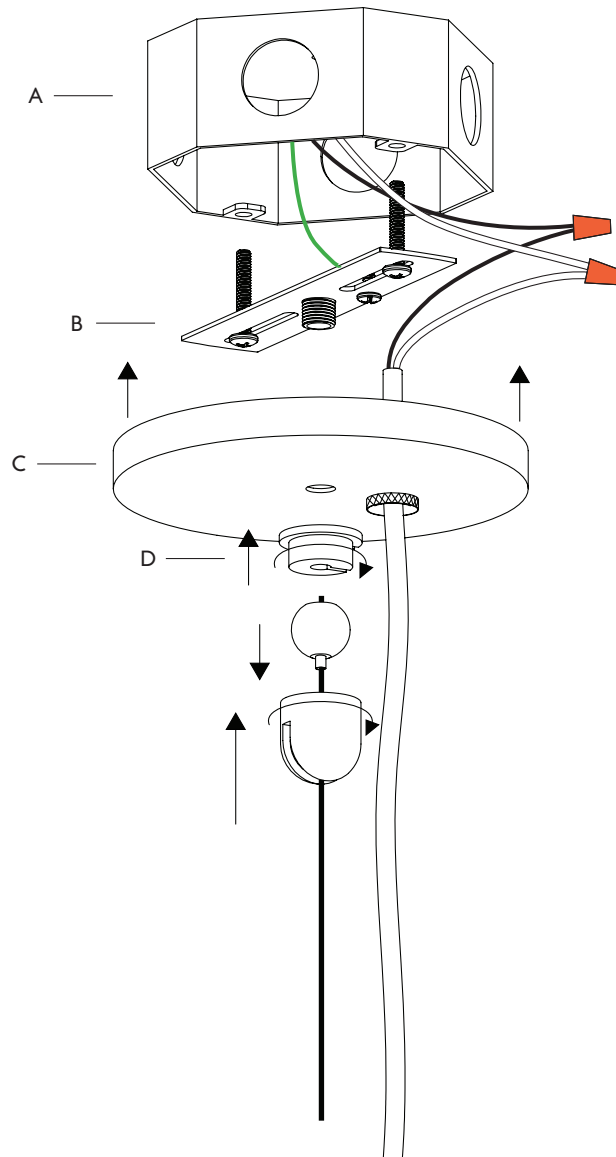

REPLACING BULB

Note: Make sure to power off fixture and allow bulbs and porcelain arms to cool.

1. To change the halogen E12 bulb (A) unscrew bulb from fixture (B) and replace.

