

ADAYO
M9920
Operating Instructions

SAFETY INFORMATION

Thank you for purchasing this product. Please read through these operating instructions so you will know how to operate your model properly. After you have finished reading the instructions, keep this manual in a safe place for future reference.

PRECAUTIONS

- Use only in a 12-volt DC negative-ground electrical system.
- Disconnect the vehicle's negative battery terminal while mounting and connecting the unit.
- When replacing the fuse, be sure to use one with an identical amperage rating.
- Using a fuse with a higher amperage rating may cause serious damage to the unit.
- DO NOT attempt to disassemble the unit. Laser beams from the optical pickup are dangerous to the eyes.
- Make sure those pins or other objects do not get inside the unit, they may cause malfunctions, or create safety hazards such as electrical shock or laser beam exposure.
- If you have parked the car for a long time in hot or cold weather, wait until the temperature in the car become normal before operating the unit.
- Keep the volume at a level at which you can hear outside warning sounds (horns sirens, etc.).
- Stop the car before performing any complicated operation.

CD NOTES

- Playing a defective or dusty CD can cause dropouts in sound.
- Handle the disc by holding its inner and outer edges. Do not touch the surface of the unlabeled side of the disc.
- Do not touch the unlabeled side.
- Do not attach any seal, label or data protection sheet to either side of a disc.
- Do not expose a CD to direct sunlight or excessive heat.
- Wipe a dirty CD from the center outward with a cleaning cloth.
- Never use solvents such as benzine or alcohol.
- This unit can not play 3-inch (8cm) CDs. Never insert a 3-inch CD contained in the adapter or an irregularly shaped CD. The unit may not be able to eject it, resulting in a malfunction.
- ★ In addition to ordinary CDs, this unit can play back a CD-R/CD-RW/MP3/UDF/CD-TEXT.

CONTENTS

Safety Information	1
Panel Controls	2
General Operation	3
Sound Setting	3
CD/MP3/WMA Operation	4
USB/SD/MMC MP3 Playback.....	5
Tuner Operation	7
Menu Function.....	7
Bluetooth Operations.....	8
Electrical Connections.....	10
Anti-Theft System	11
Installation Guide.....	11
Troubleshooting.....	12
Specifications	13

PANEL CONTROLS

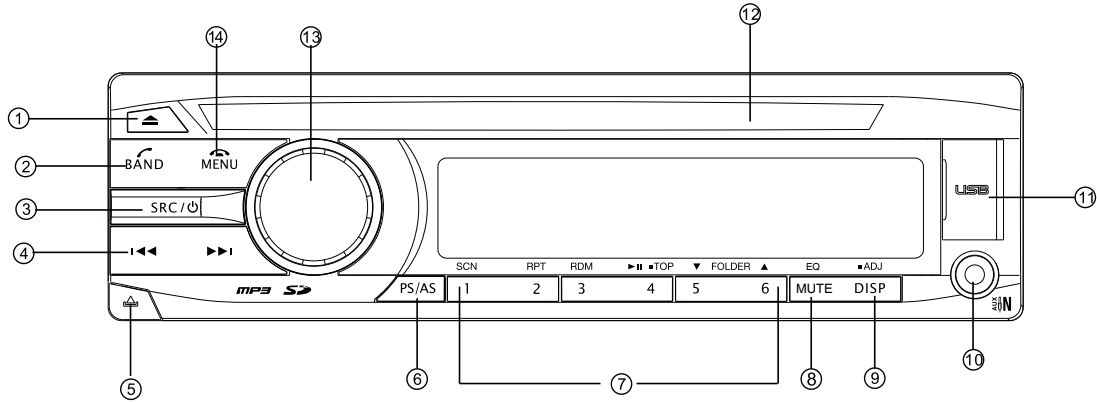

1. - Press to eject disc.
2. - Band switch:
FM1 -> FM2 -> FM3 -> AM1 -> AM2
- Dial / Receive / Transfer call (in BT mode)
3. Power / Toggle the audio source
4. - Previous / next track
- Search (long press)
5. - Unlock the front panel.
6. - Scan play / Preset scan
- Auto memory store (long press)
7. - Button 1: Scan play / Preset station 1
- Button 2: Repeat play / Preset station 2.
- Button 3: Random play / Preset station 3.

- Button 4: Play / Pause / Top play (long press) / Preset station 4.
- Button 5: Previous folder / Preset station 5.
10 tracks down (long press) /
- Button 6: Next folder / Preset station 6.
10 tracks up (long press) /
8. - MUTE
- Sound effect setting
9. - Display switch
- System setup (long press)
10. - Aux-in jack
11. - USB connector
12. - CD disc slot

13. - Adjust volume level / Confirm (press)
14. - MP3/WMA mode – Search function.
- CD mode – No function.
- RADIO mode – No function.
- AUX mode – No function.
- USB mode – Search function.
- BT mode – Reject / Terminate call.

GENERAL OPERATION

Power On/Off Button

Press the [SRC / ] button to turn the unit on when the vehicle ignition switch is on. Press and hold the button to turn the unit off.

Adjust Volume level

Rotate the volume knob to adjust volume level. Rotate it clockwise to increase and counterclockwise to decrease the volume.

Audio Mute

Press the [MUTE] button to mute the volume from the system. "MUTE" will appear on the display panel and the volume will be muted. Press the [MUTE] button again, or rotate or press the VOL/MENU control to return the volume level to the setting in use before the Mute function was activated.

Mode Button (SRC)

Press the [SRC / ] button to change between Radio, DISC (when disc is in), USB (when USB is connected), Card(when SD/MMC card is in), A2DP(when BT is connected) or AUX play.

Auxiliary Input

To access an auxiliary device:

1. Connect the portable audio player to the AUX interface on the front panel.
2. Press the [SRC / ] button to select Aux-In mode.

Press SRC again to cancel Aux-In mode and go to the next mode.



Display Selector (DISP)

This unit can display either the clock time or radio frequency/CD player functions. Ordinarily, the radio frequency or CD player track indication is displayed, but the unit will display the time when the DISP button is pressed. The time will display for approximately 5 seconds then return to the radio or CD player function display.



SOUND SETTING

Press and hold the [MUTE] button to enter sound effect setting mode. First press shows current EQ. Rotate the volume knob to changes BEAT EQ in this order:

OFF -> POP -> CLASSIC -> ROCK -> JAZZ -> CUSTOM

Rotate the volume knob to changes CUSTOM, and press the volume knob, then press [] or [] button to select it including: BAS-G -> TRE-G, rotate the volume knob to select a value.

BAS-G / TRE-G: (-7)- (+7)

Press and hold the [MUTE] button, then press [] or [] button to select USER preset including:

BALANCE -> FADER -> LOUD, rotate the volume knob to select a value.

BALANCE:LEFT 1-7->CENTER->RIGHT 1-7

FADER:FRONT 1-7->CENTER->REAR 1-7

LOUD: ON/OFF

CD/MP3/WMA OPERATIONS

This unit can play back MP3/WMA files

Notes:

If you play a WMA file with active DRM (Digital Rights Management), no audio is output.

To disable DRM (Digital Rights Management)

When using Windows Media Player 9/10/11, click on Tool -> Options -> Copy music tab, then under Copy settings, unclick the Check box for Copy protect music. Then, reconstruct files.

Personally constructed WMA files are used at your own responsibility.

Precautions when creating MP3/WMA file

Usable sampling rates and bit rates

1. MP3: Sampling rate 8 kHz-48 kHz, Bit rate 8 kbps-320 kbps / VBR
2. WMA: Bit rate 8 kbps-320 kbps

File extensions

1. Always add a file extension “.MP3”, “.WMA” to MP3, WMA file by using single byte letters. If you add a file extension other than specified or forget to add the file extension, the file cannot be played.
2. Files without MP3/WMA data will not play. The files will be played soundlessly if you attempt to play files without MP3/WMA data.

- * When VBR files are played, the play time display may differ the play location.
- * When MP3/WMA files are played, a little no sound part is caused between tunes.

Logical format (File system)

1. When writing MP3/WMA file on a CD-R disc or CD-RW disc, please select “ISO9660 level 1, 2 or Joliet or Romeo” or Apple ISO as the writing software format. Normal play may not be possible if the disc is recorded on another format.
2. The folder name and file name can be displayed as the title during MP3/WMA play but the title must be within 32 single byte alphabetical letters and numerals (including an extension).
3. Do not affix a name to a file inside a folder having the same name.

Folder structure

A disc with a folder having more than 8 hierarchical levels will not read.

Number of files or folders

1. Up to 999 files can be recognized per folder.
Up to 3000 files can be played.
2. Tracks are played in the order that they were recorded onto a disc. (Tracks may not always be played in the order displayed on the PC.)

3. Some noise may occur depending on the type of encoder software used while recording.

Eject function

Just pressing the [▲] button, ejects the disc even if the power to the unit was not turned on.

Notes:

- If you force a CD into before auto reloading, this can damage the CD.
- If a CD (12 cm) is left ejected for 15 seconds, the CD is automatically reloaded (Auto reload).

Listening to a disc already loaded in the unit

Press the [SRC / ⏮] button to select the CD/MP3/WMA mode.

When the unit enters the CD/MP3/WMA mode, play starts automatically.



Loading a CD

Insert a CD into the center of the CD SLOT with label facing up. The CD plays automatically after loading.

Notes:

- Never insert foreign objects into the CD SLOT.
- If the CD is not inserted easily, there may be another CD in the mechanism or the unit may require service.

CD/MP3/WMA OPERATIONS

- Discs without the  or  mark and CD-ROMs cannot be played by this unit.
- Some CD-R/CD-RW discs may not be usable.

Pausing play

1. Press the [4] button on the front panel or the [▶/II] button on the remote control to pause play.
“PAUSE” appears in the display.
2. Press the above button again to resume CD play.

Displaying CD titles

This unit can display title data for MP3/WMA disc.

When SCROLL is OFF, each time you press the [DISP] button to change the title display.

MP3/WMA disc

FILE --> FOLDER --> TITLE --> ARTIST --> ALBUM

Notes:

- If MP3/WMA disc is not input TAG, “NO TITLE” appears in the display.
- Only ASCII characters can be displayed in Tags.

Selecting a track

Track-up

1. Press the [▶▶] button to move to the beginning of the next track.
2. Each time you press the [▶▶] button, the track advances to the beginning of the next track.
3. For MP3/WMA disc, press and hold the [6] button (1 sec.) to move ahead to +10 tracks.

Track-down

1. Press the [◀◀] button to move back to the beginning of the current track.
2. Press the [◀◀] button twice to move back to the beginning of the previous track.
3. For MP3/WMA disc, press and hold the [5] button (1 sec.) to move back to -10 tracks.

Fast-forward/Fast-reverse

Fast-forward

Press and hold the [▶▶] button .

Fast-reverse

Press and hold the [◀◀] button .

* For MP3/WMA discs, it takes some time until the start of searching and between tracks. In addition, some error may occur in the play time.

Folder select

This function allows you to select a folder containing MP3/WMA files and start playing from the first track in the folder.

1. Press the [5] or [6] button.
Press the [5] button to move the previous folder. Press the [6] button to move the next folder.
2. To select a track, press the [◀◀] or [▶▶] button.

Search Function

Press the [MENU], then rotate the volume knob to choose FOLD SCH or TRK SCH.

Direct Song/File Access

1. Press the volume knob to enter the track list search mode.
2. Turn the volume knob to select a digit.
3. Press the volume knob to confirm entry and the tens digit will flash.
4. Turn the volume knob to select digit.
5. Repeat above steps to enter the hundreds and thousands digit, if necessary.
NOTE: The unit will only allow the selection of digits that correspond with the number of files on the media you are searching.
6. Once the track number appears on the screen, press the volume knob to play the selected song/file.

Searching Folders/Files

1. Press the volume knob to enter the folder list search mode.
2. Turn the volume knob to select a folder.
3. Press the volume knob to enter the file list search mode. And then the track list appears in the display.

CD/MP3/WMA OPERATIONS

4. Turn the volume knob to select a track.
 5. Press the volume knob to play.
- * When play back MP3 / WMA file, this function is performed in the current folder.

Top function

The top function resets the CD player to the first track of the disc. Press and hold the [4] button (1 sec.) to play the first track (track No. 1) on the disc.

* In case of MP3/WMA, the first track of the current folder will be played.

Other various play functions

Scan play

This function allows you to locate and play the first 10 seconds of all the tracks recorded on a disc.

Press the [1] button to perform scan play.

Repeat play

This function allows you to play the current track repeatedly or play a track currently being played in the MP3/WMA folder repeatedly.

CD:

1. Press the [2] button once or more until "RPT ON" appears on the LCD to perform repeat play.
2. Press [2] button repeatedly until "RPT OFF" appears on the LCD to cancel repeat playback.

USB/SD/MMC MP3 PLAYBACK

1. Loading SD/MMC Card
Insert the SD/MMC card into the slot.
The unit will play the music automatically and the LCD will show CARD.
2. Take out SD/MMC Card
Push SRC button and switch to non CARD mode, slightly press SD/MMC card, take out the card when it was popped out.
3. Loading USB equipment
Open the rubber cap, insert the USB into the connector and the unit play the music in the USB storer automatically, and the LCD will show USB.
4. Take out USB equipment
Push the SRC button and switch to non USB mode, then take off the USB storer, close the rubber cap.

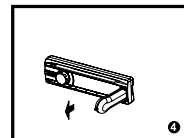
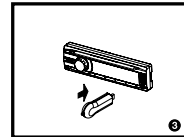
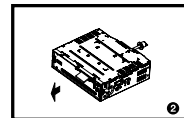
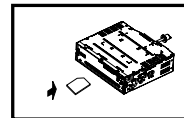

USB/SD/MMC Notes

USB functions (flash memory type) MP3 music play

1. SD/ MMC card support.
2. USB flash memory 2 in 1 (SD/MMC) support.
3. Fat 12/fat 16/fat 32 is possible.
4. File name : 32 byte/dir name : 32 byte/tag name : 32 byte
5. Tag (ID3 tag ver 2.0)
- title/artist/album : 32 byte support.
6. USB 1.1 support, USB 2.0 support (It can not support USB 2.0 speed. Just, get the same speed with USB 1.1).
Not all kinds of USB devices are compatible with the unit.

TUNER OPERATION

Band

During radio play, press the [BAND] button to choose between three FM, two AM bands. The indication "AM", "FM" appears on the display panel according to your selection.

Up Tuning

Press the seek up [▶▶] button to tune stations upward step-by-step. The current frequency will be shown in digital format on the display panel.

Press and hold the seek [▶▶] button to the next available station.

Down Tuning

Press the seek down [◀◀] button to tune stations downward step-by-step.

Press and hold the seek down [◀◀] button to the previous available station.

Auto Store

Press the [PS/AS] button to scan preset stations 1-6. Hold it to automatically select six strong stations and store them in the current band. The new stations replace stations already stored in that band.

MENU FUNCTION

At all mode, press and hold [DISP] button to enter system setup. Press [◀◀] or [▶▶] button to select options, rotate the volume knob to adjust.

CLOCK

Press the volume knob to enter clock setting mode, rotate the volume knob to set clock, press [◀◀] or [▶▶] button to select hour or minute, press and hold the volume knob to confirm.

DX/LO (RADIO mode)

Rotate the volume knob to choose radio local or distant at **RADIO** mode.

- **LO**: Only stations with strong signal can be received.
- **DX**: Stations with strong and weak signals can be received.

STEREO/MONO mode

Rotate the volume knob to choose FM stereo or mono.

SCROLL: ON/OFF

For track information that is longer than the display panel:

When SCROLL is ON, the LCD will display ID3 TAG information cyclicly, e.g: TRACK->FOLDER->FILE->ALBUM->TITLE->ARTIST->TRACK->...

When SCROLL is OFF, the LCD will display one of the ID3 TAG information, the default is TRACK, but user can adjust it to other ID3 TAG information by press [DISP] button.

SUBWOOFER ON/OFF

Rotate the volume knob to choose Sub-woofer on or off.

BEEP: ON/OFF

Rotate the volume knob to choose button beep sound ON or OFF.

12/24H

Rotate the volume knob to choose time format: 12 or 24 hour.

AUTO CON: ON/OFF

Automatically connects to the mobile phone that was last connected.

Rotate the [VOLUME] knob to choose AUTO CON ON or OFF.

BLUETOOTH OPERATIONS

The Bluetooth allows you to utilize your car's built-in audio system for wireless handsfree mobile phone communication or streaming music playback. Some Bluetooth mobile phones have the audio features, and some portable audio players support Bluetooth feature. This system can play audio data stored in a Bluetooth audio device. The car stereo with Bluetooth will be able to retrieve phonebook contacts, received call, dialed call, missed call, incoming calls, outgoing call and listen to music.

Notes:

- Do not leave the microphone of Bluetooth handsfree in the places with wind passing such as air outlet of the air conditioner, etc. This may cause a malfunction.
- If leave it in the places subjected to direct sun, high temperature can cause distortion, discoloration which may result in a malfunction.
- This system will not operate or may operate improperly with some Bluetooth audio players.
- Cannot guarantee the compatibility of all mobile phones together with unit.
- Audio playback will be set to the same volume level as set during telephone call. This might cause problems, if extreme volume level is set during telephone call.

Handsfree Operations

Pairing

1. Turn on Bluetooth function of your mobile phone.



2. Enter mobile phone's Bluetooth setup menu.
3. Search for new Bluetooth devices.
4. Select **M9920** from the pairing list on the mobile phone.
5. Enter "**0000**" as the password (The password default setting is "**0000**").
6. After pairing successfully, BT and HPF icons will light up.
A2DP icon will light up after A2DP connected.

Making a call

Operation from Bluetooth menu

Press the [SRC] button to switch the source to "A2DP". Press [MENU / ] button to select "DIAL NUM" to make outgoing call:

• Dial Number

1. Press the [VOLUME] knob to enter.
2. Rotate the [VOLUME] knob on the front panel to switch: "DIAL NUMBER".
3. Press the [VOLUME] knob to confirm the selection.
4. Rotate the [VOLUME] knob to select a number, press the knob to confirm and ready to input the next digit. Repeat the above until all numbers inputted.
5. Press the [BAND / ] button to dial.
6. Press [MENU / ] to terminate call.

• Transfer Call

You can switch Handsfree call and mobile phone call.

Press the [BAND / ] button during call.

• Answering a call

You can answer an incoming call by pressing the [BAND / ] button.

* Press the [MENU / ] button to reject an incoming call.

Audio Streaming Operations

What is audio streaming?

Audio streaming is a technique for transferring audio data such that it can be processed as a steady and continuous stream. Users can stream music from their external audio player to their car stereo wirelessly and listen to the tracks through the car's speakers. Please consult your nearest dealer for more information on the product of wireless audio streaming transmitter offered.

CAUTION

Please avoid operating your connected mobile phone while audio streaming as this may cause noise or sound choppy on the song playback.

Audio streaming may or may not resume after telephone interrupt as this is dependent on mobile phone.

System will always return to Radio mode if audio streaming is disconnected.

Note:

Be sure to read the chapter "Pairing" before proceeding.

BLUETOOTH OPERATIONS

Play / Pause a track

1. Push the [1] button to pause audio playback.
2. To resume audio playback, push the [1] knob again.

Selecting a track

Track-up

Press the [►►] button to move to the beginning of the next track.

Track-down

Press the [◀◀] button to move to the beginning of the previous track.

Note:

Playing order will depend on Bluetooth audio player. When [◀◀] button is pressed, some A2DP devices will restart the current track depends on the duration of playback.

During music streaming playback, “**A2DP**” will be shown on the display. When A2DP device is disconnected, “**BT MUSIC**” will be shown on the display. Some Bluetooth audio players may not have play / pause synchronized with this unit. Please make sure both device and main unit are in the same play / pause status in **BT MUSIC** mode.

ELECTRICAL CONNECTIONS

Wiring Diagram

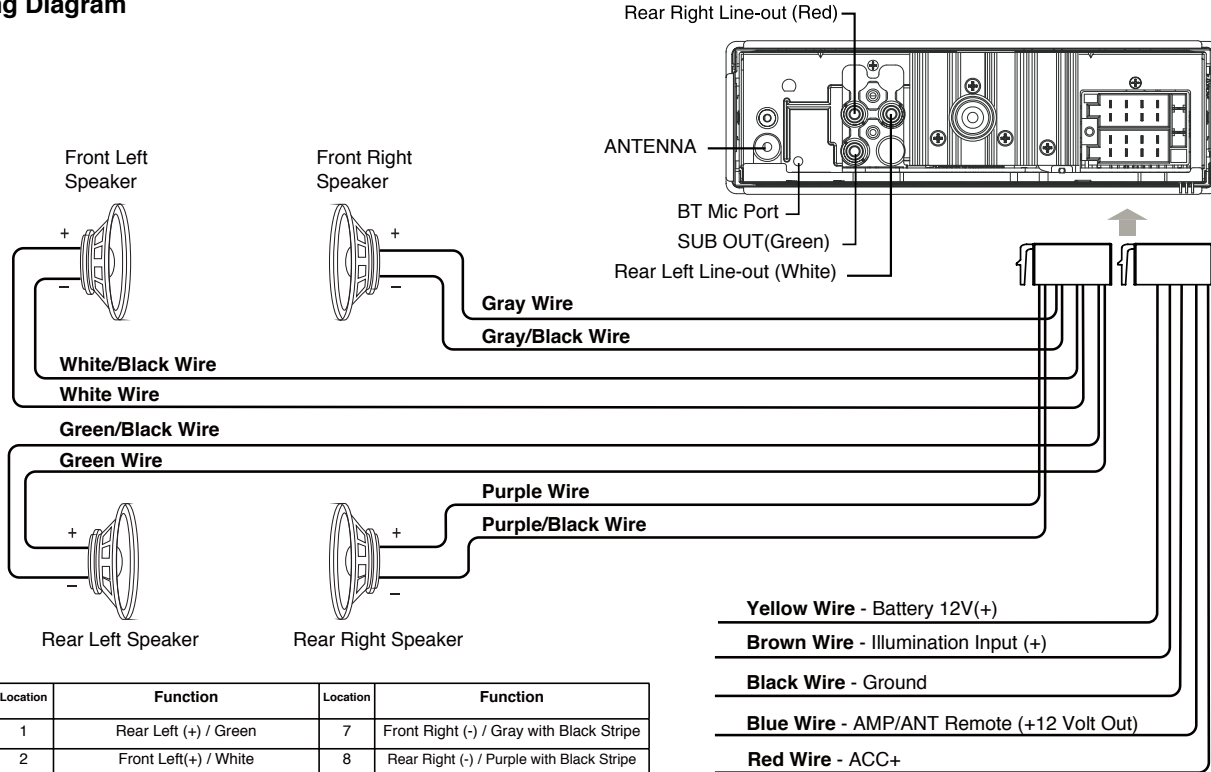

Location	Function	Location	Function
1	Rear Left (+) / Green	7	Front Right (-) / Gray with Black Stripe
2	Front Left(+) / White	8	Rear Right (-) / Purple with Black Stripe
3	Front Right (+) / Gray	9	ACC+ / Red
4	Rear Right (+) / Purple	10	Illumination / Brown
5	Rear Left (-) / Green with Black Stripe	11	Ground / Black
6	Front Left(-) / White with Black Stripe	12	Battery 12V(+) / Yellow

INSTALLATION GUIDE

Installation Opening

This unit can be installed in any dashboard having an opening as shown below. The dashboard should be 4.75mm - 5.56mm thick in order to be able to support the unit.

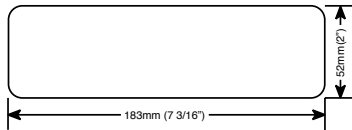

If the opening is too small, carefully cut or file as necessary until the sleeve easily slides into the opening. Do not force the sleeve into the opening or cause it to bend or bow. Check for sufficient space behind the dashboard for the unit chassis.

Reset

Press the RESET button with a ball point pen to reset the unit to the original status.

Note: Press the RESET button will erase the clock setting and stored stations.

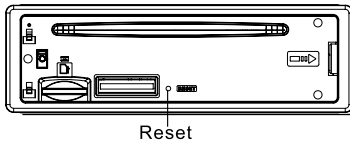

Installation Procedures

1. If relevant, remove any other audio system from the car.
2. Insert the mounting sleeve into the dashboard. Fix it firmly in place by folding down the metal tabs.
3. Perform the required electrical connections.
4. Then check that everything works before installing the main unit.
5. Remove the two screws on the top of the unit, otherwise, the CD will not work.
6. Install the car radio in the dashboard using the supplied screws (M5x6mm).
7. Attach the outer trim frame. If you are not sure how to install this unit correctly, contact a qualified technician.

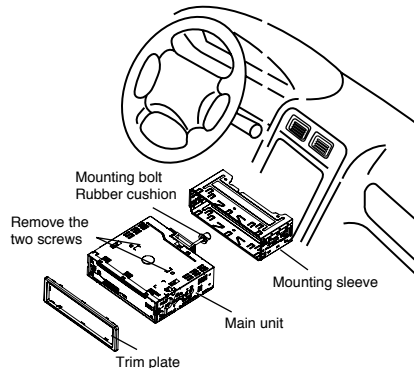

ANTI-THEFT SYSTEM

This unit is equipped with a detachable panel. Removing this panel makes the radio totally inoperable.

Remove the detachable panel

1. Press button.
2. Hold the part popped out and pull the panel out.
3. Gently press the button of the case and open the cover. Place the panel into the case and take it with you when you leave the car.

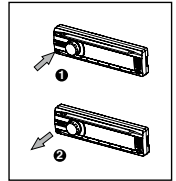

Install detachable panel

1. Fix right part of face plate in the panel slot of the unit.
2. Press down the left side of the face plate until it clicks into the panel slot.

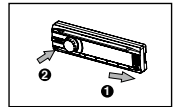

Remove the unit

1. Switch off the power of the unit.
2. Remove the panel and the trim plate.
3. Insert both Removal Keys into the hole on the front of the set until they lock.
4. Pull out the unit.

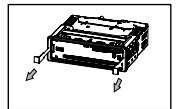

TROUBLESHOOTING

The following checklist can help you solve some problems which you may encounter when using the unit. Before consulting it, check the connections and follow the instructions in the user manual. Do not use the unit in abnormal condition, for example without sound, or with smoke or foul smell can cause fire or electric shock, immediately stop using it and call the store where you purchased it.

Problem	Possible cause	Solution
General		
The unit will not switch on.	Car ignition is not on. Cable is not properly connected. Fuse is burnt.	Turn your car key in the ignition. Check cable connection. Replace fuse with a new fuse of the same capacity.
No sound	Volume is set at minimum or the mute function is on.	Check the volume or switch the mute function off.
The unit or screen does not work normally.	The unit system is unstable.	Press the RESET button.
DISC mode		
The appliance will not play discs.	The disc is inserted incorrectly. The disc is dirty or damaged.	Disc must be inserted with the label side facing up. Clean the disc and check for damage. Try another disc.
Sound skips due to vibration.	Mounting angle is over 30°. Mounting is unstable.	Adjust mounting angle to less than 30°. Mount the unit securely with the supplied parts.
TUNER mode		
Unable to receive stations.	The antenna is not connected properly.	Connect the antenna properly.
Poor quality reception of radio station.	The antenna is not fully extended or it is broken.	Fully extend the antenna and if broken, replace it with a new one.
Preset stations are lost.	The battery cable is not properly connected.	Connect the permanent live on the unit to the permanent live on the vehicle.
USB/SD/MMC mode		
Unable to insert USB device or SD/MMC card.	The memory card or USB device has been inserted the wrong way round.	Insert it the other way around.
The USB device or SD/MMC card cannot be read.	NTFS format is not supported.	Check that the file system is in FAT or FAT32 format. Due to different formats, some models of storage devices or MP3 players may not be read.

SPECIFICATION

General	
Power supply:	12V DC (11V-16V)
	Test voltage 14.4V, negative ground
Maximum power output:	45Wx4 channels
Continuous power output:	20Wx4 channels (4Ω,10% T.H.D.)
Suitable speaker impedance:	4-8 ohm
Pre-Amp output voltage:	2.0V (CD play mode: 1KHz, 0 dB, 10 KΩ load)
Fuse:	15A
Dimensions(WxHxD):	178x50x166mm
Weight:	1.7kg
Aux-in:	≥ 300mV

FM Stereo Radio	
Frequency range:	87.5-107.9MHz
Usable sensitivity:	8 dBμ
Quieting sensitivity(S/N=50dB):	12 dBμ
Frequency response:	30Hz-15kHz
Stereo separation:	30dB (1kHz)
Image response ratio:	50dB
IF response ratio:	70dB
Signal/noise ratio:	55dB

(AM) Radio	
Frequency range:	530-1710 KHz
Usable sensitivity(S/N=20dB):	30 dBμ

Disc Player	
System:	Disc digital audio system
Frequency response:	20Hz-20kHz
Signal/noise ratio:	>80 dB
Total harmonic distortion:	Less than 0.20% (1kHz)
Wow and flutter:	Below measurable limits
Channel separation:	>55 dB

Note: Specifications and the design are subject to change without notice due to improvements in technology.

