

XTREME SPRAY AND POUR GUN



POLYURETHANE
MACHINERY CORPORATION

See Gun Manual for operation, maintenance, and a complete list of parts and kits.

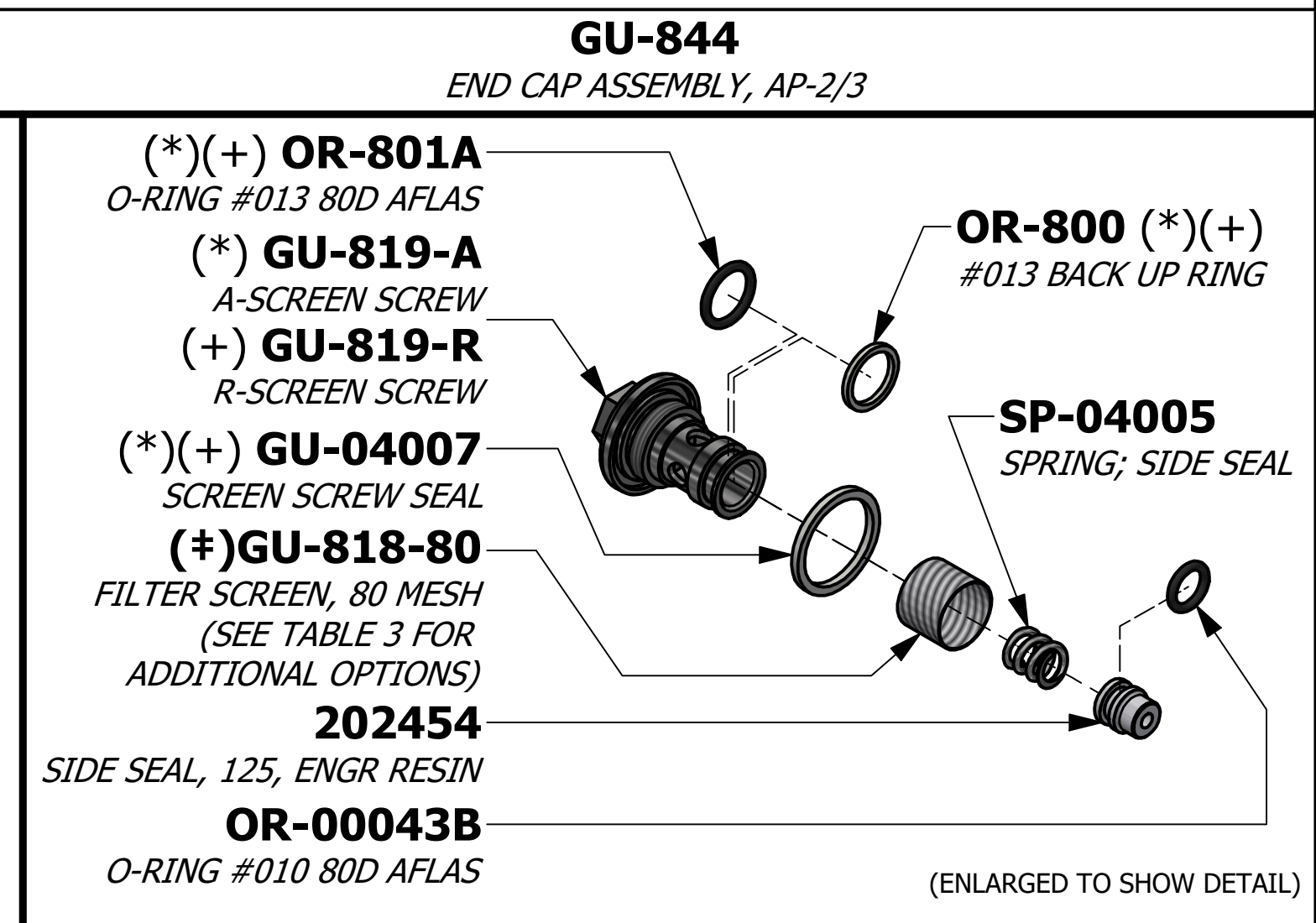
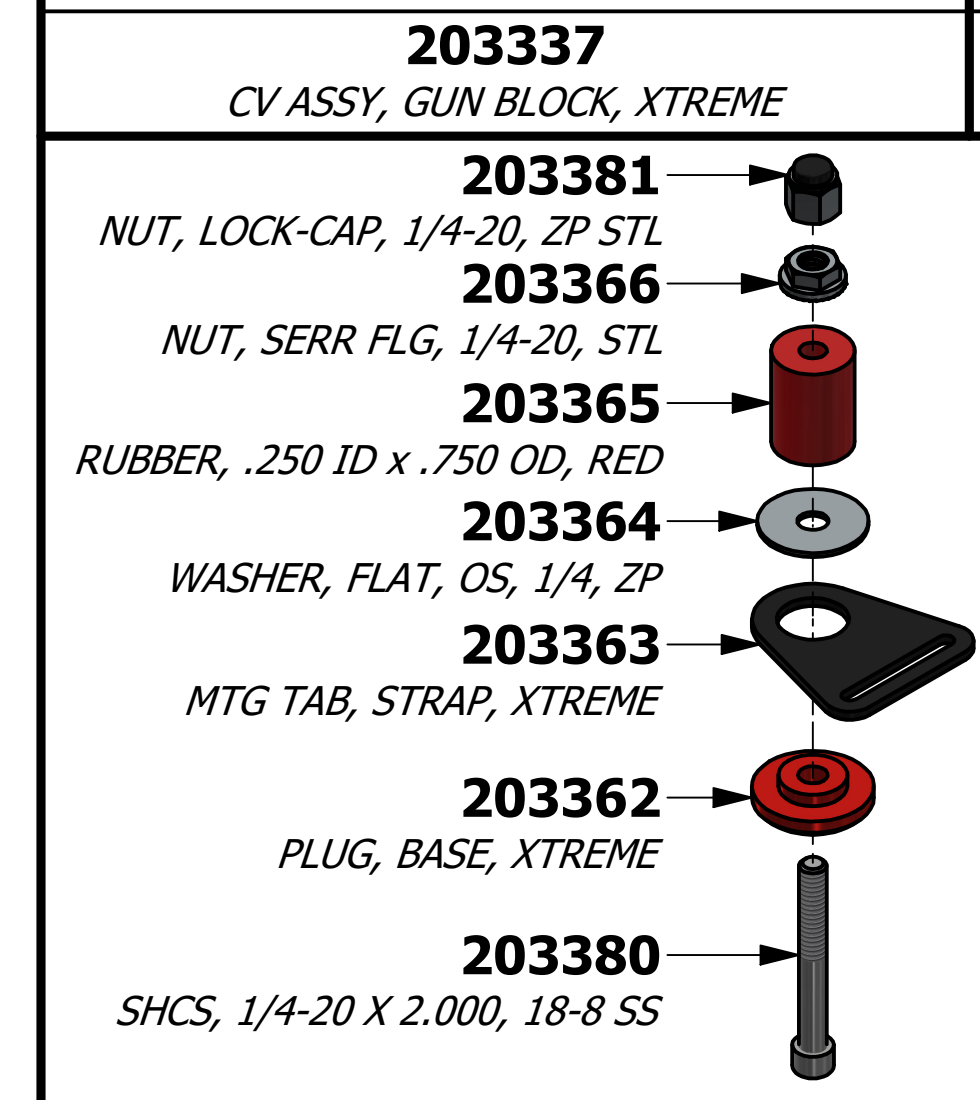
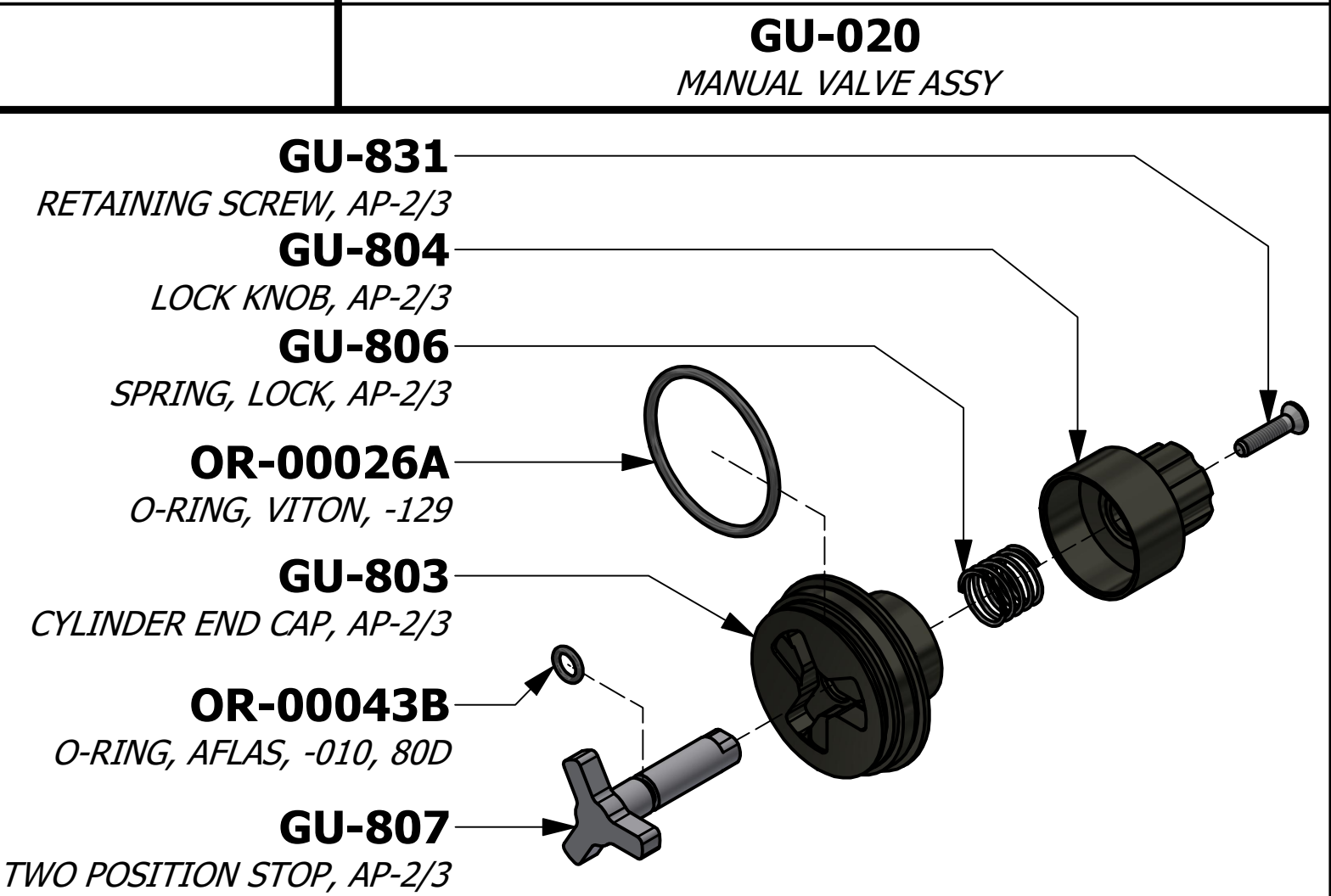
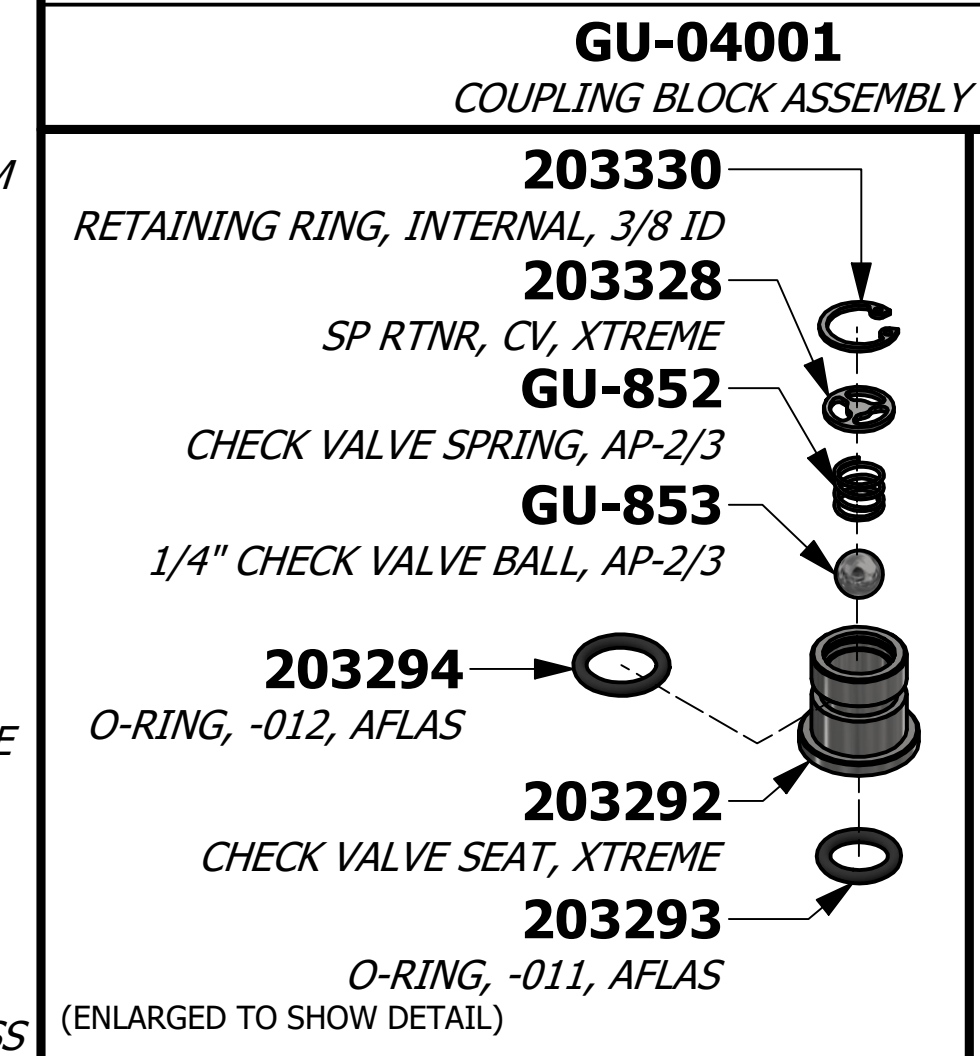
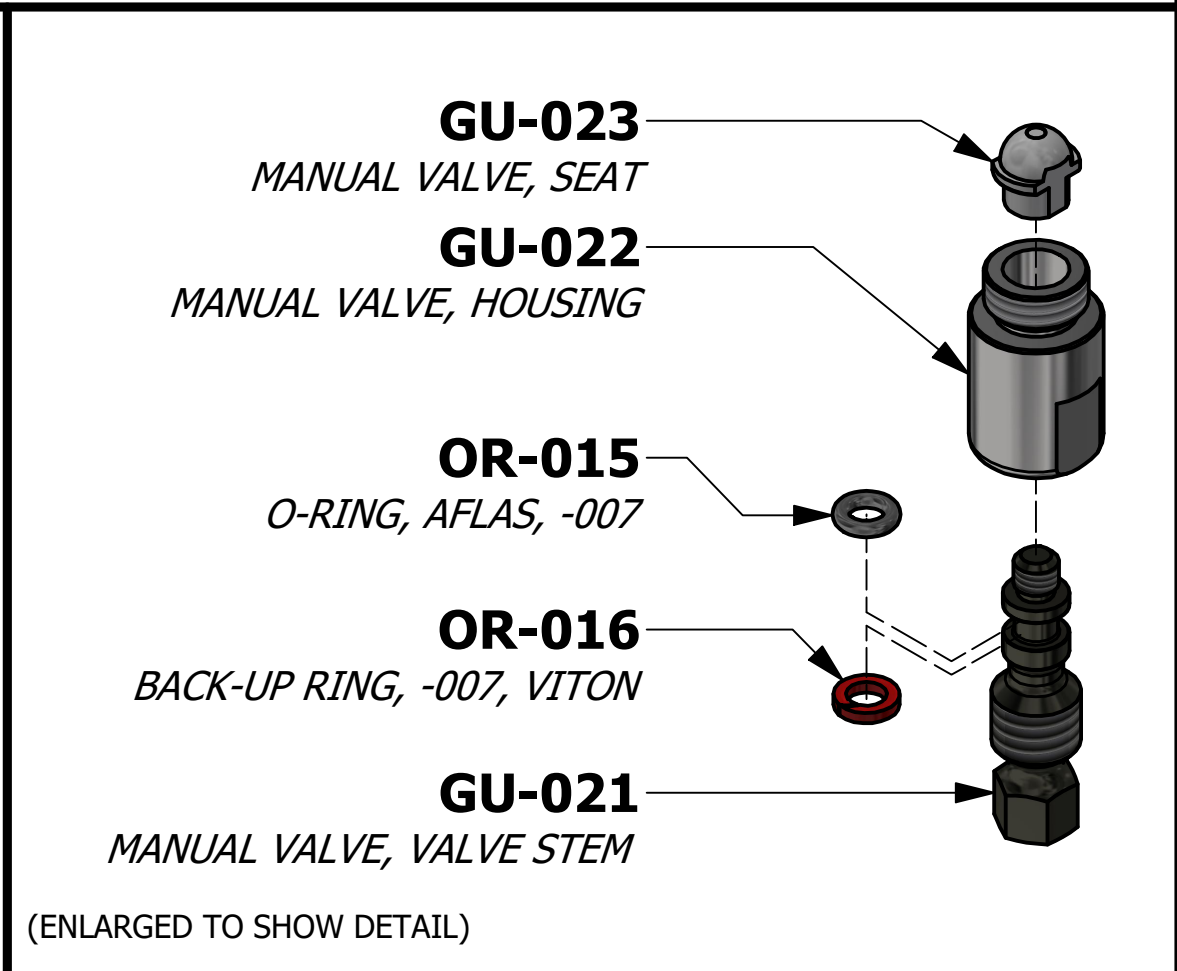
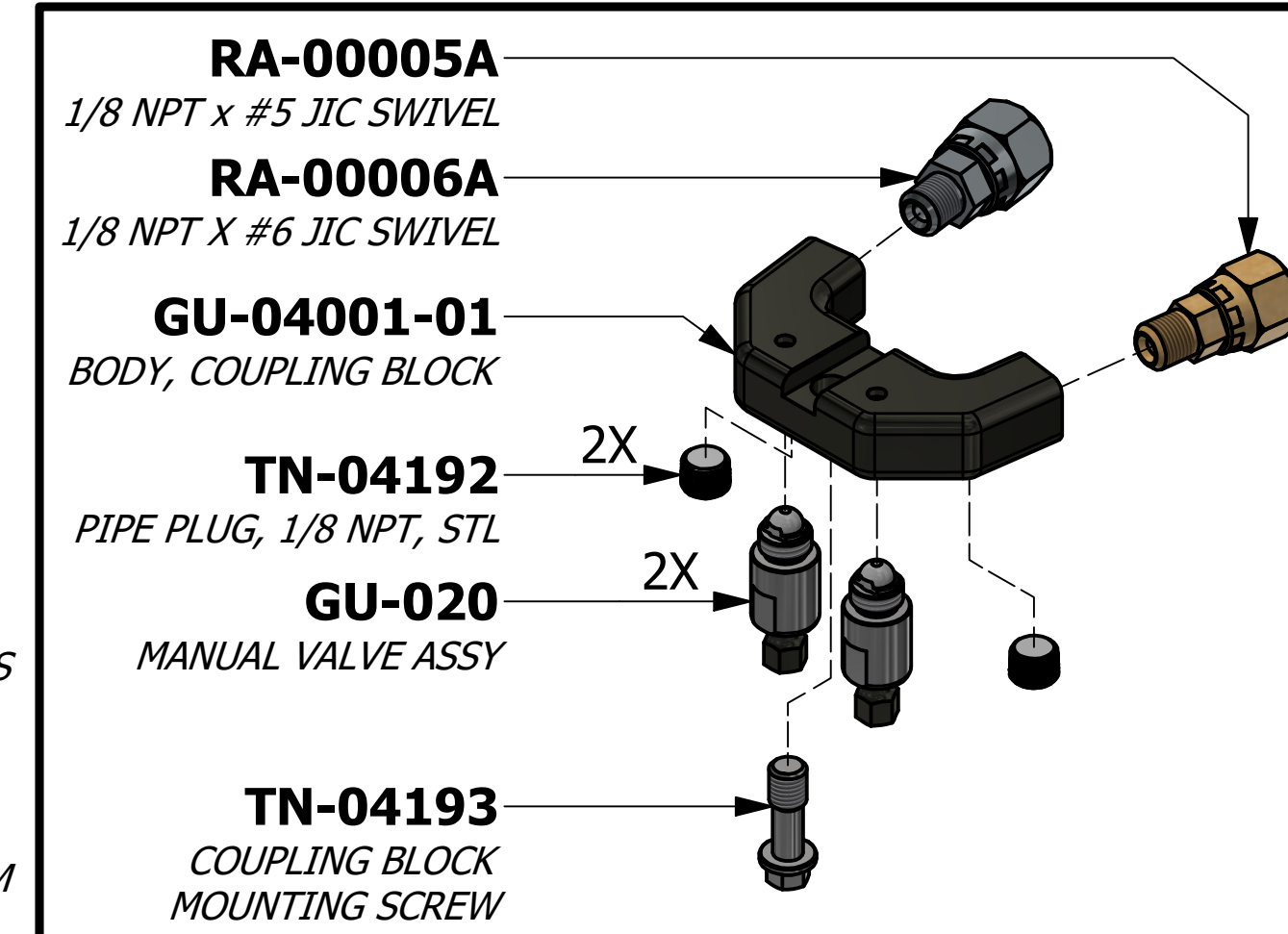
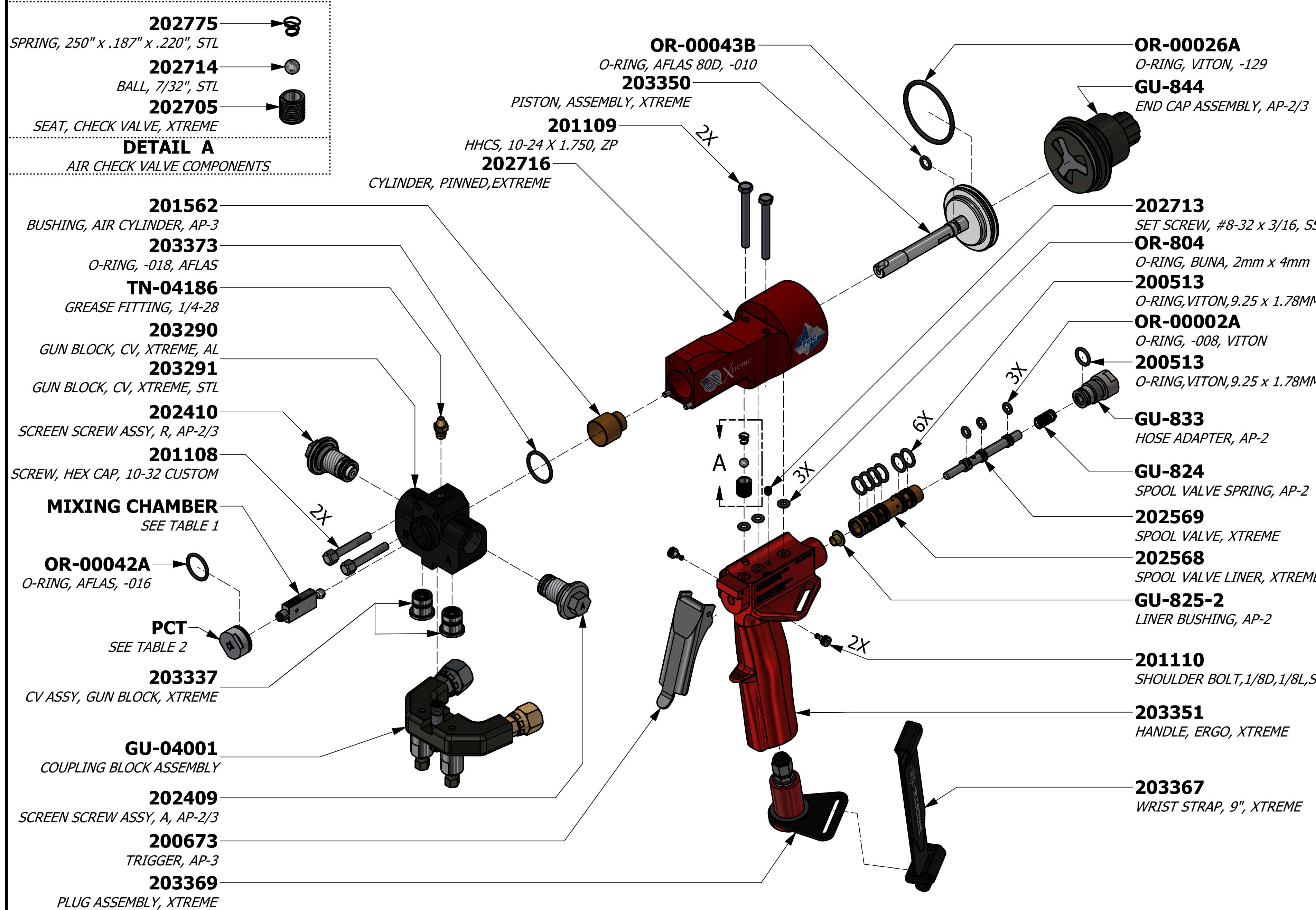

TABLE 1: MIXING CHAMBER KITS

PART NUMBER	DESCRIPTION
GU-814-DP-000	CHAMBER, 000 W/ DRILLS, DP
GU-814-DP-00	CHAMBER, 00 W/ DRILLS, DP
GU-814-DP-00X	CHAMBER, 00X W/ DRILLS, DP
GU-814-DP-01	CHAMBER, 01 W/ DRILLS, DP
GU-814-DP-01X	CHAMBER, 01X W/ DRILLS, DP
GU-814-DP-02	CHAMBER, 02 W/ DRILLS, DP
GU-814-DP-02X	CHAMBER, 02X W/ DRILLS, DP
GU-814-DP-03	CHAMBER, 03 W/ DRILLS, DP
GU-814-DP-04	CHAMBER, 04 W/ DRILLS, DP
GU-814-DP-05	CHAMBER, 05 W/ DRILLS, DP

TABLE 2: PATTERN CONTROL TIP (PCT) KITS

PART NUMBER	DESCRIPTION
GU-815-000	PCT, 000 W/ DRILLS
GU-815-00	PCT, 00 W/ DRILLS
GU-815-00X	PCT, 00X W/ DRILLS
GU-815-01	PCT, 01 W/ DRILLS
GU-815-01X	PCT, 01X W/ DRILLS
GU-815-02	PCT, 02 W/ DRILLS
GU-815-02X	PCT, 02X W/ DRILLS
GU-815-03	PCT, 03 W/ DRILLS
GU-815-04	PCT, 04 W/ DRILLS
200919	PCT, 05 W/ DRILLS

TABLE 3: FILTER SCREEN OPTIONS

PART NUMBER	DESCRIPTION
GU-818-40	FILTER SCREEN, 40 MESH
GU-818-60	FILTER SCREEN, 60 MESH
GU-818-80 (#)	FILTER SCREEN, 80 MESH

(#): Factory Standard. Other options must be purchased separately.

202409 SCREEN SCREW ASSY, A, AP-2/3
202410 SCREEN SCREW ASSY, R, AP-2/3
 (*) Parts with an asterisk are included in the KT-819-A Kit.
 (+) Parts with a plus sign are included in the KT-819-R Kit.