

PL70e–BT Manual



Scan for more support
and livechat with us

Thank you for choosing PL70e–BT printer
Read thoroughly before use. Keep for further reference.

Warning

1. The print head can be very hot after printing. Do not touch the print head.
2. Do not allow the print head to be scratched or damaged in any way.
3. Do not use unprovided accessories.
4. Do not attempt any repairs on your own. Contact sales for assistance.
5. Keep away from direct sunlight, water, dust, and other debris.
6. Unplug when idle for a long time.
7. Keep away from children.

Appearance and Components

Front view

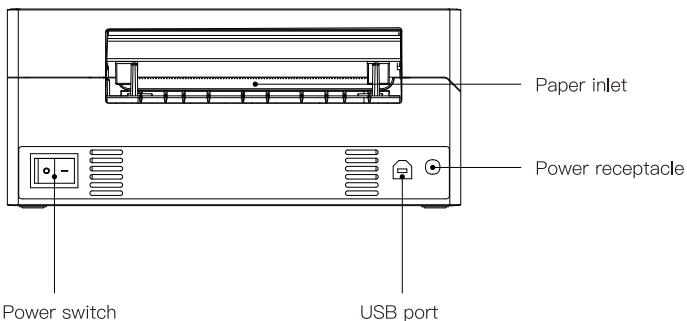
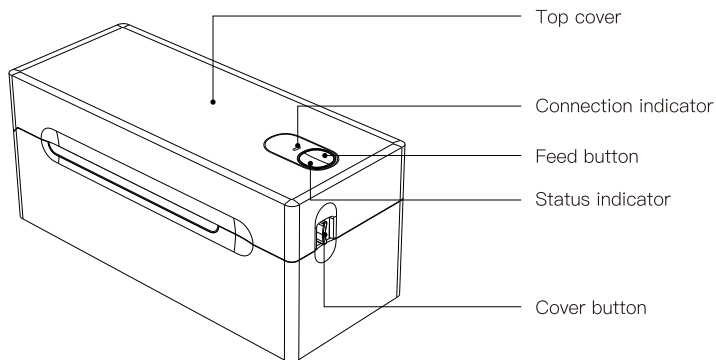

Inside view

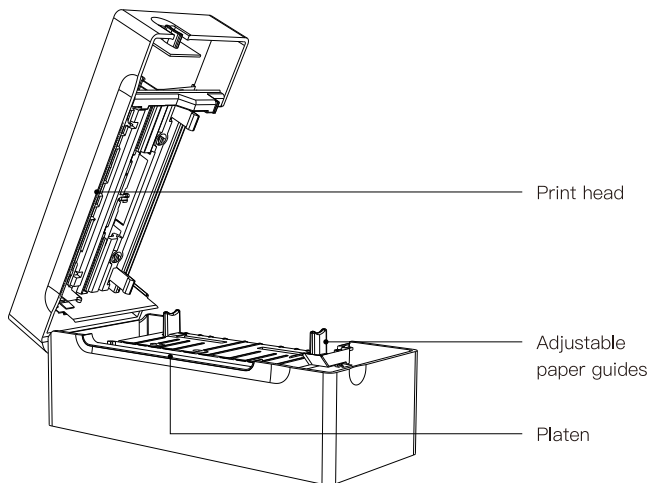

Packing list

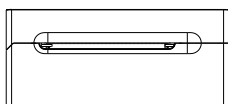

Printer

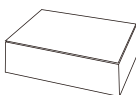

Test labels

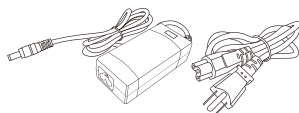

Power cable

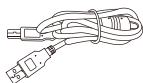

USB cable



USB-C to USB-A adapter
(for computer with only
USB-C port)



U-disk
(contains drivers
and user guide)

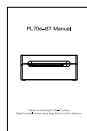

Manual

Notes:

The above diagrams are to be used for reference only; parts and components may vary depending on your order.

Print using Bluetooth function via phone

1. Search for “Shipping Printer Pro” on the App Store or Google Play and install the app.
2. Power on the printer.
3. Open “Shipping Printer Pro”, allow app access to “Bluetooth,” “Location,” and “Storage” permissions. Click on “Not connected” to add the printer.
4. After it is connected, click on “File,” select the file you want to print, click edit, then print.

Notes:

1. Bluetooth function only available for mobile phone and Windows, Not Mac. For Mac, you need to connect the printer via USB cable and install driver file.
2. For Mac with M1, M2 CPU, you can also search for “Shipping Printer Pro” on App Store and install, connect and print via Bluetooth through Shipping Printer Pro. Do not connect via Bluetooth directly.

Print using Bluetooth function on Windows

1. Before installation, power on the printer.
2. Browse the U-disk or turn to official website, go to “Support Driver & User Manual”, download the driver file and install.

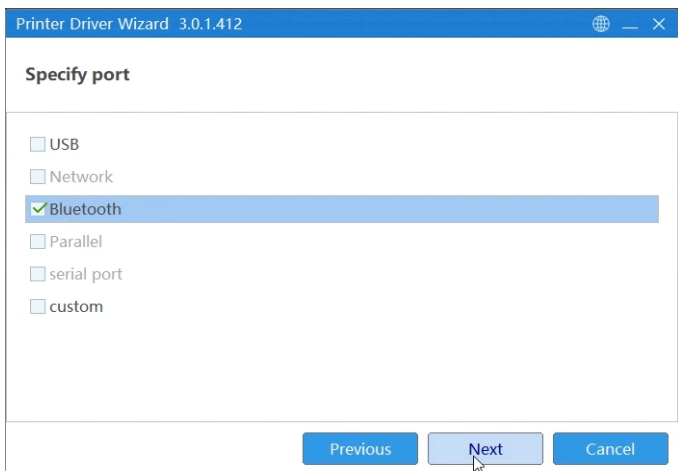

Select “Bluetooth”. Click on “Next”

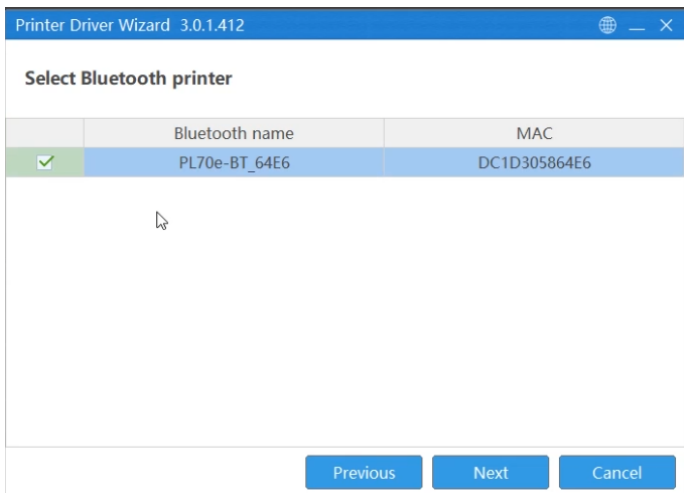

Select “PL70e–BT”, click on “Next”

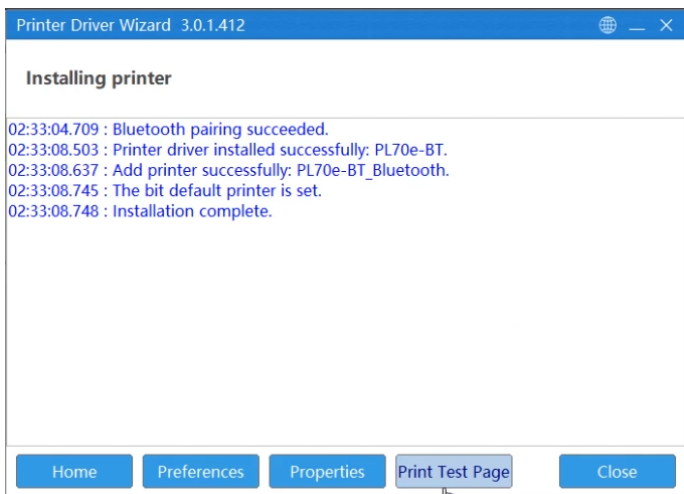

Wait for connection, which may takes 3–5 minutes, then click on “Print Test Page” to check if printer set up correctly.

Notes:

1. Do not connect the printer to Windows via Bluetooth on settings by yourself. Install the driver and select “Bluetooth” , the driver will connect the printer to computer automatically.
2. Normally, Bluetooth is available in 5 meters distance, make sure phone/ computer and printer as close as possible and less than 5 meters.
3. Print using Bluetooth function on Windows may takes minutes for printer to respond and print, for faster printing, set up printer on Windows via USB cable by installing the driver and select “USB”.

Windows Setup (USB)

Driver installation

1. Before installation, plug in and power on the printer. Connect it to your computer via the USB cable.
2. Download and install the Windows driver file from our website or the included U-disk.

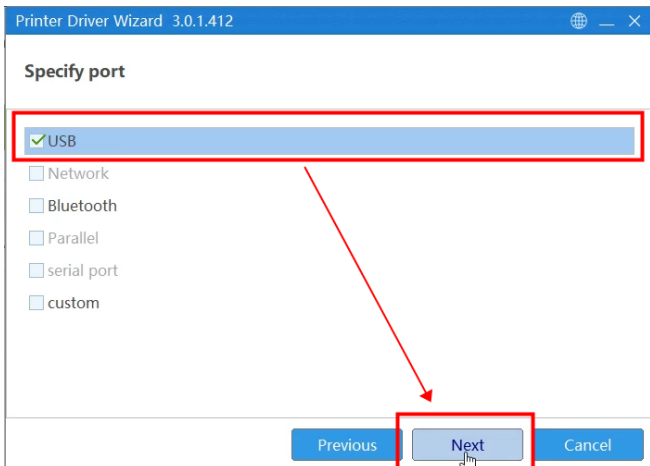

Select USB, click on “Next”

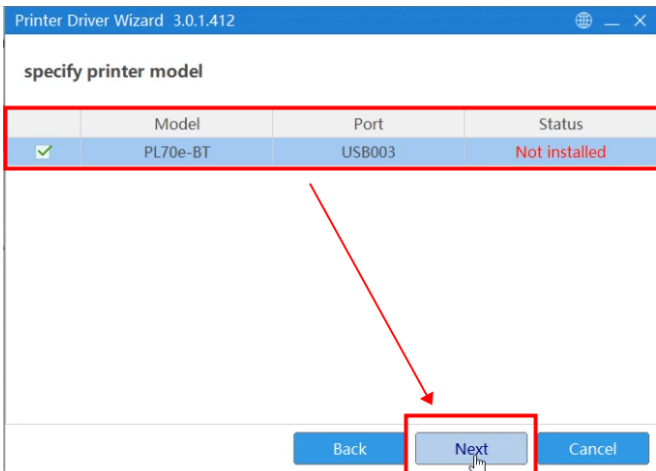

Select "PL70e-BT", click on "Next"

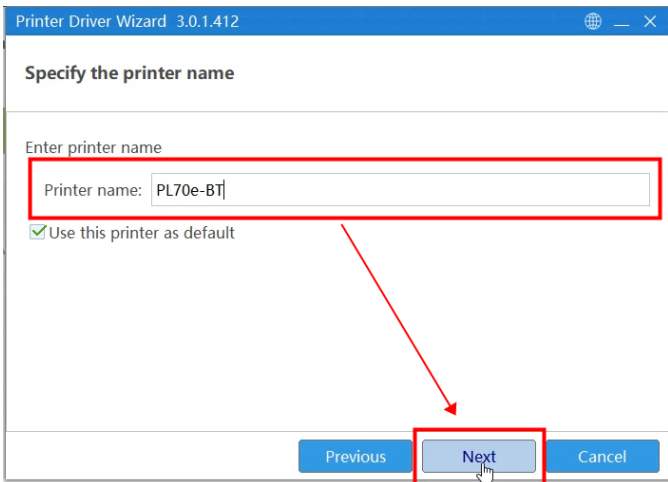

Input printer name, click on "Next"

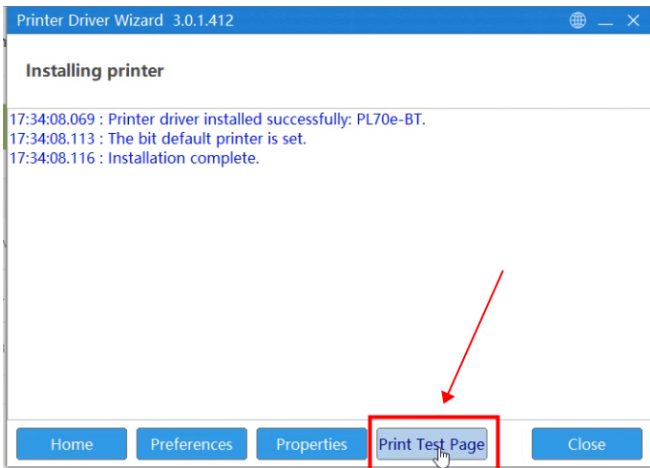

After installation complete, click on “Print Test Page” to check if printer set up successfully. Otherwise, reinstall.

Change Printer Settings

1. Go to “Settings” – ”Devices” – ”Printers & Scanners” – ”PL70e–BT” – ”Manage,” then click on “Print a test page” to check if the printer is set up correctly.
2. Click on “Printing preferences” to set the page size or adjust print darkness.

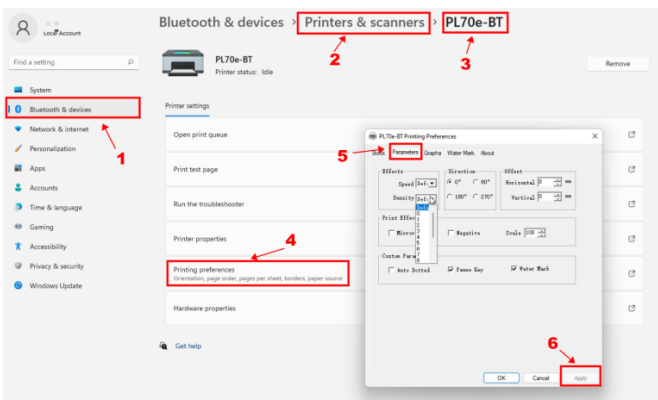

Mac Setup (USB)

Driver installation

1. Before installation, plug in and power on the printer. Connect it to your computer via the USB cable.

Notes:

1. For computers that don't have a USB-A port, use the included adapter instead of a hub or docking station, which may prevent the computer from detecting the printer.
2. If it shows "The application can't be opened", go to "System Settings" - "Privacy & Security", slide down and click on "Open Anyway"

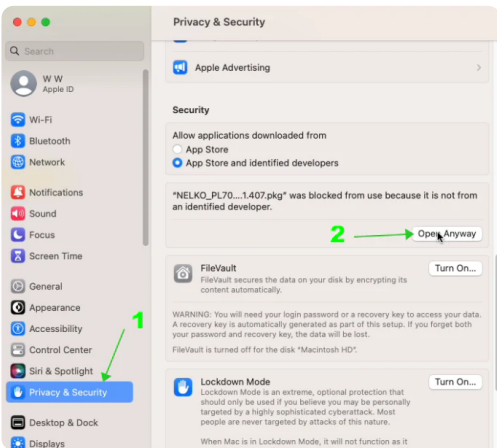
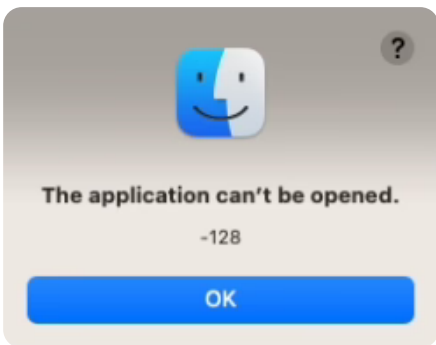
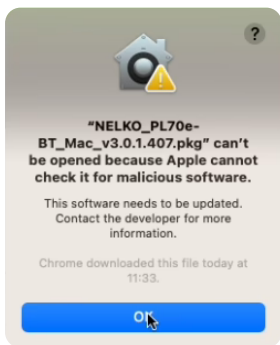

2. Download and install the Mac driver file from our website or the included U-disk.

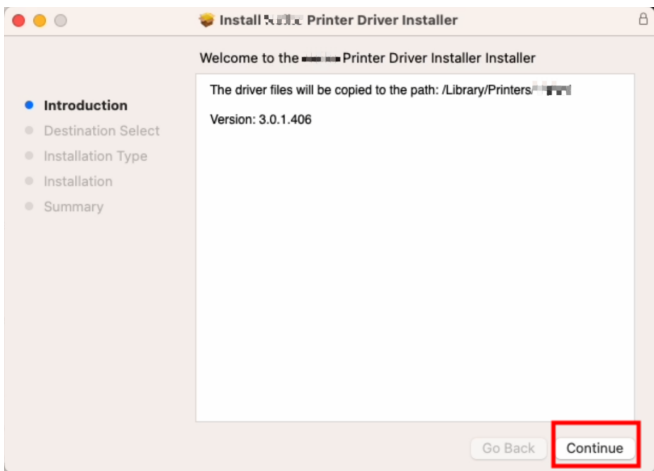

Open driver file, click on “Continue”

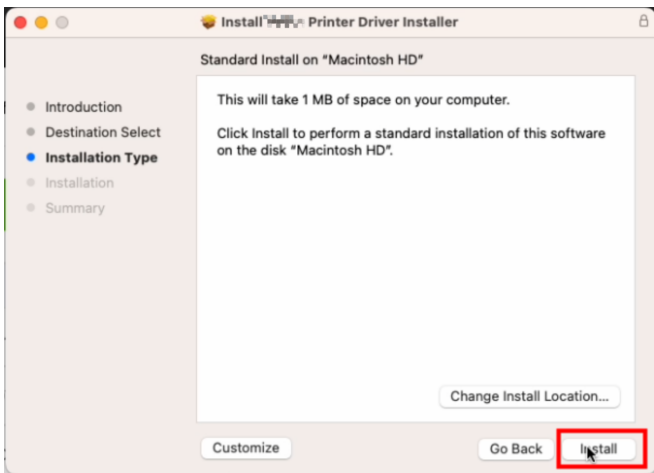

Click on “Install”

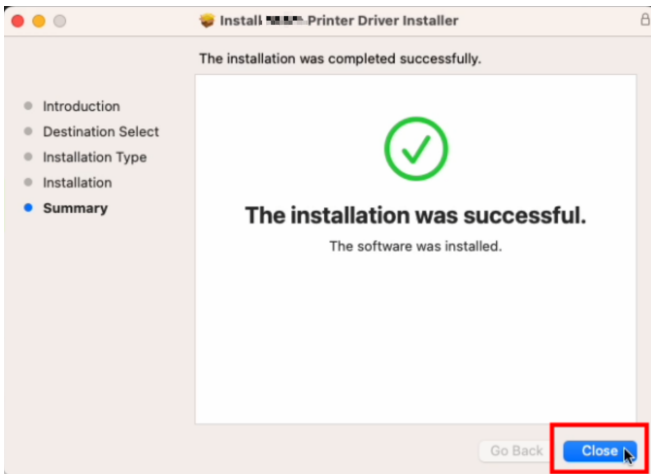

After installation successfully, click on “Close”

3. Go to “System Preferences” – ”Printers & Scanners”, click on “Add Printer, Scanner, or Fax...” to add a printer. Select “PL70e-BT”, select “PL70e-BT” at use, then click on “Add” to finish.

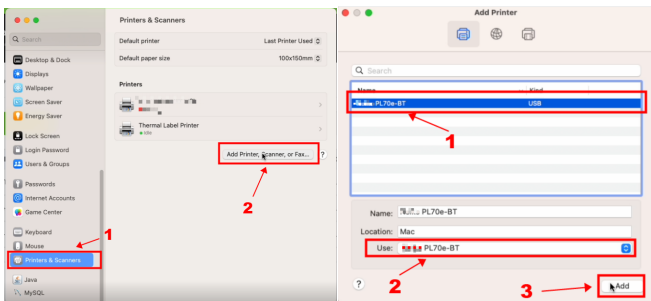

Change Page Size

1. Open any PDF file, click on “Show more”, then click on “Page size” to select or manage the page size.

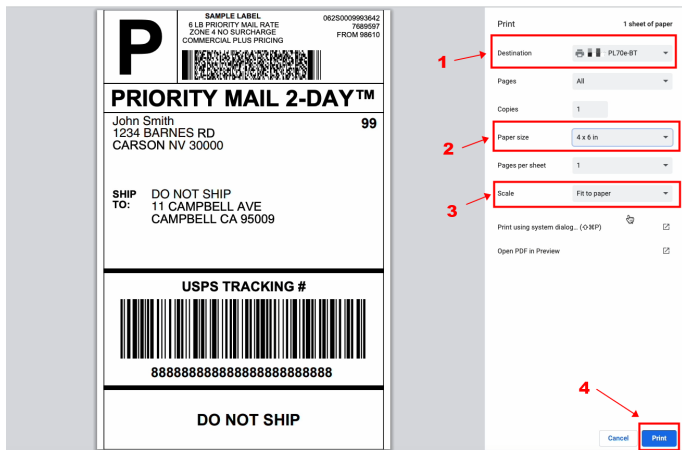

Loading the paper

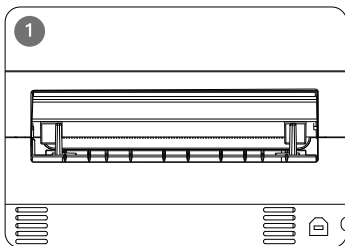

Power on the printer and adjust the paper guides to fit the width of paper.

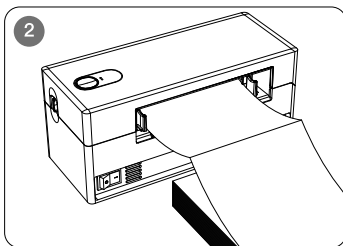

Insert the paper into the inlet.

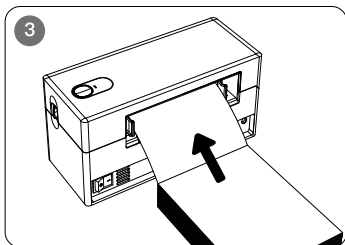

The paper will automatically feed into the printer.

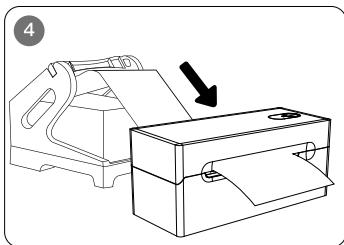

Using label holder

Notes:

1. When the printer is powered on, the paper will automatically feed through the path.
2. Not all orders will include a paper holder.

Clearing paper jams

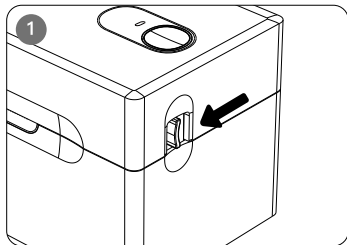

Slide the cover open lever to open the top cover.

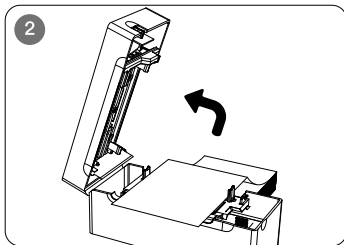

Remove the jammed paper, then clean up the print head and platen.

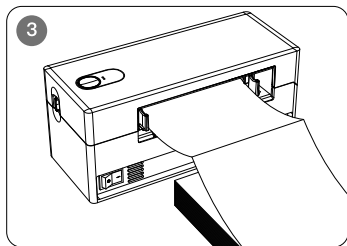

Reload new paper.

Notes: Power off the printer when clearing a paper jam.

Power connection

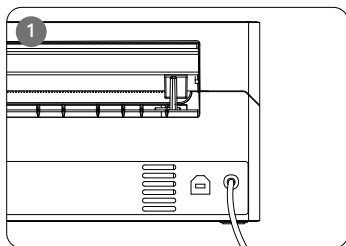

Connect the power cable to the power receptacle on the printer.

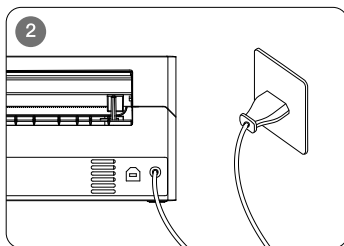

Connect the other end of the power cord to the socket.

Cleaning and maintenance

1. Power off the printer and unplug the power cable from both ends. Open the printer's top cover.
2. If the printer has just been used for printing, allow the print head to cool down for 2–3 minutes.
3. Clean the print head with alcohol using a dust-free cloth or while wearing rubber gloves.
4. Wait until the alcohol has just completely dried.
5. Plug in and power on the printer. Press and hold the feed button until it beeps twice to print a test page.

Specification

Printing method	Direct thermal
Resolution	203 dpi
Max print speed	150 mm/s (approximately 6 in. /s)
Print width	40–104mm/ 1.57–4.1 in.
Power input	24V $\overline{=}$ 2A
Work Environment	5~40°C,90%RH(no condensation)
Storage Environment	5~40°C,90%RH(no condensation)
Driver support	Windows, Mac

Indicator status

Connection indicator	Description
Blinks blue	Bluetooth not connected
No light	USB connected, but Bluetooth not connected
Steady blue	Bluetooth connected, waiting for print, or printing

Status indicator	Description
Blinks red	Cover open/ out of paper/ print head overheat
Steady green	Waiting for print or printing finished
Blinks green	Transferring data

FAQs

1. I installed the printer's driver. Why am I unable to print?

The printer needs to be powered on and connected to the computer prior to installing the driver. Uninstall the driver and then reinstall.

2. Why am I printing blank labels?

Make sure you are using thermal labels, and the labels are oriented correctly with the label facing upwards.

3. How do I set or change page size or print darkness?

Windows:

Go to Settings–Devices–Printers & Scanners–Label printer–Manage, click on “Printing preferences”. The Page size can be changed from here. Click on “Advanced” to adjust print darkness.

Mac:

Open any PDF file, click on “Show more”, then click on “Page size” to select or manage the page size.

FCC Statement

This device complies with part 15 of the FCC Rules. Operation is subject to the following two conditions: (1) This device may not cause harmful interference, and (2) this device must accept any interference received, including interference that may cause undesired operation.

NOTE 1: This equipment has been tested and found to comply with the limits for a Class B digital device, pursuant to part 15 of the FCC Rules. These limits are designed to provide reasonable protection against harmful interference in a residential installation. This equipment generates, uses and can radiate radio frequency energy and, if not installed and used in accordance with the instructions, may cause harmful interference to radio communications. However, there is no guarantee that interference will not occur in a particular installation. If this equipment does cause harmful interference to radio or television reception, which can be determined by turning the equipment off and on, the user is encouraged to try to correct the interference by one or more of the following measures:

- Reorient or relocate the receiving antenna.
- Increase the separation between the equipment and receiver.
- Connect the equipment into an outlet on a circuit different from that to which the receiver is connected.
- Consult the dealer or an experienced radio/TV technician for help.

NOTE 2: Any changes or modifications to this unit not expressly approved by the party responsible for compliance could void the user's authority to operate the equipment. This equipment complies with FCC radiation exposure limits set forth for an uncontrolled environment. This equipment should be installed and operated with minimum distance 20cm between the radiator & your body.

Warranty

We offer an extensive warranty for all products that extends through 1 YEAR of the order date. This warranty covers quality related issues and product defects.

If you are past the 30-day return period on Amazon, contact us directly via the "Contact seller" option on your Order Details.

If the product is not working properly, we can send you a replacement product.

This warranty does not apply in cases of abuse, mishandling, or unauthorized repair of the product.

If you have any question about this warranty or would like additional information, please contact us via the "Contact Seller" option or directly via e-mail (check the packing box). Please keep the original box, packing materials and all documentation in the event that service is required.