

Portable Label Maker

Read thoroughly before using



Thanks for choosing P21 printer

Warning

- The paper bin must be clean. Any debris will catch and damage the print head while printing.
- Use alcohol to clean the paper bin and print head.
- Do not disassemble the printer or attempt any self-repairs. Power off the printer if any malfunctions occur.
- Charge in a cool and ventilated room. Do not expose the printer to high humidity or temperatures.
- Keep away from water.
- If any strange scents or smoke comes from the printer, poweroff and unplug immediately.
- Avoid dropping or shaking the printer to prevent damage.
- Do not open the cover while it is printing.
- Do not touch the print head immediately after printing as it will be HOT.
- Use a soft clean cloth to clean the outside of the printer.
- High temperatures may result in poor print quality.
- Use label paper offered by printer manufacturer for best results. Use of other label printers may result in poor print quality or damage to the printer.
- The longevity of the printed labels depends on the quality of the label paper.
- Choose high quality label paper if you need them to last.
- Keep away from children.
- Store in a clean and dry environment.
Printer does NOT come with an adapter. Use one with a rating of 5V 1A.
- This printer can only be used in non-tropical environments.
- The printer may cause radio interference. Take any necessary precautionary measures.

Machine Parameters

Print Technology	Direct Thermal
Resolution	203 DPI
Print Speed	60 mm/s MAX
Supported Paper Width	15mm (12mm available)
Supported Paper type	Gap Paper/ Continuous Paper
Connection	Bluetooth
Paper Cutting	Manual Paper Cutting
Battery	1200 mAh
Charge	Type-C
Input	5V 1A DC
Work Environment	5~40°C,90%RH(no condensation)
Storage Environment	5~40°C,90%RH(no condensation)
Life expectancy	50 km
Product Size	79.5x30x130.6 mm

The contents of this manual may change without prior notice. The components, hardware, software, and technology may be upgraded for better functionality. Contact sales or customer support with any questions or concerns.

Figure

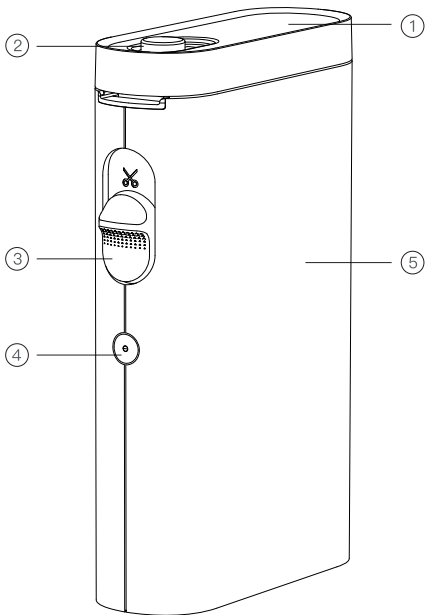

① Cover

② Cover Button

③ Cutting Button

④ Indicator

⑤ Body

APP Download

For Android and Apple users, you can search “Nelko” in Google Play or APP store and install.

The second method is scan the QR below code.



IOS



Android

Install Label Printer Paper

- 1.Slide the cover button to the other side to open the cover.
- 2.Load the paper roll in the paper bin. Refer to the image for the correct placement.
- 3.Unroll the paper enough so that it sticks out of the printer slightly.
- 4.Close the cover. Press the power/ feed button to calibrate the label and test the printer.

Notes: Use label paper offered by printer manufacturer for best result.

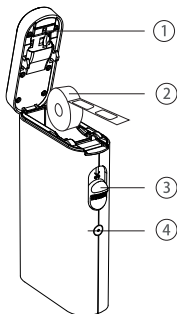

- ① Print Head
- ② Label Paper Roll
- ③ Cutting Button
- ④ Power/ Feed Button

Connect Machine

1. Turn on Bluetooth on your phone
2. Long press the power button to start the machine
3. Open the “Nelko” App, Tap “UnConnected”
4. Find “P21”, tap “Click to connect”

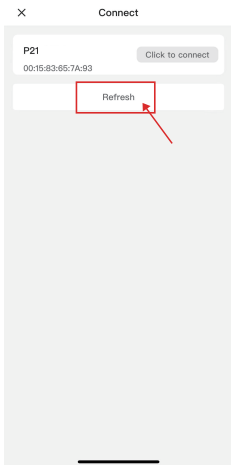
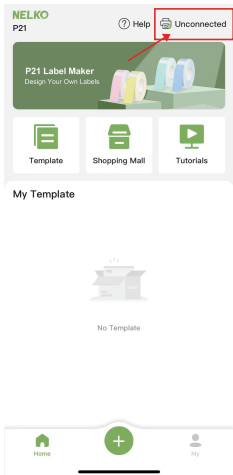

Create New Label

1. Tap “+” to edit label

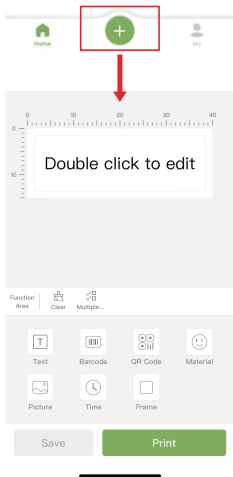

2. Click the ⚙️ key to customize the label size and paper type

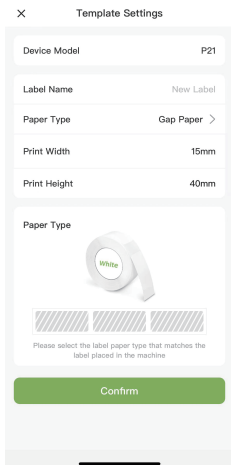

3. Tap “Text” to input text

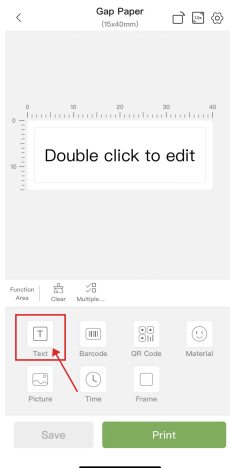

4. Edit function description After adding, tap to “Print”

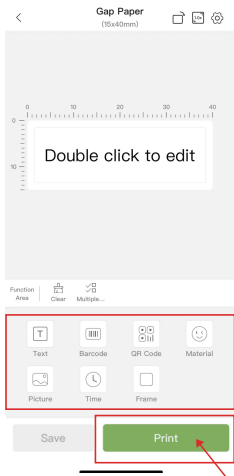

5. Select the copies and print

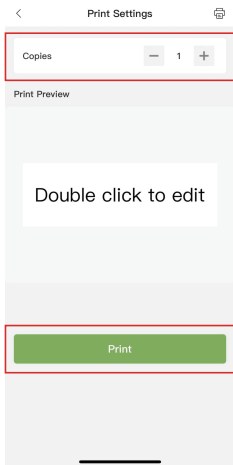

How to choose a label to print it

1. Click "Template"

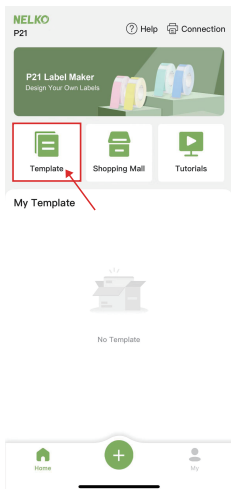

2. Select a template based on your needs

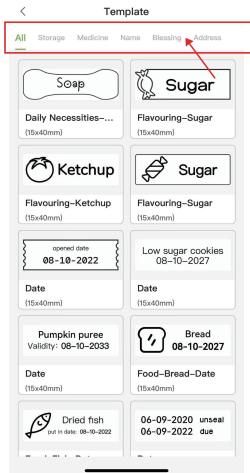

3. Click the template to edit

4. Click "Print"

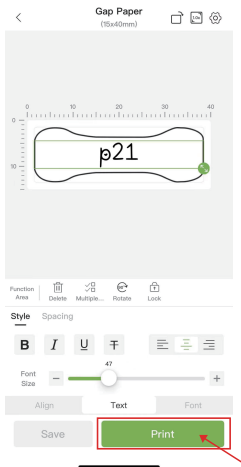

NELKO

Contact us:

E-mail: support@nelko.net

www.nelkoprint.com



Scan to User Instruction

Quick Guide

1. Search for and install app on Google Play or App Store.
2. Long press (hold) the power button to turn on the machine.
3. Slide cover button to the other side and open the cover, place a roll of thermal paper into the bin.
4. Press the power button to run one label.
5. Use the app to connect the printer to the phone via Bluetooth. Allow app access “Bluetooth” and “Location” permission to search and connect printer.
6. Use the app to create and edit labels. Then print.
7. Push the cutting button upwards to cut the label.

Indicator Light

Indicator	Status
Flash Green	Charging
Steady Green	Fully charged
Flash Red	Print head overheat or low battery, printing can't be finished
Steady Red	Cover is open or out of paper, printing can't be finished

Troubleshooting

Q: Why are the labels not aligned properly?

A: Change the paper type on the app. Realign the printer by pressing the Power/ Feed button once.

Q: Why are the labels not printing clearly?

A: Check and adjust the printing density. If there is a line or blank area on the label, check if the print head is clean. If not, clean it with alcohol. Low quality paper may also introduce problems. For best results, use label paper offered by printer manufacturer.

FCC Statement

This device complies with Part 15 of the FCC Rules.

Operation is subject to the following two conditions:

(1) this device may not cause harmful interference, and (2) this device must accept any interference received, including interference that may cause undesired operation.

This equipment has been tested and found to comply with the limits for a Class B digital device, pursuant to part 15 of the FCC Rules.

These limits are designed to provide reasonable protection against harmful interference in a residential installation.

This equipment generates uses and can radiate radio frequency energy and, if not installed and used in accordance with the instructions, may cause harmful interference to radio communications.

However, there is no guarantee that interference will not occur in a particular installation. If this equipment does cause 17 harmful interference to radio or television reception, which can be determined by turning the equipment off and on, the user is encouraged to try to correct the interference by one or more of the following measures:

- Reorient or relocate the receiving antenna.
- Increase the separation between the equipment and receiver.
- Connect the equipment into an outlet on a circuit different from that to which the receiver is connected.
- Consult the dealer or an experienced radio/TV technician for help.

The device has been evaluated to meet general RF exposure requirement.

The device can be used in portable exposure condition without restriction.

IC Caution

English:

This device complies with Industry Canada licence–exempt RSS standard(s).

Operation is subject to the following two conditions:

- (1) This device may not cause interference, and
- (2) This device must accept any interference, including interference that may cause undesired operation of the device.

To maintain compliance with RSS–102 RF Exposure guidelines, This equipment should be installed and operated with minimum 20cm distance between the radiator and your body:

Use only the supplied antenna.

French:

Le présent appareil est conforme aux CNR d'Industrie Canada applicables aux appareils radio exempts de licence.

L'exploitation est autorisée aux deux conditions suivantes:

- (1) l'appareil ne doit pas produire de brouillage, et
- (2) l'utilisateur de l'appareil doit accepter tout brouillage radioélectrique subi, même si le brouillage est susceptible d'en compromettre le fonctionnement.

Pour être conforme aux lignes directrices d'exposition RF RSS–102, cet équipement doit être installé et exploité à une distance minimale de 20cm entre le radiateur et votre corps: n'utilisez que l'antenne fournie.

Warranty

We offers an extensive warranty for all products that extends through 1 YEAR of the order date. This warranty covers quality related issues and product defects.

If you are past the 30–day return period on Amazon, contact us directly via the “Contact seller” option on your Order Details.

If the product is not working properly, we can send you a replacement product. This warranty does not apply in cases of abuse, mishandling, or unauthorized repair of the product.

If you have any question about this warranty or would like additional information, please contact us via the “Contact Seller” option or directly via e–mail (check the packing box). Please keep the original box, packing materials and all documentation in the event that service is required.