

Kailh

KAIHUA ELECTRONICS

Document Number:

KH-PS2104-22

Product Specification

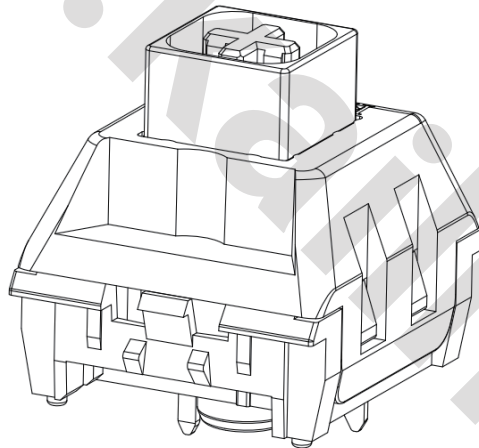

P/N:

CPG1511F01S63

Title :

PG1511F Keyboard Switch

Content

| | |
|---|-----|
| 1. Scope | 3 |
| 2. Product Application | 3 |
| 3. Technology Parameters | 3 |
| 4. Ratings | 3 |
| 5. Profile Dimensions | 3 |
| 6. Electrical Performance | 4 |
| 7. Mechanical Performance | 5~6 |
| 8. Environmental Performance | 7~9 |
| 9. Recommended PCB Layout | 10 |
| 10. Loading Parameter Specification | 11 |
| 11. Precaution | 11 |

| | | | |
|------------------------------|----------------------------------|-------------------|----------------------|
| P/N: CPG1511F01S63 | DOC. No.: KH-PS2104-22 | Rev.: A | Page: 3/11 |
|------------------------------|----------------------------------|-------------------|----------------------|

1. Scope:

This Product Specification covers the requirement of Mechanical Keyboard switch on product performance, test methods and quality assurance provisions.

2. Product Application:

Mainly applied on computer keyboards, cash registers, industrial equipment and Man-Machine interface.

3. Technology Parameters:

Ambient Humidity: 45 ~ 85% RH

Operating Temperature Range: $-10^{\circ}\text{C} \sim +70^{\circ}\text{C}$

Storage Temperature Range: $-20^{\circ}\text{C} \sim +70^{\circ}\text{C}$

Suggested storage period: about 6 months

Require the tin part on the switch terminals should keep good after storage guarantee date

Normal Condition:

Ambient temperature: $20 \pm 2^{\circ}\text{C}$

Relative humidity: $65\% \pm 5\% \text{RH}$

Air pressure: 86~101KPa

Solder Ability: Lead-tin soldering: 245°C Max 5s Max

Lead free soldering: 255°C Max 5s Max

Withstand Soldering Temperature: Wave soldering: $260 \pm 5^{\circ}\text{C}$ $5 \pm 0.5\text{s}$

4. Ratings

Rating: 12V AC/DC max. 2V DC min

10mA AC/DC max. $10\mu\text{A}$ DC min

Insulation Resistance: $\geq 100\text{M}\Omega/\text{DC}$ 100V

Withstand Voltage: 100 AC 1 Minute

Mechanical Life: 80,000,000 Cycles

5. Profile Dimensions

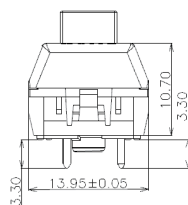
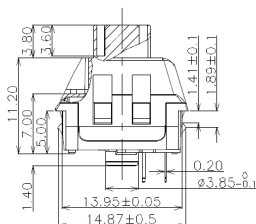
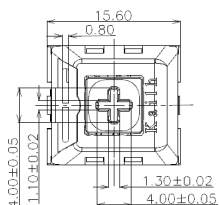

6. Electrical Performance

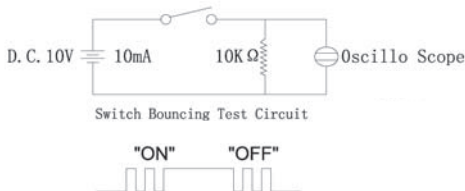
| Item | Description | Test Condition | Requirement |
|------|---------------------------------|---|--|
| 6.1 | Contact Resistance | <p>Static load: (Operation force)x2, which is applied on the center of Switch stem. Be measured when the switch contact stabilization.</p> <p>Measurement tool: Contact resistance Meter. (1KHz,20mV,5~50mA)</p> <p>Measured at low current (100mA or less).</p> | 200mΩ Max |
| 6.2 | Insulation Resistance | <p>Apply a Voltage of DC 100 V for 1 minute, according to the below method.</p> <p>(1) Between terminals. (2) Between terminal and Body.</p> | 100mΩ Min |
| 6.3 | Dielectric withstanding voltage | <p>Apply a Voltage of AC100 V (50~60Hz) for 1 minute, according to the below method.</p> <p>(1) Between terminals. (2) Between terminal and Body.</p> | No evidence of breakdown |
| 6.4 | Bouncing | <p>Operation speed: 3~4 times/s</p> <p>Oscillo scope</p> <p>Switch Bouncing Test Circuit</p>  <p style="text-align: center;">Switch Bouncing Test Circuit</p> <p style="text-align: center;">"ON" "OFF"</p> | <p>Before Life cycle: On: 5ms MAX Off: 5ms MAX</p> <p>After Life cycle: On: 10ms MAX Off: 10ms MAX</p> |

7. Mechanical Performance

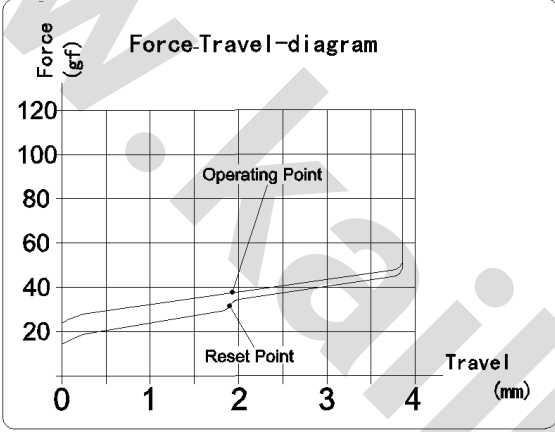
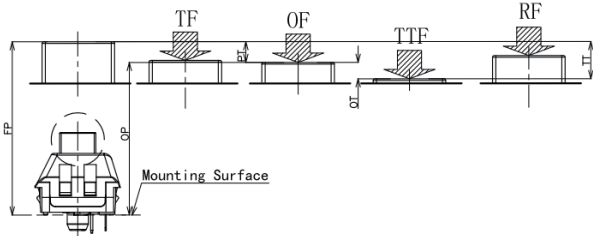
| Item | Description | Test Condition | Requirement |
|------|-------------------|---|-------------|
| 7.1 | Load Curve | <p>Place the vertical direction of switch operation and gradually increase the load applied to the center of the stem until it stop.</p>  <p>The diagram is a line graph titled "Force-Travel diagram". The vertical axis is labeled "Force (gf)" and ranges from 0 to 120 in increments of 20. The horizontal axis is labeled "Travel (mm)" and ranges from 0 to 4 in increments of 1. Two curves are shown: an upper curve representing the "Operating Point" and a lower curve representing the "Reset Point". Both curves start at approximately 20 gf at 0 mm travel and rise to about 40 gf at 2 mm travel. The "Operating Point" curve continues to rise to approximately 50 gf at 4 mm travel, while the "Reset Point" curve drops back to about 30 gf at 4 mm travel.</p> | See page 11 |
| 7.2 | Loading parameter | <p>Place the vertical direction of switch operation and gradually increase the load applied to the center of the stem until it stop.</p>  <p>The diagram shows a cross-sectional view of a switch mechanism. It includes labels for various loading points: TF (Top Force), OF (Operating Force), TTF (Total Top Force), and RF (Reset Force). A "Mounting Surface" is also indicated at the bottom of the mechanism. Dimensions E, G, and H are shown with arrows indicating their respective measurements on the switch assembly.</p> | See page 11 |

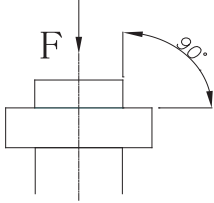
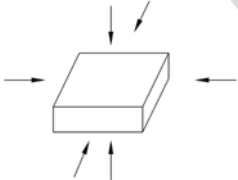
| | | | |
|-----|--------------------|---|--|
| 7.3 | Static Strength | <p>A static load of 3kgf shall be applied in the direction of button operation for a period of 60 seconds.</p>  | <p>No damage (Electrical) And mechanical</p> |
| 7.4 | Stem Pull Strength | <p>Break by a pull force applied opposite to the direction of stem operation.</p> | <p>5kgf Min</p> |
| 7.5 | Shock | <p>Measured by according to the below condition: (1) Acceleration: 80g (2) Cycles of test: 3 cycles each in 6 directions, for a total of 18 cycles.</p>  | <p>Shall meet No.6, 7.1, 7.2.</p> |
| 7.6 | Life Test | <ol style="list-style-type: none"> 1) D.C.12V 10mA resistance load 2) Operation speed: 5-6 times / s 3) Push force: 150gf 4) Operation number: 80,000,000cycles | <p>Contact resistance: 1Ω Max Bouncing: 10ms Max Operation force and tactile force: Variation rate within ±30%</p> |

8. Environmental Performance

| Item | Description | Test Condition | Requirement | | | | | | | | | | | | |
|---------|----------------------------|---|---|-------------|------------------|---------|---------------------------|----|----------------------------|----|---------------------------|----|---------------------------|----|---|
| 8.1 | Cold test | (1) Temperature: $-20\pm 2^{\circ}\text{C}$ (2) Duration of test: 48h (3) Take off a drop water (4) Standard conditions after test: 1h | Contact resistance: 200m Ω Max Shall meet: No. 6.2 to 6.4 No. 7.1 to 7.2 | | | | | | | | | | | | |
| 8.2 | Heat test | (1) Temperature: $70\pm 2^{\circ}\text{C}$ (2) Duration of test: 48h (3) Take off a drop water (4) Standard conditions after test: 1h | Contact resistance: 200m Ω Max Shall meet: No. 6.2 to 6.4 No. 7.1 to 7.2 | | | | | | | | | | | | |
| 8.3 | Temperature cycle | (1) Test cycles: 5 cycles (2) Standard condition after test: 1h <table border="1"> <thead> <tr> <th></th> <th>Temperature</th> <th>Duration of test</th> </tr> </thead> <tbody> <tr> <td rowspan="4">1 cycle</td> <td>$20\pm 5^{\circ}\text{C}$</td> <td>1h</td> </tr> <tr> <td>$-20\pm 5^{\circ}\text{C}$</td> <td>1h</td> </tr> <tr> <td>$20\pm 5^{\circ}\text{C}$</td> <td>1h</td> </tr> <tr> <td>$70\pm 5^{\circ}\text{C}$</td> <td>1h</td> </tr> </tbody> </table> | | Temperature | Duration of test | 1 cycle | $20\pm 5^{\circ}\text{C}$ | 1h | $-20\pm 5^{\circ}\text{C}$ | 1h | $20\pm 5^{\circ}\text{C}$ | 1h | $70\pm 5^{\circ}\text{C}$ | 1h | Contact resistance: 200m Ω Max Shall meet: No. 6.2 to 6.4 No. 7.1 to 7.2 |
| | Temperature | Duration of test | | | | | | | | | | | | | |
| 1 cycle | $20\pm 5^{\circ}\text{C}$ | 1h | | | | | | | | | | | | | |
| | $-20\pm 5^{\circ}\text{C}$ | 1h | | | | | | | | | | | | | |
| | $20\pm 5^{\circ}\text{C}$ | 1h | | | | | | | | | | | | | |
| | $70\pm 5^{\circ}\text{C}$ | 1h | | | | | | | | | | | | | |

8.4

Soldering heat test

Soldering area: T/2 of PWB thickness.
(PWB: T=1.6mm)
Soldering temperature: $260\pm 5^{\circ}\text{C}$
Soldering time: $5\pm 0.5\text{s}$

Wave Soldering Temperature Curve (Single Wave Peak)

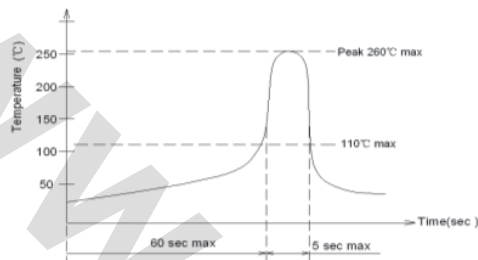

Appearance:
No abnormality.

8.5

Solder ability

Lead-tin soldering
Soldering temperature: $245\pm 5^{\circ}\text{C}$
Soldering time: $5\pm 0.5\text{s}$

Lead free soldering
Soldering temperature: $255\pm 5^{\circ}\text{C}$
Soldering time: $5\pm 0.5\text{s}$

At least 90% of surface area of immersed portion shall be covered by solder.

| | | | |
|-----|---|--|--|
| 8.6 | Humidity test | (1) Temperature: $60\pm 2^{\circ}\text{C}$ (2) relative humidity: 90~95% R.H. (3) Duration of test: 48h (4) Take off a drop water (5) Standard conditions after test: 1h | Contact resistance: 200m Ω Max Shall meet : No. 6.2 to 6.4 No. 7.1 to 7.2 |
| 8.7 | Salt Spray | Apply the following environment to test(Only for contact test) : (1) Temperature: $35\pm 5^{\circ}\text{C}$ (2) Salt water density: $5\pm 1\%$ (3) Duration: 12hours (4) After test, the salt deposit shall be removed by running water. | Appearance: No corrosion spot, no crack, no base plate naked. Contact Resistance: 200 m Ω Max |
| 8.8 | Protection Against ingress of dust(IP5X) | The switches are placed in a position of normal use inside the test chamber. The test is carried out according to the second enclosure of IEC60529/GB4208. The test shall be continued for a period of 8h. | After test: Operating is normal Between terminals, terminal and surface of the crust, Dielectric withstand in voltage $\geq 100\text{V}$ |
| 8.9 | Protection against ingress of water(IPX4) | The switches are placed in a position of normal use inside the test table. The test is carried out according to the second enclosure of IEC60529/GB4208. | After test: Operating is normal. Water don't enter electric parts of the switch inside. Between terminals, terminal and surface of the crust, Dielectric withstand in voltage $\geq 100\text{V}$ |

9. Recommended PCB Layout

Mounting Options

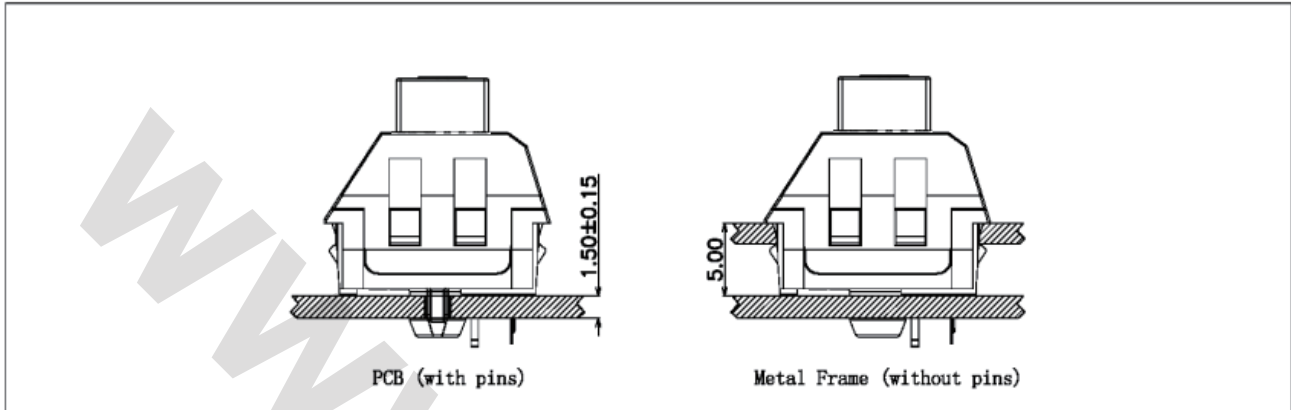

Circuit Board Layouts

Grid line spacing = 1.27mm

Keyswitch without fixation pins

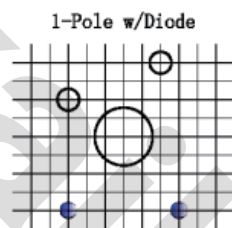
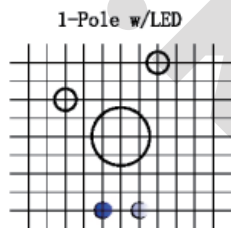
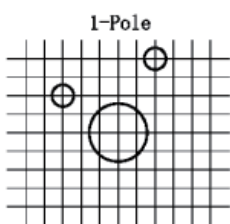

$\varnothing 3.99 \pm 0.1$



$\varnothing 1.50 \pm 0.05$



$\varnothing 1.0 \pm 0.1$

Keyswitch with fixation pins

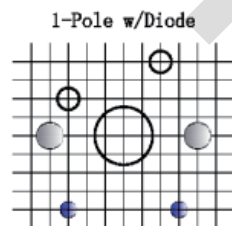
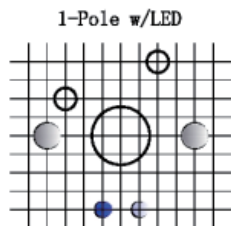
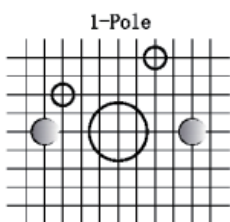

$\varnothing 3.99 \pm 0.1$



$\varnothing 1.70 \pm 0.05$



$\varnothing 1.50 \pm 0.05$



$\varnothing 1.0 \pm 0.1$

Metal Frame Cutout Dimensions

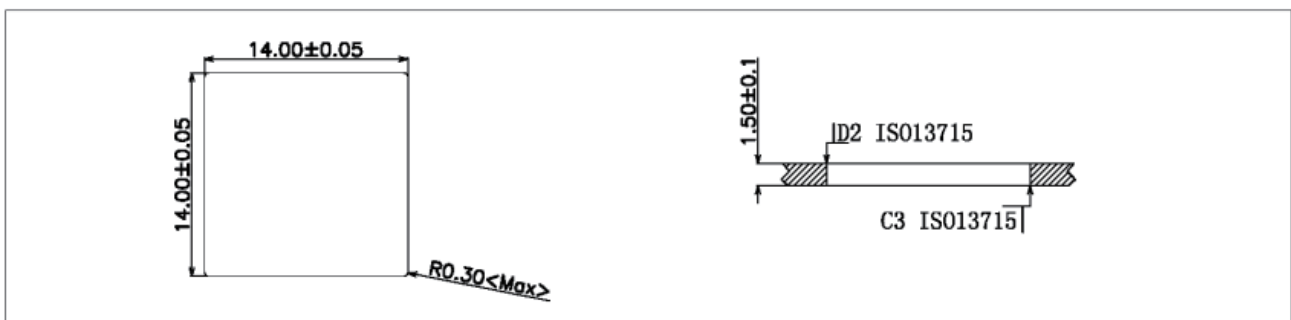

10. Loading Parameter (TT/PT/OT /OF/TF/RF) Specification

| Parameter | Unit | Specification | Remark |
|-----------|------|---------------|--------|
| TT | mm | 3.60±0.3 | |
| PT | mm | 1.80±0.4 | |
| OT | mm | 1.30 | |
| OF | gf | 40±10 | |

11. Precaution

11.1 Immersion Soldering condition

| ITEM | CONDITION |
|-----------------------|---|
| Preheat temperature | 110°C Max (Ambient temperature of soldering surface of P.W.B) |
| Preheat time | 60s, Max |
| Area of flux | 1/2 Max of PWB Thickness |
| Temperature of solder | 260±5°C |
| Time of immersion | 3±0.5s |
| Number of soldering | 2time Max (But should down heat of the first soldering) |
| Printed wiring board | Single side copper-clad laminates |

- (1) After switches were soldered, please be careful not to clean switches with solvent
- (2) Under the condition of using soldering iron, soldering temperature shall be 350°C ± 5 °C with 3±0.5s

11.2 Notes

- (1) Please be cautious not to give excessive static load or shock to switches.
- (2) Please be careful not to stack up P. W. B. after switches were soldered.
- (3) Preservation under high temperature and high humidity or corrosive gas should be avoided Especially.
When you need to preserve for a long period, do not open the carton.
- (4) The standard storage period is 3 months, with maximum up to 6months, preferably to be used as soon as possible.
After opening the package, you should put the remaining switches in a plastic bag to prevent from damp and corrosive gas.
- (5) This Product Specification is considered as the technical agreement on product between the receiving customer and Kailh. Any information on Product Catalogue which is in conflict with or different from the corresponding information of this document is considered as invalid.
- (6) If customer issue purchase orders without confirmation by signature of this specification after receipt, such confirmation will be considered as granted upon receipt of the first purchase order.
- (7) If there is no order or no request for new specification after 1 year upon this specification is issued, the specification will be regarded as invalid.
- (8) Products meet the ROHS & REACH environmental management substances control standards.