

ABIDE BY ROHS

Pale Purple shaft

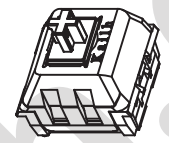

- Specification :
- 1. Rating : 12V AC/DC max. 2V DC min. 10mA AC/DC max. 10µA DC min.
 - 2. Contact Resistance : 200mΩ Max
 - 3. Insulation Resistance : 100MΩ Min (DC500V)
 - 4. Withstand Voltage : AC100V(50-60Hz) for 1 minute
 - 5. Bounce Time : ≤5msec (at 16 in/sec. actuation speed)
 - 6. Operation Force : 45±10gf
 - 7. Tactile Force : 60±10gf
 - 8. Conduction travel : 1.90mm±0.6mm
 - 9. Total travel : 3.8±0.6mm
 - 10. Operating Life : 70,000,000 Cycles(min).
<Feel is allowed to have difference before and after life test>

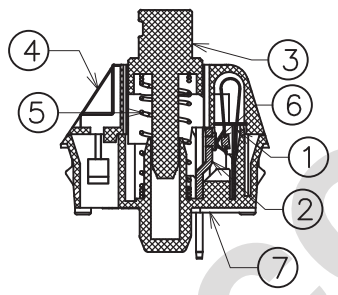
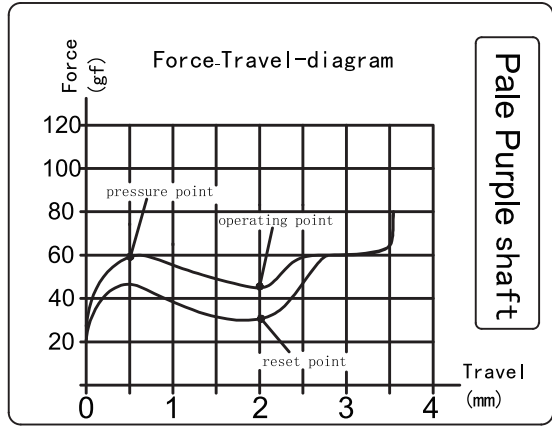
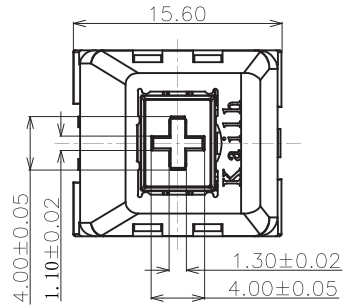
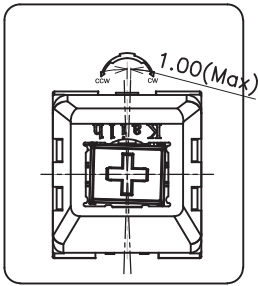
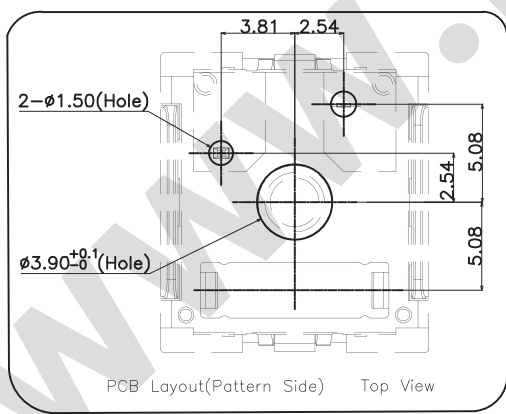
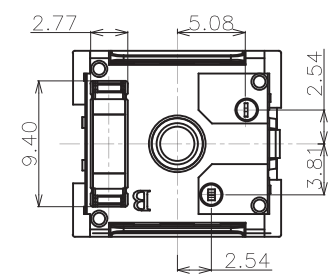
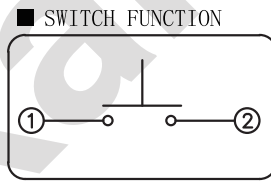
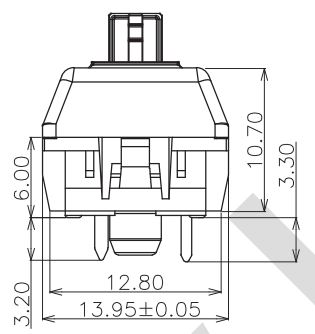
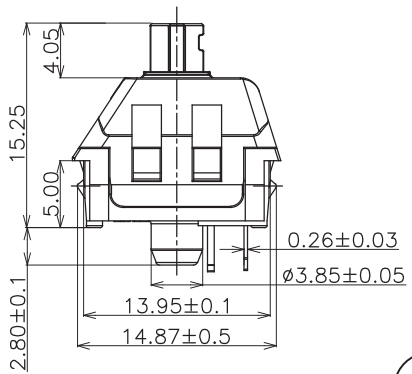

⑦	Base	1	PA66	Pale Purple		
⑥	contact	2	Composite gold			
⑤	Spring	1	Stainless Steel			
④	Cover	1	PC	Clear		
③	Keystroke	1	POM	Pale Purple		
②	static plate	1	Brass	Sn over Ni-plating		
①	movable plate	1	Copper Alloy			
ITEM	PART NAME	TER'NO	QTY.	MATERIAL	FINISHING	REMARK

APPROVALS		DATE		Kailh KAIHUA ELECTRONICS CO., LTD DRAWN HuHaixin 2020.07.24 CHECKED TITLE: PG1511 Keystroke Switch(Pale Purple shaft) APPROVALS PART NO. CPG151101D280		
TOLERANCES ARE		ANGLE				
30<L	±0.30	±2'	±2'	DRAWING NO. KHA-PG1511-284EN	SHEET 1 OF 1	
10<L30	±0.20					
5<L10	±0.15					
L≤5	±0.10					

ECN NO.	REV.	DATE.	DESCRIPTION.	CHANGE.	CHECK.	APPRO.
	A		NEW			

Kailh

KAIHUA ELECTRONICS

Document Number:

KH-PS2008-05

Product Specification

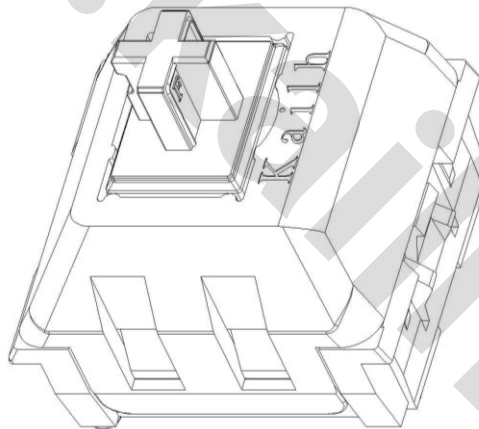

P/N:

CPG151101D280

Title :

PG1511 Keyboard Switch

P/N: CPG151101D280	DOC. No.: KH-PS2008-05	Rev.: A	Page: 2/11
------------------------------	----------------------------------	-------------------	----------------------

Content

1. Scope	3
2. Product Application	3
3. Technology Parameters	3
4. Ratings	3
5. Profile Dimensions	3
6. Electrical Performance	4
7. Mechanical Performance	5~6
8. Environmental Performance	7~9
9. Recommended PCB Layout	10
10. Loading Parameter Specification	11
11. Precaution	11

P/N: CPG151101D280	DOC. No.: KH-PS2008-05	Rev.: A	Page: 3/11
------------------------------	----------------------------------	-------------------	----------------------

1. Scope:

This Product Specification covers the requirement of Mechanical Keyboard switch on product performance, test methods and quality assurance provisions.

2. Product Application:

Mainly applied on computer keyboards, cash registers, industrial equipment and Man-Machine interface.

3. Technology Parameters:

Ambient Humidity: 45 ~ 85% RH

Operating Temperature Range: -10°C ~ +70°C

Storage Temperature Range: -20°C ~ +70°C

Suggested storage period: about 6 months

Require the tin part on the switch terminals should keep good after storage guarantee date

Normal Condition:

Ambient temperature: 20±2°C

Relative humidity: 65%±5%RH

Air pressure: 86~101KPa

Solder Ability: Lead-tin soldering: 245°C Max 5s Max

Lead free soldering: 255°C Max 5s Max

Withstand Soldering Temperature: Wave soldering: 260±5°C 5±0.5s

4. Ratings

Rating: 12V AC/DC max. 2V DC min

10mA AC/DC max. 10µA DC min

Insulation Resistance: ≥100MΩ/DC 100V

Withstand Voltage: 100 AC 1 Minute

Mechanical Life: 80,000,000 Cycles

5. Profile Dimensions

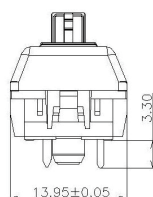
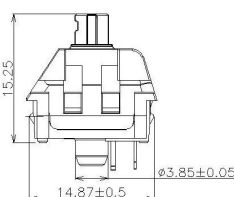
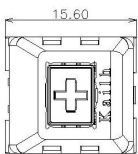

6. Electrical Performance

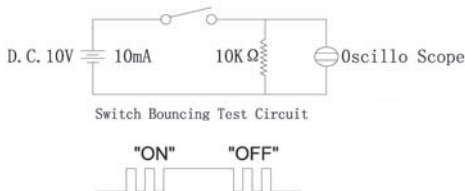
Item	Description	Test Condition	Requirement
6.1	Contact Resistance	<p>Static load: (Operation force)x2, which is applied on the center of Switch stem. Be measured when the switch contact stabilization.</p> <p>Measurement tool: Contact resistance Meter. (1KHz,20mV,5~50mA)</p> <p>Measured at low current (100mA or less).</p>	200mΩ Max
6.2	Insulation Resistance	<p>Apply a Voltage of DC 100 V for 1 minute, according to the below method.</p> <p>(1) Between terminals. (2) Between terminal and Body.</p>	100mΩ Min
6.3	Dielectric withstanding voltage	<p>Apply a Voltage of AC100 V (50~60Hz) for 1 minute, according to the below method.</p> <p>(1) Between terminals. (2) Between terminal and Body.</p>	No evidence of breakdown
6.4	Bouncing	<p>Operation speed: 3~4 times/s</p> <p>Oscillo scope</p> <p>Switch Bouncing Test Circuit</p>  <p style="text-align: center;">Switch Bouncing Test Circuit</p> <p style="text-align: center;">"ON" "OFF"</p>	<p>Before Life cycle: On: 5ms MAX Off: 5ms MAX</p> <p>After Life cycle: On: 10ms MAX Off: 10ms MAX</p>

7. Mechanical Performance

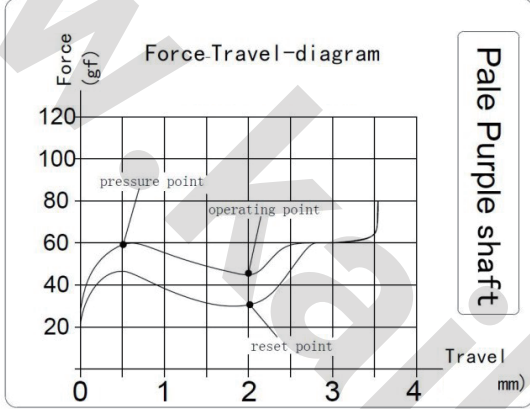
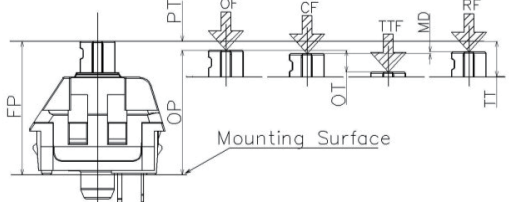
Item	Description	Test Condition	Requirement
7.1	Load Curve	<p>Place the vertical direction of switch operation and gradually increase the load applied to the center of the stem until it stop.</p> 	See page 11
7.2	Loading parameter	<p>Place the vertical direction of switch operation and gradually increase the load applied to the center of the stem until it stop.</p> 	See page 11

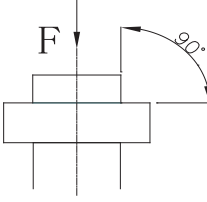
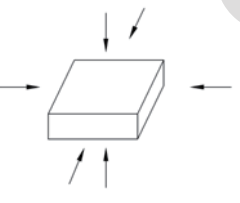
7.3	Static Strength	<p>A static load of 3kgf shall be applied in the direction of button operation for a period of 60 seconds.</p> 	<p>No damage (Electrical) And mechanical</p>
7.4	Stem Pull Strength	<p>Break by a pull force applied opposite to the direction of stem operation.</p>	<p>5kgf Min</p>
7.5	Shock	<p>Measured by according to the below condition: (1) Acceleration: 80g (2) Cycles of test: 3 cycles each in 6 directions, for a total of 18 cycles.</p> 	<p>Shall meet No.6, 7.1, 7.2.</p>
7.6	Life Test	<ol style="list-style-type: none"> 1) D.C.12V 10mA resistance load 2) Operation speed: 5-6 times / s 3) Push force: 150gf 4) Operation number: 80,000,000cycles 	<p>Contact resistance: 1Ω Max Bouncing: 10ms Max Operation force and tactile force: Variation rate within ±30%</p>

8. Environmental Performance

Item	Description	Test Condition	Requirement												
8.1	Cold test	(1) Temperature: $-20\pm 2^{\circ}\text{C}$ (2) Duration of test: 48h (3) Take off a drop water (4) Standard conditions after test: 1h	Contact resistance: 200m Ω Max Shall meet: No. 6.2 to 6.4 No. 7.1 to 7.2												
8.2	Heat test	(1) Temperature: $70\pm 2^{\circ}\text{C}$ (2) Duration of test: 48h (3) Take off a drop water (4) Standard conditions after test: 1h	Contact resistance: 200m Ω Max Shall meet: No. 6.2 to 6.4 No. 7.1 to 7.2												
8.3	Temperature cycle	(1) Test cycles: 5 cycles (2) Standard condition after test: 1h <table border="1"> <thead> <tr> <th></th> <th>Temperature</th> <th>Duration of test</th> </tr> </thead> <tbody> <tr> <td rowspan="4">1 cycle</td> <td>$20\pm 5^{\circ}\text{C}$</td> <td>1h</td> </tr> <tr> <td>$-20\pm 5^{\circ}\text{C}$</td> <td>1h</td> </tr> <tr> <td>$20\pm 5^{\circ}\text{C}$</td> <td>1h</td> </tr> <tr> <td>$70\pm 5^{\circ}\text{C}$</td> <td>1h</td> </tr> </tbody> </table>		Temperature	Duration of test	1 cycle	$20\pm 5^{\circ}\text{C}$	1h	$-20\pm 5^{\circ}\text{C}$	1h	$20\pm 5^{\circ}\text{C}$	1h	$70\pm 5^{\circ}\text{C}$	1h	Contact resistance: 200m Ω Max Shall meet: No. 6.2 to 6.4 No. 7.1 to 7.2
	Temperature	Duration of test													
1 cycle	$20\pm 5^{\circ}\text{C}$	1h													
	$-20\pm 5^{\circ}\text{C}$	1h													
	$20\pm 5^{\circ}\text{C}$	1h													
	$70\pm 5^{\circ}\text{C}$	1h													

8.4

Soldering heat test

Soldering area: T/2 of PWB thickness.
(PWB: T=1.6mm)
Soldering temperature: $260\pm 5^{\circ}\text{C}$
Soldering time: $5\pm 0.5\text{s}$

Wave Soldering Temperature Curve (Single Wave Peak)

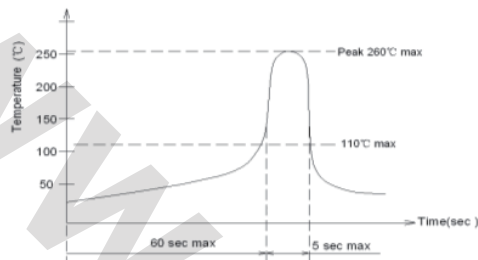

Appearance:
No abnormality.

8.5

Solder ability

Lead-tin soldering
Soldering temperature: $245\pm 5^{\circ}\text{C}$
Soldering time: $5\pm 0.5\text{s}$

Lead free soldering
Soldering temperature: $255\pm 5^{\circ}\text{C}$
Soldering time: $5\pm 0.5\text{s}$

At least 90% of surface area of immersed portion shall be covered by solder.

8.6	Humidity test	(1) Temperature: $60\pm 2^{\circ}\text{C}$ (2) relative humidity: 90~95% R.H. (3) Duration of test: 48h (4) Take off a drop water (5) Standard conditions after test: 1h	Contact resistance: 200m Ω Max Shall meet : No. 6.2 to 6.4 No. 7.1 to 7.2
8.7	Salt Spray	Apply the following environment to test(Only for contact test) : (1) Temperature: $35\pm 5^{\circ}\text{C}$ (2) Salt water density: $5\pm 1\%$ (3) Duration: 12hours (4) After test, the salt deposit shall be removed by running water.	Appearance: No corrosion spot, no crack, no base plate naked. Contact Resistance: 200 m Ω Max
8.8	Protection Against ingress of dust(IP5X)	The switches are placed in a position of normal use inside the test chamber. The test is carried out according to the second enclosure of IEC60529/GB4208. The test shall be continued for a period of 8h.	After test: Operating is normal Between terminals, terminal and surface of the crust, Dielectric withstand in voltage $\geq 100\text{V}$
8.9	Protection against ingress of water(IPX4)	The switches are placed in a position of normal use inside the test table. The test is carried out according to the second enclosure of IEC60529/GB4208.	After test: Operating is normal. Water don't enter electric parts of the switch inside. Between terminals, terminal and surface of the crust, Dielectric withstand in voltage $\geq 100\text{V}$

9. Recommended PCB Layout

Mounting Options

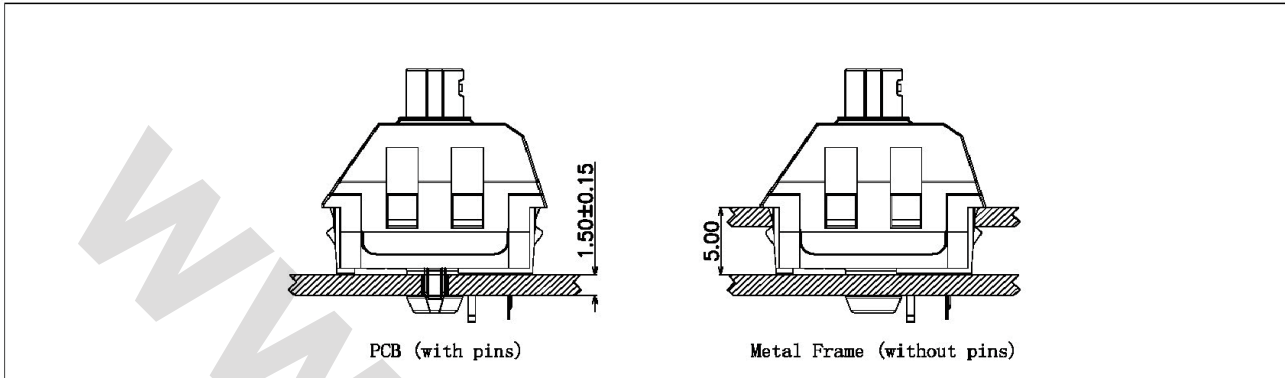

Circuit Board Layouts

Grid line spacing = 1.27mm

Keyswitch without fixation pins

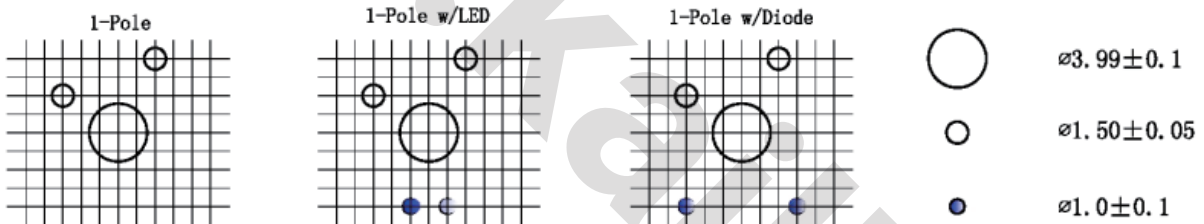

Keyswitch with fixation pins

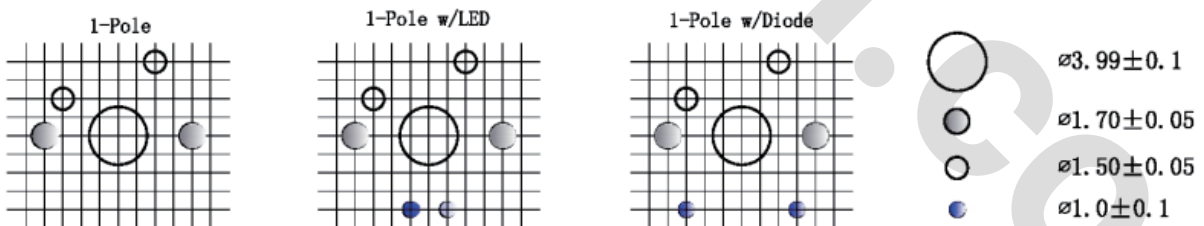

Metal Frame Cutout Dimensions

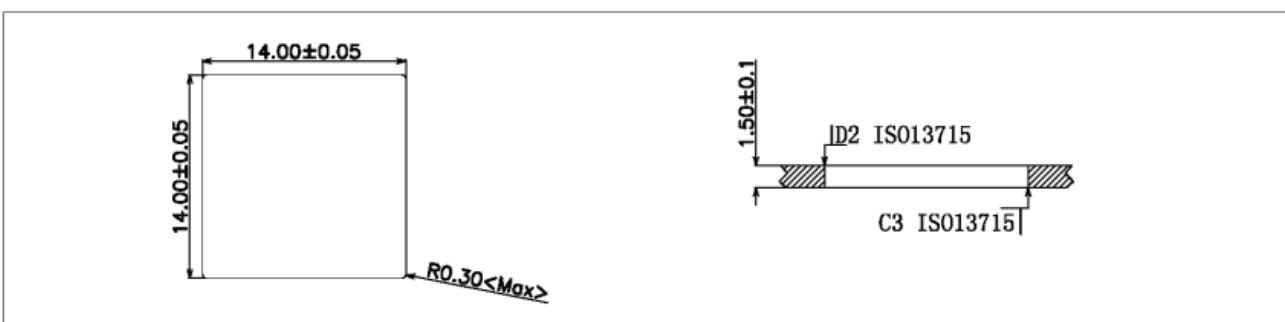

10. Loading Parameter (TT/PT/OT /OF/TF/RF) Specification

Parameter	Unit	Specification	Remark
FP	mm	15.25±0.2	
OP	mm	13.35±0.8	
PT	mm	1.90±0.60	
OF	gf	45±10	
OT	mm	0.7	Min
MD	mm	0.6	Max
CF	gf	60±10	
RF	gf	12	Min
TT	mm	3.80±0.60	

11. Precaution

11.1 Immersion Soldering condition

ITEM	CONDITION
Preheat temperature	110°C Max (Ambient temperature of soldering surface of P.W.B)
Preheat time	60s, Max
Area of flux	1/2 Max of PWB Thickness
Temperature of solder	260±5°C
Time of immersion	3±0.5s
Number of soldering	2time Max (But should down heat of the first soldering)
Printed wiring board	Single side copper-clad laminates

- (1) After switches were soldered, please be careful not to clean switches with solvent
- (2) Under the condition of using soldering iron, soldering temperature shall be 350°C ± 5 °C with 3±0.5s

11.2 Notes

- (1) Please be cautious not to give excessive static load or shock to switches.
- (2) Please be careful not to stack up P. W. B. after switches were soldered.
- (3) Preservation under high temperature and high humidity or corrosive gas should be avoided Especially.
When you need to preserve for a long period, do not open the carton.
- (4) The standard storage period is 3 months, with maximum up to 6months, preferably to be used as soon as possible.
After opening the package, you should put the remaining switches in a plastic bag to prevent from damp and corrosive gas.
- (5) This Product Specification is considered as the technical agreement on product between the receiving customer and Kailh. Any information on Product Catalogue which is in conflict with or different from the corresponding information of this document is considered as invalid.
- (6) If customer issue purchase orders without confirmation by signature of this specification after receipt, such confirmation will be considered as granted upon receipt of the first purchase order.
- (7) If there is no order or no request for new specification after 1 year upon this specification is issued, the specification will be regarded as invalid.
- (8) Products meet the ROHS & REACH environmental management substances control standards.