

Cozyla

Cozyla Canvas

Cozyla CD-3M341F

Safety, Warranty & Quick Start Guide

ⓘ Read this guide carefully before using your device.

Reading before using your device

Reading first - regulatory information

Device models equipped with wireless communications comply with the radio frequency and safety standards of any country or region in which it has been approved for wireless use. In addition, if your product contains a telecom modem, it complies with the requirements for connection to the telephone network in your country.

Be sure to read the Regulatory Notice for your country or region before using the wireless devices contained in your device. To obtain a PDF version of the Regulatory Notice, go to <https://cozyla.com/pages/regulatory-notice>.

Getting support

After the frame is installed, use your mobile phone to search for and download the My Cozyla App from Google Play Store or Apple App Store to begin the setup process. To learn more, go to <https://cozyla.com/pages/support>.

Accessing your User Guide

Your User Guide contains detailed information about your device. To download the publications for your device, go to <https://cozyla.com/pages/support> and follow the instructions on the screen.

Legal notices

Cozyla and the Cozyla logo are trademarks of Cozyla in the United States, other countries, or both.

Other company, product, or service names may be trademarks or service marks of others.

Open source information

Cozyla Canvas (the “Product”) may include software made publicly available by Cozyla, including software licensed under the General Public License and/or the Lesser General Public License (the “open source software”).

You may obtain corresponding copy of machine-readable source code for any such open source software licensed under the General Public License and/or the Lesser General Public License (or any other license requiring us to make a written offer to provide corresponding source code to you) from Cozyla for a period of three years without charge except for the cost of media, shipping, and handling, upon written request to Cozyla. This offer is valid to anyone in receipt of this Product. You may send your request in writing to the email address : **help@cozyla.com**. An email will be replied with detail instruction.

Please include the “Model” name “Serial Number” and the “Build Number” of this Product as part of your request, which can be found in the “About device” menu of the My Cozyla application installed on your mobile device.

The open source software is distributed in hope it will be useful, but WITHOUT ANY WARRANTY; without even the implied warranty of MERCHANTABILITY or FITNESS FOR A PARTICULAR PURPOSE. See for example the GNU General Public License and/or the Lesser General Public License for more information.

What's in the box

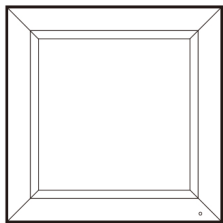

Cozyla Canvas



Stand

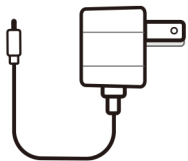

Power adapter



Safety, Warranty &
Quick Start Guide & Setup guide

ⓘ All pictures and illustrations in this document are for your reference only and may differ from the final product.

Device overview

Model name	Dimension	Resolution	Wireless communication
Cozyla Canvas Cozyla CD-3M341F	17" IPS Screen, 412.48*326.13*34.18mm (exclude stand)	1280 x 960	Wifi6 + Bluetooth 5.0; 802.11 a/b/g/n/ac/ax, 2.4GHz, 5G

When the 5G WIFI function operating in the 5150 to 5250 MHz frequency range, this device restricted to indoor use only.

Lorsque la fonction 5G WIFI fonctionne dans la gamme de fréquences de 5150 à 5250 MHz, cet appareil est limité à une utilisation en intérieur uniquement.

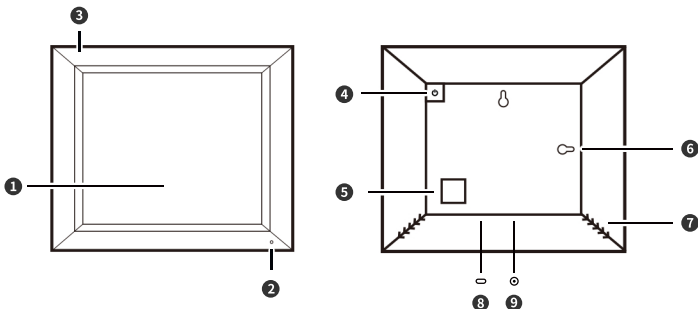

- 1** Touch screen **2** Ambient light sensor **3** Microphone
- 4** Power switch — Screen on/off (1-click) & Power on/off (long press 3s)
- 5** Bracket groove **6** Wall position **7** Speaker
- 8** Type C (Only for service) **9** DC IN

 All pictures and illustrations in this document are for your reference only and may differ from the final product.

Only used for after-sales service maintenance. Do not open the service tool cover. Doing so may cause permanent damage to the Cozyla Canvas.

Installation

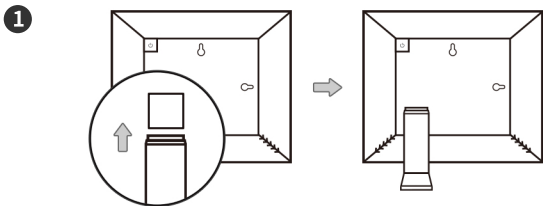

Insert the kick stand into the groove in the back of the frame. Rotate the kick stand 90 degrees to switch between landscape & portrait mode.

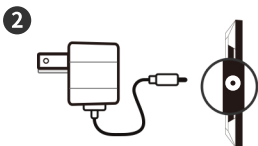

Plug the DC power cord into the frame.

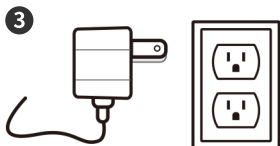

Plug the charger into the power outlet.

Download
app



Apple App Store or Google Play

You are almost there!

Create your Cozyla account and add your frame with your Mobile Phone.

Video



Setup video available at

<https://www.cozyla.com/pages/video-guide>

Gift mode setup

What is the Gift mode setup?

Gift mode setup feature allows you to customize the start up screen with a message and preload photos onto the device before you give it to the recipient. The recipient can simply power on the device and enjoy.

Giving as a gift

Before sending it as a gift, you can setup the device including startup screen, customized message, preload photos and channels, Accounts of Google Photos, Amazon Alexa and Instagram, Preset WLAN of recipient....Detail instruction can be found from

<https://cozyla.com/pages/support>.

Receiving as a gift

If the device is already setup as a gift, you can just power on the device without any setup. You can also config the device settings and WLAN with My Cozyla application.

None touch gifting

Set up the frame and gift message virtually with a sound code without opening the box, then share the code with the recipient.

Recipient's Use of the Device

The gift recipient needs to register on the My Cozyla APP, and then use the shared sound wave file or gift code to set up the device. If they want to associate or manage the device, they simply need to enter the gift code in the app to become a member or owner.

Frequently Asked Questions

<https://cozyla.com/pages/faqs>.

Touch Control

1

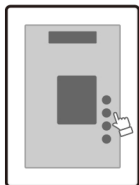

Tap the album list button to switch between albums.

2



Swipe left & right to switch photos and videos.

3

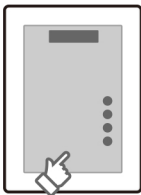

Tap the screen to display the controls.

Important safety and handling information

Cozyla Limited Warranty notice

This product is covered by the terms of the Cozyla Limited Warranty (LLW), version L5050010-02 08/2011. Read the LLW at <https://cozyla.com/pages/limited-warranty-notice>.

You can view the LLW in a number of languages from this website.

Warranty information

Cozyla provides a warranty period for your device. To check the warranty status of your device purchase upgrades, go to <https://cozyla.com/pages/limited-warranty-notice>, and then select the product and follow the on-screen instructions.

Get support

Log into My Cozyla app, get support from Cozyla by entering “ Account ” page.

Visit Cozyla’s support website (<https://cozyla.com/pages/limited-warranty-notice>) with the device serial number to get more Cozyla support options.

FCC WARNING

This device complies with part 15 of the FCC Rules. Operation is subject to the following two conditions: (1) this device may not cause harmful interference, and (2) this device must accept any interference received, including interference that may cause undesired operation.

Any changes or modifications not expressly approved by the party responsible for compliance could void the user's authority to operate the equipment.

NOTE: This equipment has been tested and found to comply with the limits for a Class B digital device, pursuant to Part 15 of the FCC Rules. These limits are designed to provide reasonable protection against harmful interference in a residential installation. This equipment generates, uses and can radiate radio frequency energy and, if not installed and used in accordance with the instructions, may cause harmful interference to radio communications. However, there is no guarantee that interference will not occur in a particular installation.

If this equipment does cause harmful interference to radio or television reception, which can be determined by turning the equipment off and on, the user is encouraged to try to correct the interference by one or more of the following measures:

- Reorient or relocate the receiving antenna.
- Increase the separation between the equipment and receiver.
- Connect the equipment into an outlet on a circuit different from that to which the receiver is connected.
- Consult the dealer or an experienced radio/TV technician for help.

To maintain compliance with FCC's RF Exposure guidelines, This equipment should be installed and operated with minimum distance between 20cm the radiator your body: Use only the supplied antenna.

IC Warning statement

This device contains licence-exempt transmitter(s)/receiver(s) that comply with Innovation, Science and Economic Development Canada's licence-exempt RSS(s). Operation is subject to the following two conditions:

1. This device may not cause interference.
2. This device must accept any interference, including interference that may cause undesired operation of the device.

L' émetteur/récepteur exempt de licence contenu dans le présent appareil est conforme aux CNR d' Innovation, Sciences et Développement économique Canada applicables aux appareils radio exempts de licence. L' exploitation est autorisée aux deux conditions suivantes:

1. L' appareil ne doit pas produire de brouillage;
2. L' appareil doit accepter tout brouillage radioélectrique subi, même si le brouillage est susceptible d' en compromettre le fonctionnement.

IC RF exposure statement:

This equipment complies with IC Radiation exposure limit set forth for uncontrolled environment.

This equipment should be installed and operated with a minimum distance of 20cm between the product and your body.

IC RF Déclaration de exposition:

Este equipo cumple con los límites de exposición a radiación por radiofrecuencia de la IC estipulados para un ambiente no controlado. Este equipo deberá instalarse y utilizarse con una distancia mínima de 20 cm entre el radiador y el cuerpo.

Set up, Easy use, Technique support, Need warranty...

We are ready to support

- Support Center: <https://www.cozyla.com/pages/help-center>
- Chat Support : my Cozyla app -> " User center " -> Contact us- > Chat with us
- Website: <https://www.cozyla.com> -> chat with us
- Email Support: help@cozyla.com
- Warranty request: <https://www.cozyla.com/pages/service-request>

© Copyright Cozyla 2024

Reduce | Reuse | Recycle

