

## BARBELL TAGS

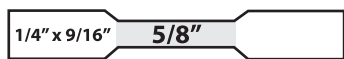

RT-1F (1/4" x 1-3/4")

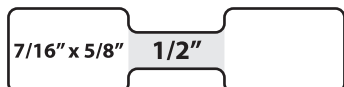

RT-77F (7/16" x 1-3/4")



RT-76F (7/16" x 1-25/32")



RT-95F (7/16" x 1-7/8")

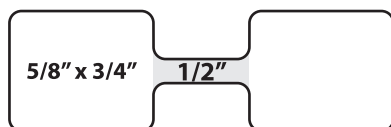

RT-68F (5/8" x 2")



RT-58F (1/2" x 2-1/8")

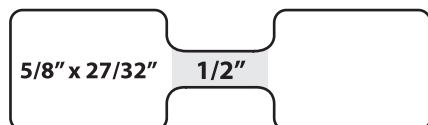

RT-56F (5/8" x 2-3/16")



RT-86F (15/32" x 2-1/2")



RT-118F (5/8" x 2-9/16")



RT-121F (5/8" x 2-15/16")

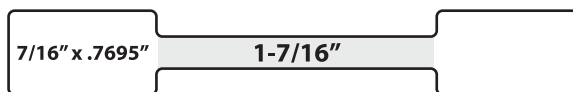

RT-119F (7/16" x 3")

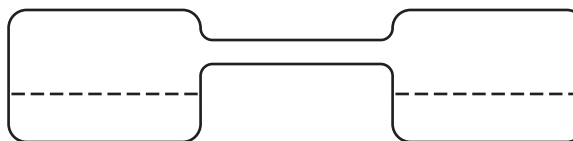

RT-128F (11/16" x 3")

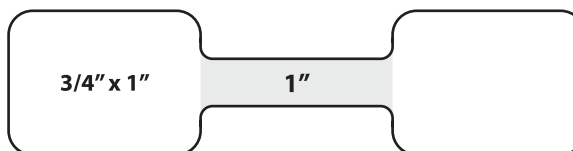

RT-116F (3/4" x 3")

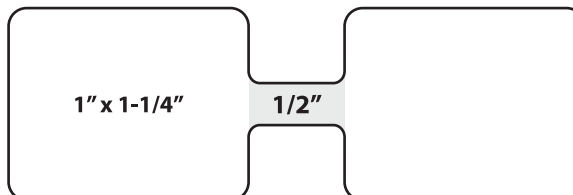

RT-135F (1" x 3")

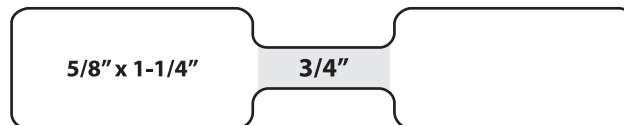

RT-96F (5/8" x 3-1/4")

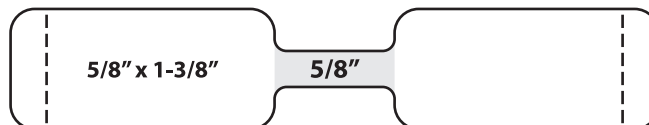

RT-99F (5/8" x 3-3/8")

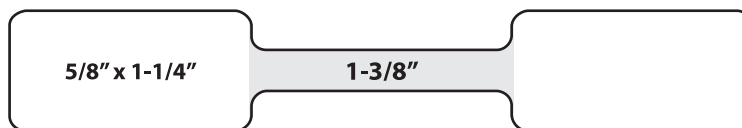

RT-97F (5/8" x 3-7/8")

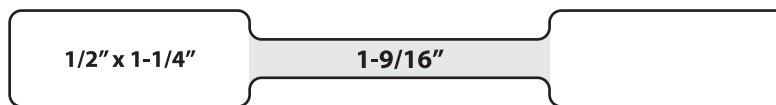

RT-98F (1/2" x 4.062")

Most sizes are available with or without adhesive in the shank area. All tags can be made in a wide variety of materials. Please note, non-adhesive area (gray shaded area) may be slightly different than shown.

**BARBELL TAGS**



**RT-19F (1/2" x 1-7/16")**

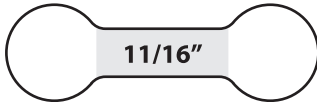

**RT-20F (1/2" x 1-5/8")**

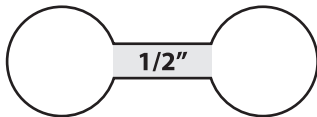

**RT-21F (9/16" x 1-5/8")**



**RT-22F (1/2" x 1-7/8")**

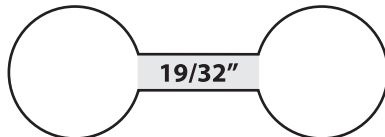

**RT-18F (11/16" x 1-31/32")**

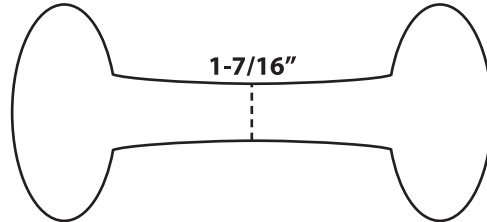

**RT-117F (1-1/8" x 2-1/2")**

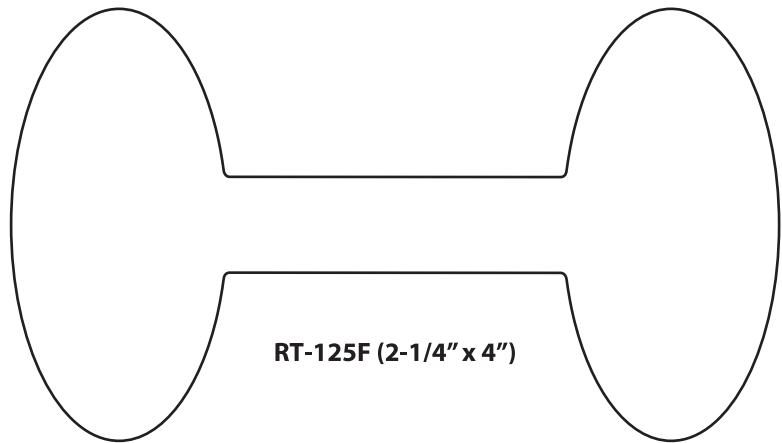

**RT-125F (2-1/4" x 4")**

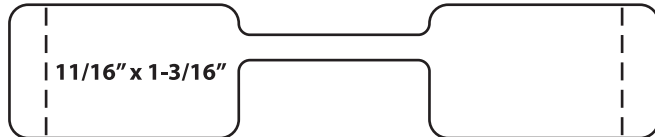

**RT-138F (11/16" x 3-3/8")**

Most sizes are available with or without adhesive in the shank area. All tags can be made in a wide variety of materials. Please note, non-adhesive area (gray shaded area) may be slightly different than shown.