

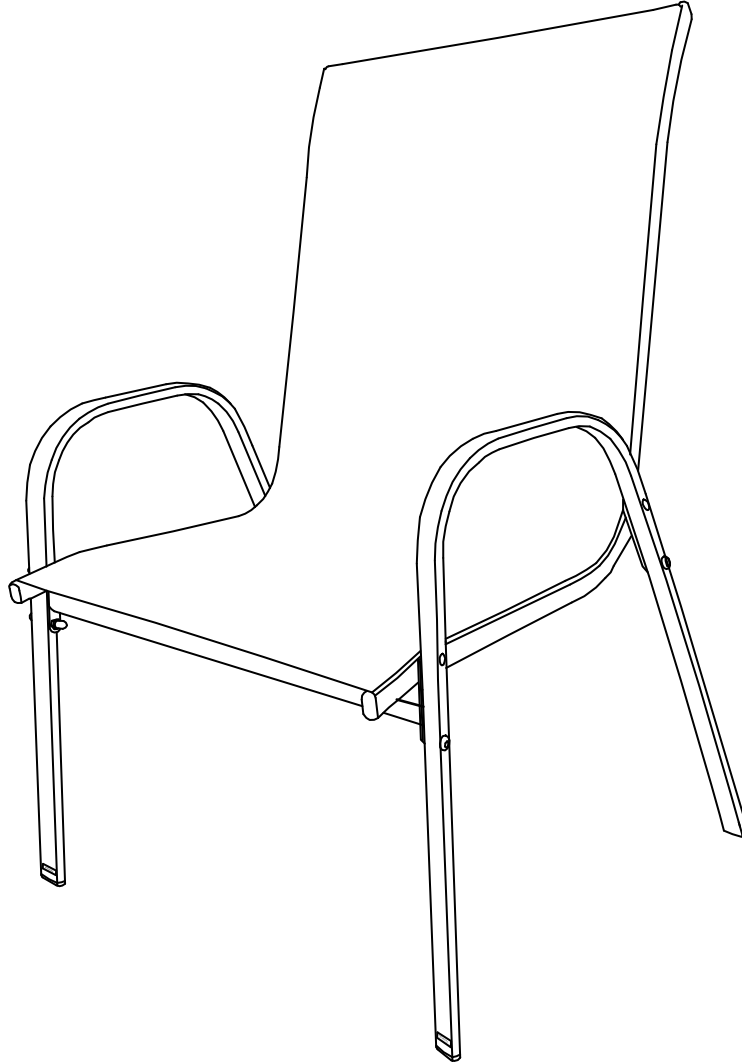





Patio Dining Chair

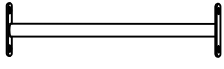
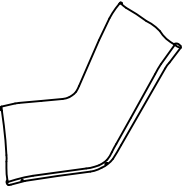

We highly value customer's user experience. Please contact us freely if there's any parts missing or damaged. We will provide professional advice or efficient customer support in 24 hours.

Parts List

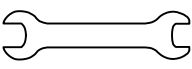
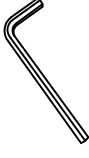
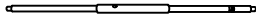
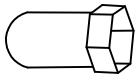
<p>A</p>  <p>1PC left front leg</p>	<p>B</p>  <p>1PC right front leg</p>	<p>C</p>  <p>2PCS</p>	<p>D</p>  <p>1PC</p>
<p>E</p>  <p>4pcs 70mm</p>	<p>F</p>  <p>4pcs 55mm</p>	<p>G</p>  <p>8PCS</p>	<p>H</p>  <p>1PC</p>
<p>I</p>  <p>1PC</p>	<p>J</p>  <p>1PC</p>	<p>K</p>  <p>8PCS</p>	

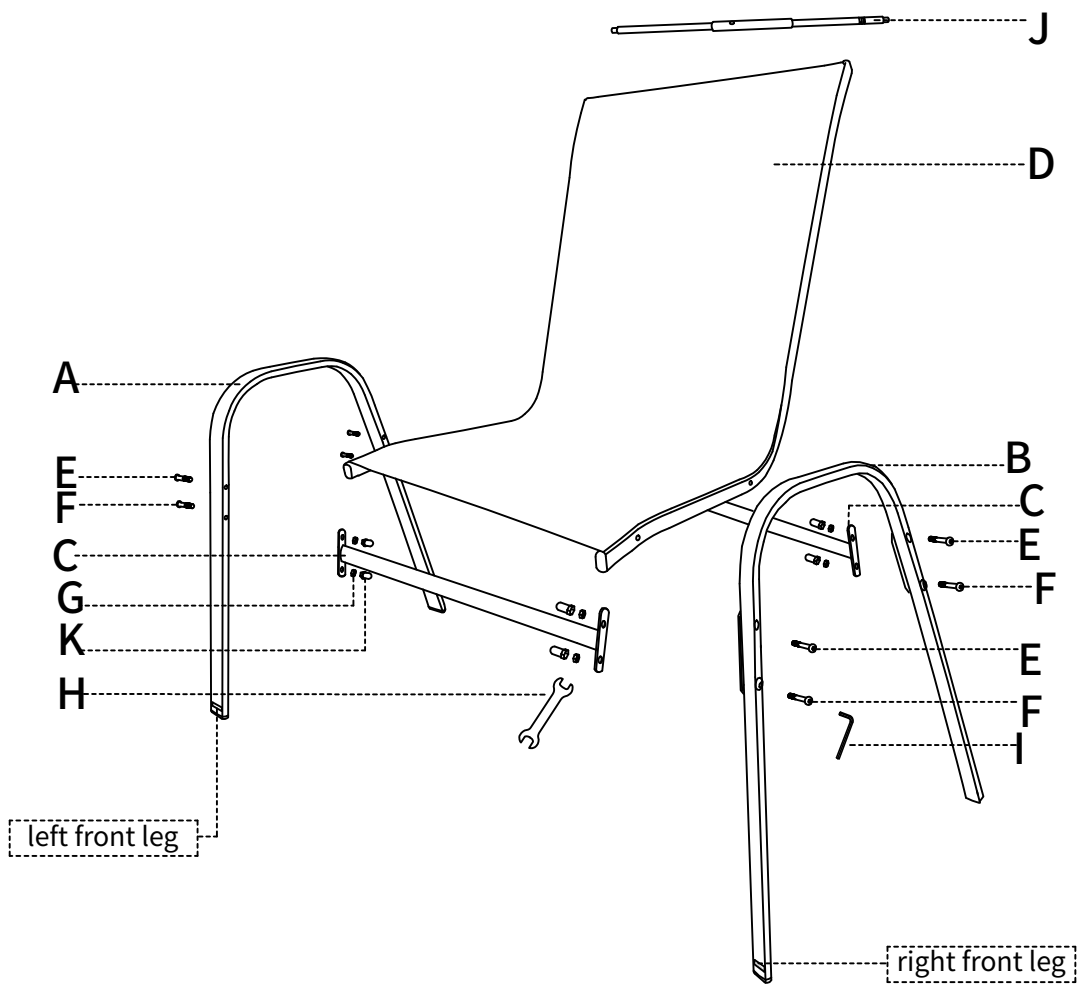

Assembly Steps

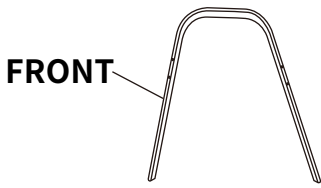



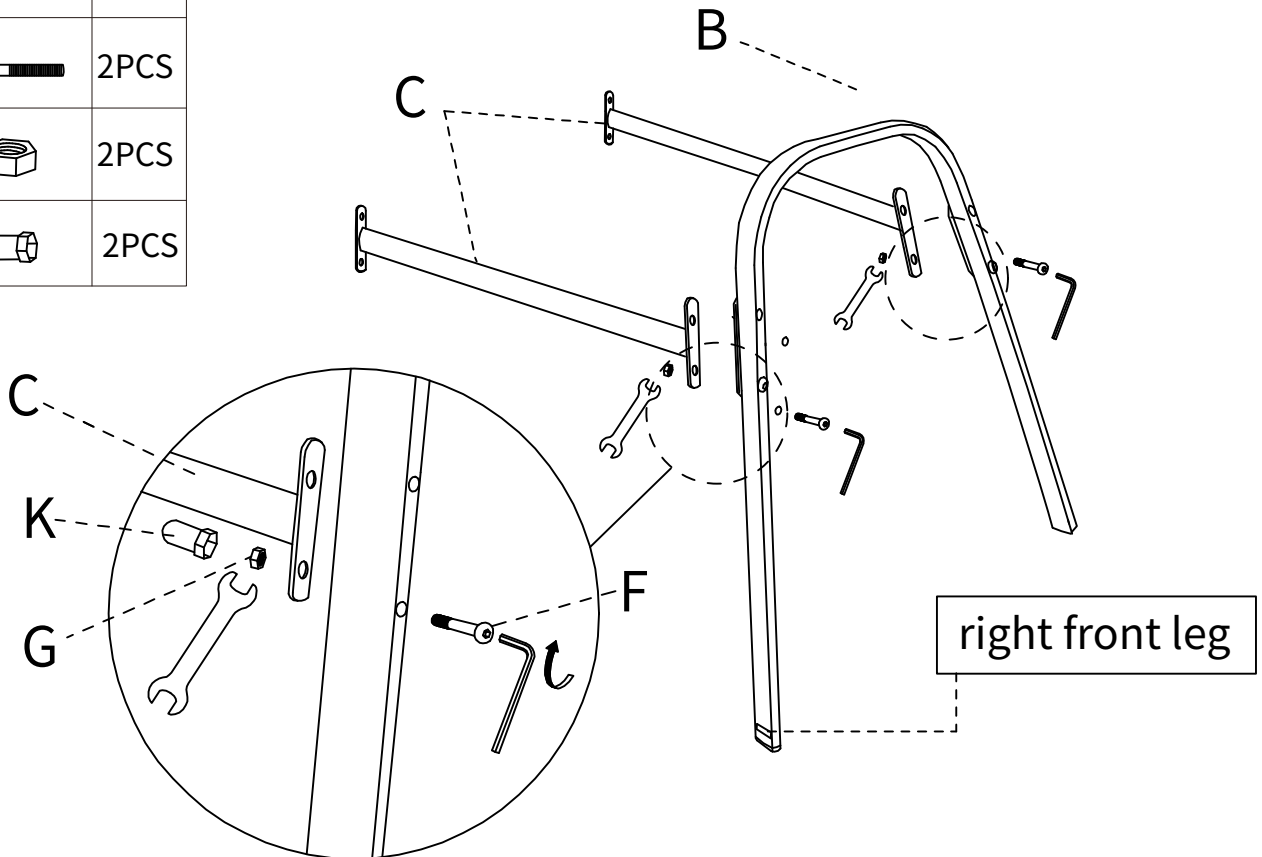

Tips: We have labeled the legs to indicate which side is the front side. However, the factory sometimes mislabeled them, please check with the picture before installing, the straighter side should be the front side.

Step 1: Connect 2 beam C and Right Leg B first. Use 2 screws F and 2 nuts G and 2 parts K to connect them. **Please don't tighten the screws yet.**

B		1PC
C		2PCS
F		2PCS
G		2PCS
K		2PCS



Step 2: Then connect the other side of beam C to Left Leg A. Use 2 screws F and 2 nuts G and 2 parts K to connect them. **Please don't tighten the screws yet.**

A		1PC
F		2PCS
G		2PCS
K		2PCS

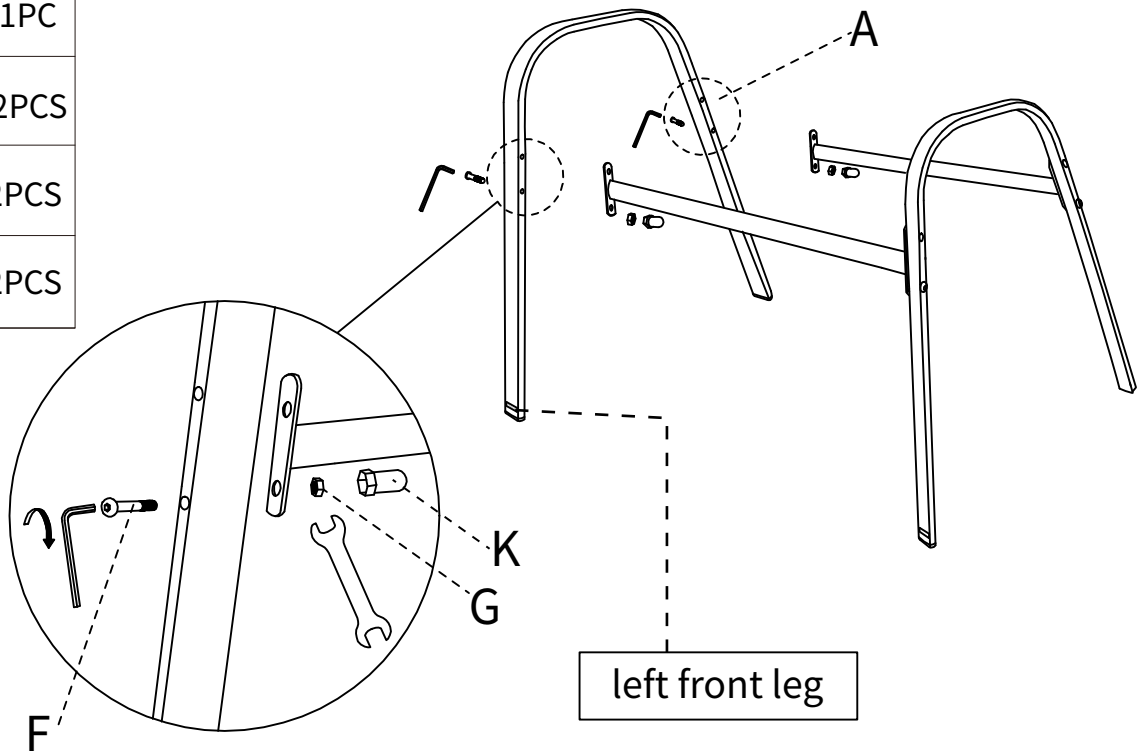

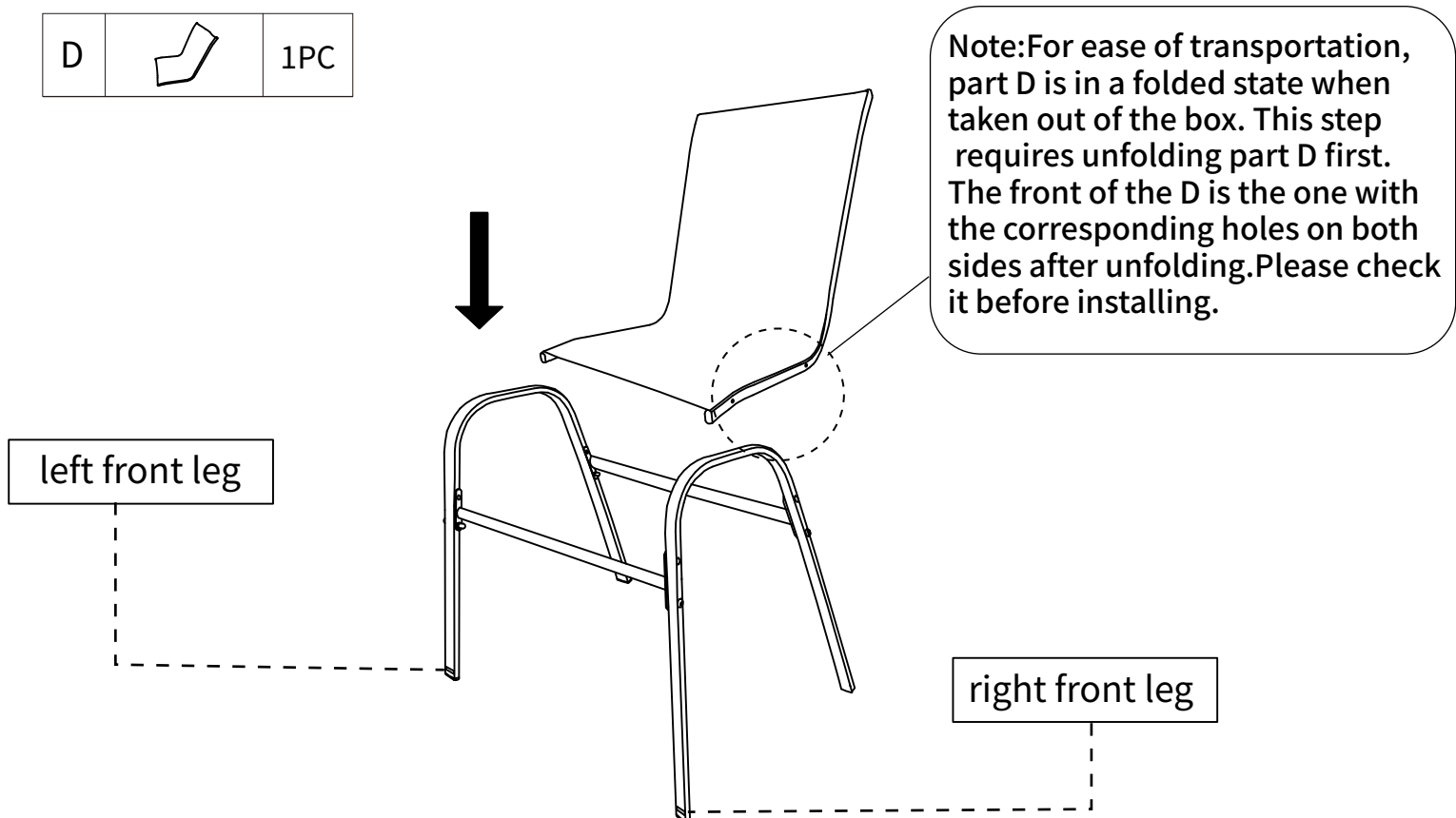

Step 3: Place part D on the installed mental frame. Align the holes in the bottom of part D with the holes in the top of beam C.

D		1PC
---	---	-----



Step 4: Use 4 screws E and 4 nuts G and 4 parts K to connect part D to the mental frame. **After this step, you can tighten each screw.**

E		4PCS
G		4PCS
K		4PCS

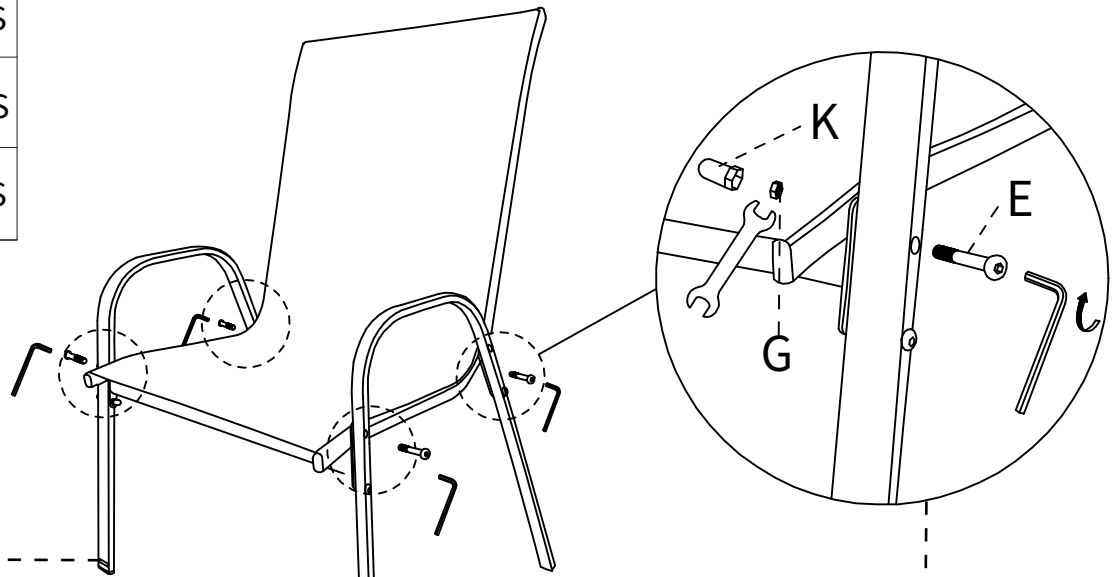

left front leg

right front leg

Note: The enlarged detail view is a perspective effect, 4 screw E should go through the holes on Legs beam C and part D to attach 4 nuts G and 4 parts K.

Step 5: Insert the rod J into the hole at the top of the part D back. Turn to tighten as indicated by the arrow.

J		1PC
---	---	-----

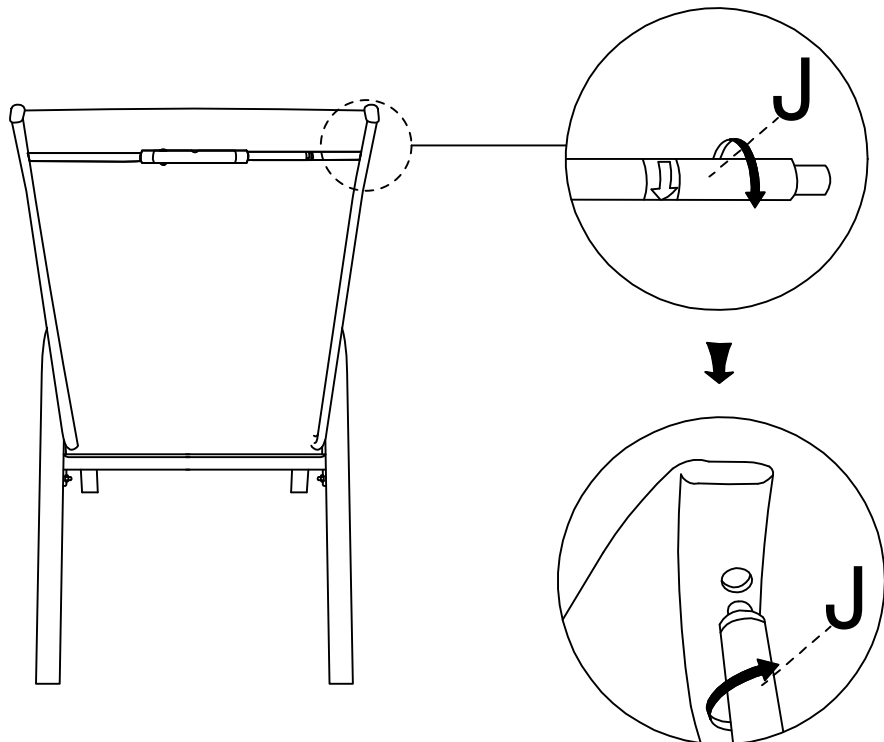

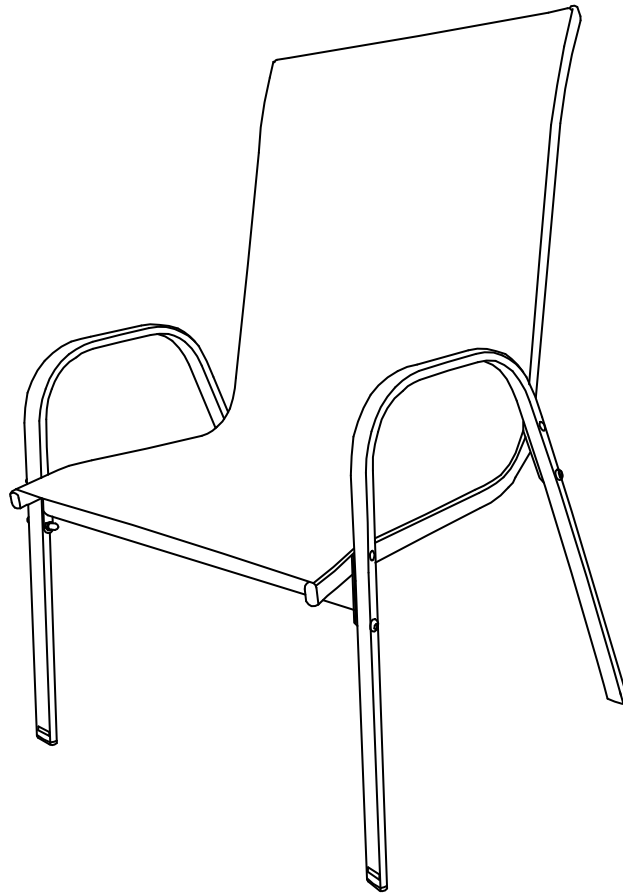

If you find that the chair is unstable and wobbly after installation, please review steps 1 and 2 of the installation. Do not tighten screws while performing steps 1 and 2. Please tighten all screws after step 4.