

PIZZA OVEN USER MANUAL

For Model **X50008**



Size(W/ D/ H): 54.1*31.5*63.5CM/21.3*12.4*25INCH

Oven weight: 10.4KG/23.0LBS

Oven floor area: 0.11 m²/1.23 ft²

Important: Retain these instructions for the future use.

STEP 7 Assemble the firewood door to the stove with screw B and nut C.

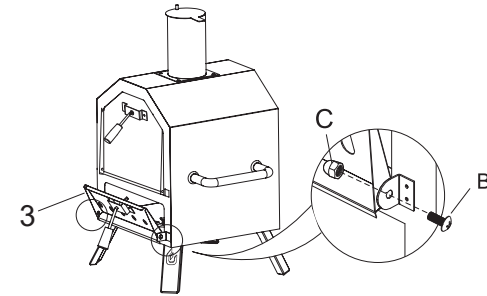

STEP 8 Place pizza stone and grill net.

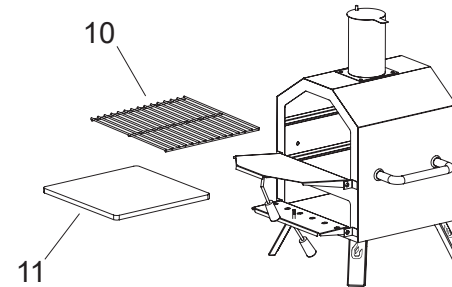

STEP 9 Assemble the peel pan 14 with the wood handle 13 with 3 pcs screw G and nuts H.

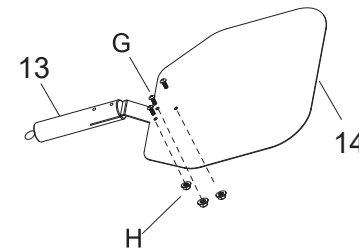

STEP 4 Assemble the chimney 1 to the stove 7 with 4 screw A.

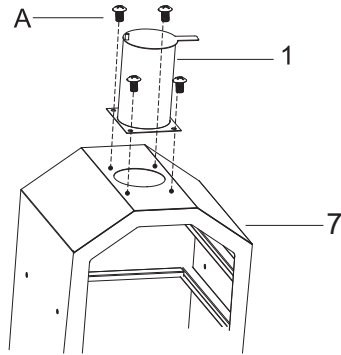

STEP 5 Assemble the handle 9 and Handle washer 8 to the oven with screw A.

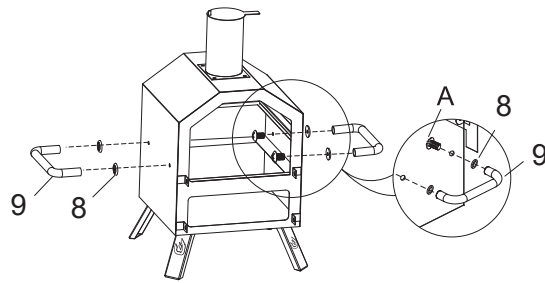

STEP 6 Assemble the door to the oven with screw B and nut C.

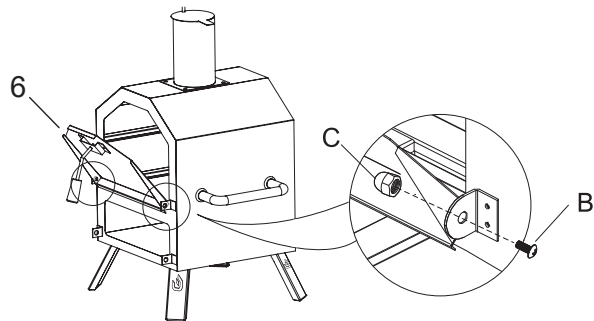

Contents Index

Warranty.....	1
Safety Legal Disclaimer.....	1
Parts List.....	2
Assembly Instructions.....	3-5

Warranty

For any queries or assistance, please send us an email. Our typical response time is 24 hours.



Customer Service
support@pizzello.com

This information may be required under the 12 months warranty.











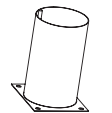
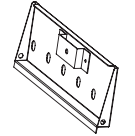
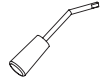

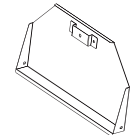



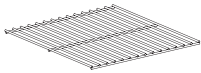

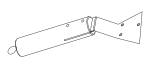
Product Model:
Order ID:
Purchase date:

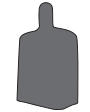
Safety Legal Disclaimer

All instructions and guidelines in this manual must be strictly followed.

1. Pizzello is only intended for usage outside. Must always be placed outside, away from structures, and never inside a building, garage, or near any enclosed space. Keep your OVEN clean and free of flammable or combustible items, fuel, and other flammable vapours and liquids by placing it on a solid, level, stable, and non-flammable surface.
2. Be aware of any local laws or regulations that may demand a certain distance between outdoor cookers and structures, or that may restrict outside cooking of any kind during drought or hazardous times.
3. Do not use or install your Pizzello in or on boats or recreational vehicles.
4. Never use your Pizzello in strong winds.
5. Your Pizzello is not designed to be a heater and should never be used as one.
6. Toxic fumes can build up and induce asphyxiation.
7. Flames can fly outside the metal enclosure from the following locations:
 - a. in the back where the fire is;
 - b. from the top of the hatch when the lid is opened;
 - c. from the front of the oven when the door is opened;
 - d. from the top of the chimney.
8. Please avoid the Pizzello's entrances and notify those near you.
9. Improper installation, adjustment, modification, repair, or maintenance of your Pizzello may result in personal injury or property damage. As a result, do not use your Pizzello until it has been entirely constructed and all pieces have been securely connected and tightened.
10. You should inspect your Pizzello on a regular basis.

Parts List

1.  Cap 1PC	2.  Chimney 1PC	3.  Firewood door 1PC	4.  Door handle 2PCS
5.  Retainer 2PCS	6.  Door 1PC	7.  Oven 1PC	8.  Handle washer 4PCS
9.  Handle 2PCS	10.  Grill 1PC	11.  Pizza stone 1PC	12.  Spring 1PC
13.  Wood handle 1PC	14.  Peel pan 1PC	15.  Cover 1PC	
A.  Screw M6*16 8PCS	B.  Stainless steel screw M6*16 4PCS	C.  Nut M6 5PCS	D.  Nut M6 2PCS
E.  Nut M6 2PCS	F.  Washer 2PCS	G.  Screw M4*8 3PCS	H.  Nut M4 3PCS

⚠ Note

Before assembly of larger pieces, you must first assemble parts as described in steps 1, 2 and 3. Please follow all instructions. Contact us if if any item is damaged or rendered defective during delivery.

Assembly Instructions

STEP 1 Assemble chimney (2) and cap (1) with screw nut C and spring 12.

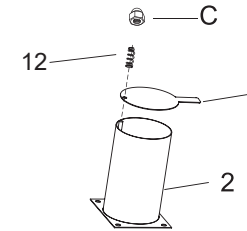

STEP 2 Assemble firewood door (3) and door handle (4) with washer F and screw nut D. Then put on the retainer (5) and fix it with screw nut E.

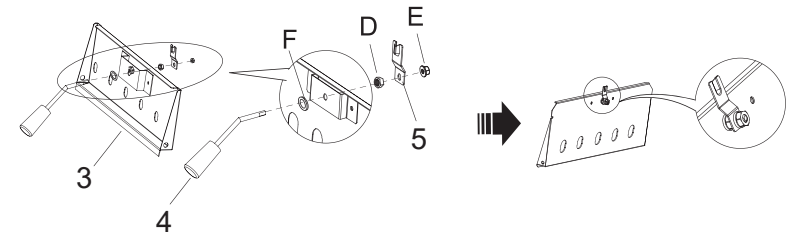

STEP 3 Assemble door (6) and door handle (4) with washer F and screw nut D. Then put on the retainer (5) and fix it with screw nut E.

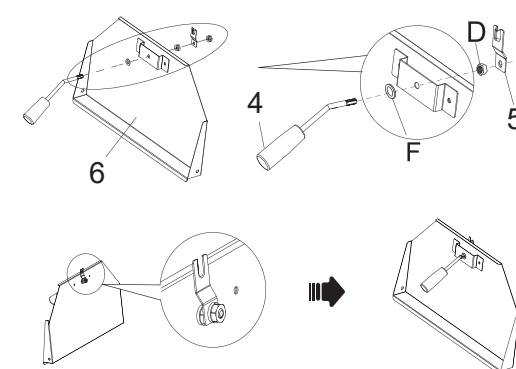

TIPS:How to clean firewood ash?

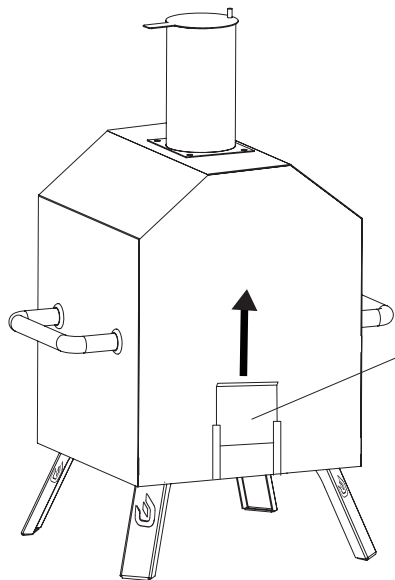

Pull up the baffle behind the stove and clean through the ash catcher

Top Reasons Why Pizza Stones Crack

1. PUTTING A COLD PIZZA STONE INTO A HOT OVEN
2. ALLOWING MOISTURE TO SEEP INTO THE PIZZA STONE
3. PLACING COOL OR COLD FOOD ONTO THE PIZZA STONE
4. HANDLING THE STONE TOO MUCH
5. REMOVING THE STONE TOO SOON FROM A HOT OVEN
6. USING TOO MUCH HEAT

How To Prevent Your Pizza Stone From Cracking In The Future

- Take frequent care and maintenance of your stone. To keep it looking nice and to protect from drips, cover with aluminum foil.
- Always place the stone into the oven when it's still cool and pre-heat it before using it.
- Avoid unnecessary handling. Moving the stone in and out of the stove too often can cause cracking.
- Don't clean with liquid or oil the stone. The moisture can cause it to split.
- Wait until rock has cooled down entirely before removing it from the oven.
- Don't place frozen pizzas on your pizza stone.
- Use a folded up towel to insulate the pizza stone from the counter when you take it out to avoid giving the stone a sudden "thermal shock".