

Alu Adjustable Hook 02

Assembly

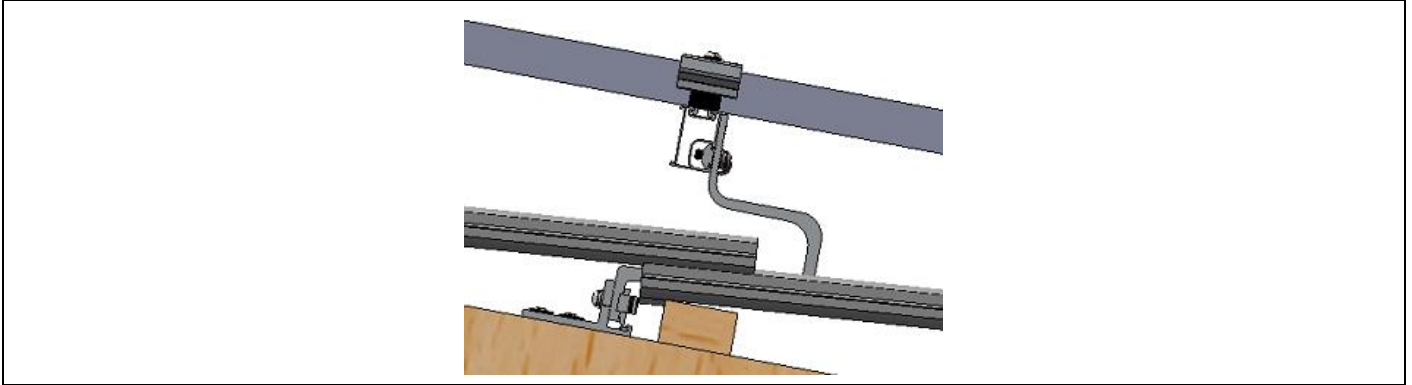

Component







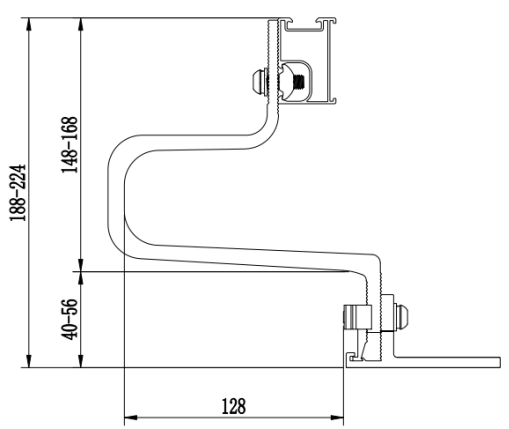

Alu Adjustable Hook 02
Part No.: ER-I-DC/02A

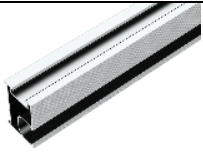
Technical Specification

| | | |
|---------------------|--|--|
| Application | Tile Roof with Timber Purlin |  |
| Screw Specification | 2 x Wood screws M8*100, T40, Electro Galvanized ETA Certification | |
| Dimensions | L150mm*W90mm | |
| Packaging | 20 units per carton | |
| Weight | 0.748 Kg | |
| Material | Main parts: AL6005-T5 Fasteners: SUS 304 | |
| Color | Silver (no less than 10 µm, excluding machined surfaces) | |
| Standard | BS EN 1990:2002 EN 1995-1-1 DIN EN 1991-1-4 DIN EN 1991-1-3 VDI 6012 Blatt 1.4 | |

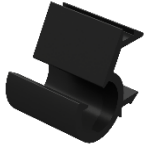
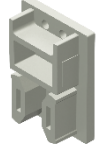
Related Components

| | | | |
|---|---|---|---|
|  |  |  |  |
| Rail | Inter Clamp | End Clamp | Grounding Lug |
| Main Material and Finish: AL6005-T5, Anodised (no less than 10 µm, excluding machined surfaces) | Main Material and Finish: AL6005-T5, Anodised (no less than 10 µm, excluding machined surfaces) | Main Material and Finish: AL6005-T5, Anodised (no less than 10 µm, excluding machined surfaces) | Main Material and Finish: AL6005-T5, Anodised (no less than 10 µm, excluding machined surfaces) |
|  |  |  |  |
| Grounding Clip | Cable Clip | Cap | Wood Screw |
| Main Material and Finish: Stainless steel SUS304 | Main Material and Finish: PA6 | Main Material and Finish: Silica gel | Main Material and Finish: Carbon Steel, Electro Galvanised |