



 **Digitek**[®]



 **ELEVATE YOUR IMAGINATIONS**

PHOTOGRAPHY CATALOGUE





ABOUT US

We aspire to be the largest technology Sales Marketing & Distribution Company. Because our customers' needs are ever changing, we understand the value of looking towards and keeping pace with the future. Our goal is to enrich our customers' personal lives with Innovation, Technology Advancements & services of superior quality.

We strive to create Sales & Profitability opportunities for vendors and resellers through innovative products, unique marketing programs, technical support and distribution & prompt after sales service while being mindful of our social and ethical responsibilities. We make a winning network of partners and build mutual loyalty.

We believe that it is the actions of individuals working together that build a strong team and that every business has an obligation to support these actions. Ours' is a great place to work where people are inspired to be the best they can be. We inspire moments of optimism. We also thrive on speed, focus and accountability. Every day, at all levels, we strive to create an environment where each individual is inclined and valued. We believe in trust, respect, teamwork, contribution and uncompromising integrity.

We are a socially responsible organization, where we work to help people save money while still buying outstanding products. We sales, market and distribute products which are green in nature helping the world protect the environment and benefit the communities in which we live and work prosper. We work towards being a responsible global citizen. We respect the law and support universal human rights.

We are proud of our success but we are never satisfied. We are building the framework for sustainable growth going forward. Anticipating your co-operation in the future, thank you all for your support to bring us where we are today.

Amit Kumar Saraff
Managing Director





led ring

Panel

Wireless

video

CONTENT

Professional Tripods, Monopods & Heads.....	04-11
Professional Bi Color & RGB LED Ring Lights	13-18
Professional Bi Color & RGB Handheld LED Light Wand	19-20
Bi Color & RGB LED Video Lights	21-23
Continuous LED Video Light	24-28
Electronic Flash Speedlite	29-30
Professional Soft Box	31-33
Flashbot Accessories	34-37
Bracket & Photographic Bag	38-39
Porta kit, Light Stand & Accessories	40-43
Electronic Dry Cabinet	44-45
Camera Accessories	46-50
Li-ion Batteries & Chargers.....	51-59
Envie Batteries & Chargers.....	60

Wireless



video light



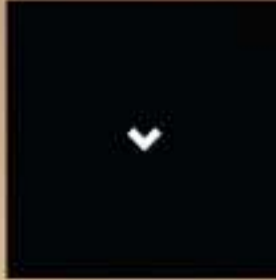

professional
**TRIPOD &
MONOPOD**

Premium Quality Tripods, Tripods Head & Monopods gives you the support and stability needed to capture tack sharp images. For Videographers, Video Tripods Provide a steady shot & seamless Pans & Zoom when filming moving images.

Nothing will do as much to improve your Photography or Film-Making as using a good Tripod or a Monopod. Not only it help you to keep the Camera Steady & Avoid blurry image but also gives a relax outdoor shoot when you are moving with camera unit. Digitek Platinum series offers you best options for Studio shoot or Outdoor. Promising good quality, Lightweight & Sturdy with advanced Features.



Platinum Professional Tripod DPTR-7060 VD

Specifications:

Maximum Load	:	20kgs
Maximum Height	:	1840mm (6 Feet)
Minimum Operating Height	:	850mm (2.7 Feet)
Folded Height	:	895mm ((2.9 Feet)
Weight of the Tripod with Head	:	4.2 Kgs (4270 gms)
Sections	:	3 (Three)
Maximum Tube Diameter	:	20 mm
Minimum Tube Diameter	:	14 mm



Platinum Professional Tripod DPTR-605VD

Specifications:

Maximum Load	:	20 Kgs
Maximum Height	:	1840mm
Minimum Operating Height	:	850mm
Folded Height	:	895mm
Weight of the Tripod	:	4.27 Kgs
Sections	:	3 (Three)
Maximum Tube Diameter	:	20 mm
Minimum Tube Diameter	:	14 mm

Platinum Professional Tripod cum Monopod DPTR-890 VD

Specifications:

Maximum Load	:	7 Kgs
Maximum Height	:	1780mm
Folded Height	:	580mm
Weight of the Tripod	:	1.63 Kgs
Sections	:	4 (Four)
Maximum Tube Diameter	:	26.6 mm
Minimum Tube Diameter	:	16.6 mm



2 Way Head with Adjustable PAN



Steady Non-Slip Foot Pad



Bubble Head to Adjust Horizontal Position



Multipurpose Head with Quick Release



Multipurpose Head with DV Camera's

Large Non-Slip Foot Pad



Detachable Non-Slip Pad, Make the Tripod Completely stable on the Ground.



Multi Purpose Head with Quick Release Plate



Two Way Head with Adjustable PAN



Bubble Head to Adjust Horizontal Position



Steady Rubberised Legs



PAN Lock



Adjust the Horizontal Center Column Position



Angle Lock



Anti Skid Rubber Foot



Tripod Cum Monopod
By Taking Down Center Column it can also be used as Monopod

-  Professional Fluid Video Head
-  Geared Center Camera
-  Bubble Head to Adjust Horizontal Position
-  Easy Clip Lock
-  Spreader & Center Column Lock Button



Platinum Professional Tripod DPTR-880 PRO

Specifications:

Maximum Load	:	7kgs
Maximum Height	:	1800mm
Minimum Operating Height	:	730mm
Folded Height	:	730mm
Weight of the Tripod	:	1850 gms
Sections	:	3 (Three)
Maximum Tube Diameter	:	30 mm
Minimum Tube Diameter	:	23 mm



-  Camera Screw Mount
-  Foam Grip
-  Easy Clip Lock
-  4 (Four) Sections
-  3 LEG Base with Ball Head Movement



Platinum Professional Monopod DPMP-172 B

Specifications:

Maximum Load	:	10 Kgs
Maximum Height	:	1700mm
Minimum Operating Height	:	675mm
Folded Height	:	675mm
Weight of the Tripod	:	1295gms.
Sections	:	4 (Four)
Tube Diameter	:	32 mm



get YOUR
CAMERA IN
ACTION



2 Way Head with Adjustable PAN



Multipurpose Head with Quick Release



Bubble Head to Adjust Horizontal Position



Independent PAN Lock



Platinum Professional Video Head DPVH-130

Bridge-Based Professional "Fluid Head" for perfect Camera movement

Specifications:

Max Height	: 110mm (0.32) Feet
Tilting Angle	: -70° / +90°
Rotation Angle	: 360°
Screw of Quick	: 1/4 inch & 3/8inch
Release Plate	: Screw
Color	: Black and Red
Loading Weight	: 10Kgs
Net Weight	: 900 gms



2 Way Head with Adjustable PAN



Multipurpose Head with Quick Release



Bubble Head to Adjust Horizontal Position



Independent PAN Lock



Platinum Professional Video Head DPVH-110

Specifications:

Max Height	: 110mm(0.32) Feet
Tilting Angle	: -70° / +90°
Rotation	: 360°
Screw of Quick	: 1/4 inch & 3/8inch
Release Plate	: Screw
Color	: Black and Blue
Loading Weight	: 10Kgs
Net Weight	: 900 gms

Bridge-Based Professional "Fluid Head" for perfect Camera movement



Quick Release Plate With Safety Lock



+90°~70° Adjustable Pitch Knob



Adjustable Quick Release Plate Design



Bubble Head to Adjust Horizontal Position



Platinum Quick Release Plate DQRP-001

Feature

- Can be used with Tripod, Rail, Stabilizer & different devices for Photography.
- Compatible for Manfrotto 501, 500AH, 701HDV, 577, etc.
- Fast switching between different devices without replacing the quick release assembly.
- Made of Aluminum Alloy & very Durable.
- Combination of a Quick Release Clamp adapter & Quick Release Plate.

Specifications:

Material	: Aluminum alloy
Item Size	: 12 * 9.3 * 2.2cm / 4.7 * 3.7 * 0.9in
Item Weight	: 271g / 9.6oz
Package Size	: 12.5 * 11 * 3cm / 4.9 * 4.3 * 1.2in
Package Weight	: 292g / 10.3oz

**Professional DV Tripod cum Monopod
DTR-500 BH**

Specifications:

Maximum Load Upto	: 7Kgs.
Maximum Height	: 1510mm
Minimum Height	: 320mm
Folded Height	: 445mm
Weight	: 1.44Kgs
Sections	: 4 (Four)

**Professional DV Tripod cum Monopod
DTR-520 BH**

Specifications:

Maximum Load Upto	: 7Kgs.
Maximum Height	: 1510mm
Minimum Height	: 320mm
Folded Height	: 445mm
Weight	: 1.44Kgs
Sections	: 4 (Four)

**Professional DV Tripod
DTR-690VD PRO**
Portable & Sturdy for DV Camera

Specifications:

Maximum Load Upto	: 6 Kgs.
Maximum Height	: 2090mm
Minimum Height	: 740mm
Folded Height	: 740mm
Maximum Tube Diameter	: 30mm
Minimum Tube Diameter	: 20mm
Weight	: 2.15 Kgs
Sections	: 4 (Four)



Ball Head



Bubble Head to Adjust Horizontal Position



Multi Purpose Head with Quick Release



Ideal for Low Level/ Macro & Panning Photography



Easy to use it as Monopod
One Leg of Tripod have a pin engraved with the identity of the open unlock, the feet can be screwed out and connect with center tube working as shown



Ball Head



Bubble Head to Adjust Horizontal Position



Multi Purpose Head with Quick Release



Ideal for Low Level/ Macro & Panning Photography



Easy to use it as Monopod
One Leg of Tripod have a pin engraved with the identity of the open unlock, the feet can be screwed out and connect with center tube working as shown

2 Way Head with Adjustable PAN



Bubble Head to Adjust Horizontal Position



Multi Purpose Head with Quick Release



Steady Rubberised Leg



Flip Locking System for Fast Setup



Ultra

PORTABLE & PROFESSIONAL
HEAVY DUTY TRIPOD

Lightweight DV Tripod DTR-550 LT / LW Portable & Sturdy for DV Camera

Specifications:

Maximum Load Upto	: 5Kgs.
Maximum Height	: 1700mm
Minimum Height	: 615mm
Folded Height	: 615mm
Maximum Tube Diameter	: 26.5 mm
Minimum Tube Diameter	: 20 mm
Weight	: 1.20Kgs
Sections	: 3 (Three)

Professional DV Tripod DTR-590 VD PRO Portable & Sturdy for DV Camera

Specifications:

Maximum Load Upto	: 6 Kgs.
Maximum Height	: 1800mm (5.90 Feet)
Folded Height	: 730mm
Maximum Tube Diameter	: 30mm
Minimum Tube Diameter	: 23mm
Weight	: 1850gms
Sections	: 3 (Three)

Light Weight DV Tripod DTR-480 LW

Specifications:

Maximum Load Upto	: 2Kgs.
Maximum Height	: 1450mm (4.75 Feet)
Folded Height	: 520mm
Maximum Tube Diameter	: 20mm
Minimum Tube Diameter	: 13mm
Weight	: 0.61 Kgs
Sections	: 3 (Three)

Light Weight DV Tripod DTR-455 LT

Specifications:

Maximum Load Upto	: 3Kgs.
Maximum Height	: 1300mm (4.26 Feet)
Folded Height	: 450mm (1.74 Feet)
Maximum Tube Diameter	: 20mm
Minimum Tube Diameter	: 11mm
Weight	: 480gms (0.48Kg)
Sections	: 4 (Four)

DV Head

Height: 103 mm, Length: 80 mm, Width: 110 mm, Handle Length: 245 mm, Material: Plastic, Weight: 0.28 kg, Loading Weight : 8 kgs

-  3 Way Head with Adjustable PAN
-  Bubble Head to Adjust Horizontal Position
-  Multi Purpose Head with Quick Release
-  Steady Rubberised Leg
-  Convenient Accessory Hook



" Mobile Phone Holder"
Included with
DTR-550 LW



-  2 Way Head with Adjustable PAN
-  Bubble Head to Adjust Horizontal Position
-  Multi Purpose Head with Quick Release
-  Steady Rubberised Leg
-  Convenient Accessory Hook



-  3 Way Head with Adjustable PAN
-  Easy Flip Lock & Rubberised Legs
-  Bubble Head to Adjust Horizontal Position
-  Multipurpose Head with Quick Release



" Mobile Phone Holder"
Included in the pack



-  Steady Rubberised Legs
-  3 Way Head with Adjustable Pan
-  Easy Flip Lock
-  Multi Purpose Head with Quick Release
-  Bubble Head to Adjust Horizontal Position



Phone Clip Holder
included in the
Package



-  Ball Head with 1/4 inch Screw Connector
-  Anti Skid Rubber Feet
-  3 (Three) Leg Base
-  Push Button with 5 (Five) Segment



Portable Mini Tripod DTR-200 MT With 3 Leg Base

Specifications:

Maximum Load Up to	: 1Kg
Maximum Operating Height	: 200mm (7.87inch)
Minimum Operating Height	: 130mm (5.11inch)
Folded	: 215mm (8.46inch)
Weight	: 141 gms
Sections	: 2(Two)

-  360° Free Rotation
-  Accommodate Most Smartphone up to 8CM
-  Stainless Steel 5 Section Grooved Rod
-  Bluetooth 4.0 Remote to Click Photos
-  Stable 3 Leg Stand



Selfie Stick with Bluetooth Remote DTR-210 SS With 3 Leg Base

Specifications:

Maximum Load Up to	: 1Kg
Maximum Operating Height	: 680mm(9.44inch)
Folded	: 210mm (10.23inch)
Weight	: 110 gms
Sections	: 5 (Five)
Material	: Plastic

-  Ball Head with Adjustable Pan
-  Anti Skid Rubber Feet
-  Mobile Phone Holder
-  Bluetooth Remote to Click Photos
-  Multipurpose Head with Quick Release



Portable Gorilla Tripod DTR-260 GT With 3 Leg Base

Specifications:

Maximum Load Up to	: 1Kg
Maximum Operating Height	: 240mm (9.44inch)
Folded	: 260mm (10.23inch)
Weight	: 149 gms
Sections	: 10 (Ten)
Material	: Plastic

-  Ball Head with 1/4 inch Screw Connector
-  Flexible Legs
-  Cold Shoe Mount For extensions like Microphone and LED light
-  Wide Compatibility For Smartphone sizes Upto 8cm



Flexible MINI Tripod DTR-320 FT

Specifications:

Maximum Load Up to	: 3Kgs.
Maximum Height	: 270mm (4.75 Feet)
Folded Height	: 320mm
Weight	: 0.380 Kgs

Professional Monopod
DMP 60
 with 4 Extendable Sections

Features:

Comfortable, Rounded Rubber Hand Grip. Made of strong yet lightweight Digitek Monopod offers a collapsible design where the handle rotates down, the legs contract and everything folds in, creating a short, compact size. Built in cushion grip and Anti-slip rubber base for better stability. This lightweight Monopod provides support and stabilization when using your camera or camcorder for sports, events and more.

Specifications:

Maximum Load Up to	: 5Kgs.
Maximum Height	: 1570mm
Minimum Height	: 620mm
Folded	: 620mm
Weight	: 1.2Kgs
Sections	: 4 (Four)

Professional Monopod
DMP 75L
 with 4 Extendable Sections

Features:

Lightweight Aluminum Telescopic Camera Monopod with Tripod Base for DSLR Video Cameras. Ultra portable & Heavy duty. Made of strong yet lightweight aluminum. this Monopod transitions effortlessly from one spot to another & transports easily. Its collapsible design where the handle rotates down, the legs contract and everything folds in compact size. Fits neatly into the provided zippered bag for easy portability and safe storage.

Specifications:

Maximum Load Up to	: 5-8Kgs.
Maximum Height	: 1700mm (5.57 Feet)
Minimum Height	: 600mm (1.96 Feet)
Folded	: 600mm (1.96 Feet)
Tube Diameter	: 32 mm
Weight	: 0.895 Kg
Sections	: 4 (Four)



Screw Mount for Video Head/Camera



Perfect Foam Grip



Non Slip Flip Lock



Anti Slip Rubber Base



Switch to 1/4 and 3/8 inch Screw Mount for Video Head & Camera



Rounded Rubber Grip



Easy Flip Lock



Retractable 3 Leg Base



BEAT *The*
CROWD

Capture any moment without any hassle



 M 1/4
Camera
Screw

 Bubble Head
To adjust
Horizontal Level

 Locking Knob
for Quick
Release Plate

 Hollow
Ball

Lightweight Ball Head DVH-002 PRO with Quick Release Plate

- DigiTek Ball Head DVH-002 is an ideal Ball Head with Adjustable Pan Bar.
- Equipped with Safety Lock Knob for Quick Release Plate to avoid accidental release of Camera from mount.
- Bubble Level to adjust horizontal position.
- With 360° swivel gives better solution for the Video or Panoramic Shoot.

Specifications:

Maximum Load	: 8 Kgs
Maximum Operating Height	: 90mm
Weight	: 350gms

 Quick Release
Multipurpose
Head

 Bubble Head
To adjust
Horizontal Level

 Locking Knob
for Vertical
Damping

 Locking Knob
for Horizontal
Damping



Professional Video Head DVH-001 with PAN & Tilt Function

Ball Head DVH-001 Pro is lightweight PAN Head made of ABS with Quick Release Plate & Handle Grip for Smooth & Professional shooting. PAN Tilt +50/-90 degree can be fixed through locking knob. Having 1/4 inch screw suitable for most camera & Camcorder. Also locking knob for Horizontal & Vertical Damping. 360° degree locking knob for Panoramic Shots.

Specifications:

Maximum Load	: 5 Kgs
Maximum Operating Height	: 110mm
Weight	: 500gms

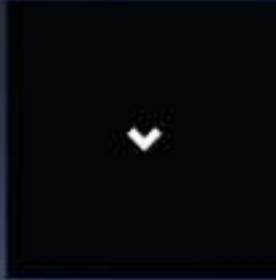



professional
**LED RING
LIGHT,
VIDEO LIGHT &
CONTINUOUS LIGHT**

Light Weight, Slim & consume less energy. Safe while taking Closeup Shoots. Its Continuous Light Source eliminates Red Eye Effects caused by Camera Flashes.



Platinum LED Ring Light DPRL-19 RGB Dual / RGB Color Temperature

DRL 19 RGB with No Shadow apertures, is essentially a boon for Photo-Video shoots with RGB Lighting effects. This Bi-color plus RGB Light source is oasis at places like mMarket, Beach, Park or any outdoor for amazing results. Also ideal for Make-up Artists & Fashion Photographers. Perfect light to shoot Interviews, Food / Product Shots, V-logs, Documentaries & much more. Can mount it to a Grip Head or Light Stand. Stepless Adjustment for Color Temperature to maintain product tone or create fine subject details

Operational Instruction

1. Please take out the light from the bag, insert the Power Line into the Plug & connect to AC Power Source
2. Rotate the Knob Clockwise to turn ON the Light. On Rotating further the Light become brighter

Specifications:

Input	: 110V/220 50HZ/60HZ
Output Power	: 60 Watt
Luminance	: 6000 LM
Color Temperature	: 2700K-6500K plus RGB RA>97
LED	: 480 (400 Bi color & 80 Pcs RGB)
Diameter	: Outer 450mm, Inner 360mm
Weight	: 1.25 Kg (Approx)

LED Ring Light DRL-18 RGB Dual / RGB Color Temperature

LED Ring Light DRL 18 RGB with No Shadow apertures, is essentially a boon for Photo-Video shoots with RGB Lighting effects. This Bi-color plus RGB Light source is oasis at places like market, beach, park or any outdoor for amazing results. Also ideal for Make-up artists & Fashion photographers. Perfect light to Shoot Interviews, Food / Product shots, V-logs, Documentaries & much more. Can mount it to a Grip Head or Light Stand as per need. It has Stepless Adjustment for Color Temperature to maintain product tone or create fine subject details.

Specifications:

Input	: 110V/220 50HZ/60HZ
Output Power	: 60 Watt
Luminance	: 5400 LM
Color Temperature	: 3200K-5600K Plus RGB
Diameter	: Outer 450 - Inner 360mm
LED Bulbs	: 480 (400+ 80 RGB)

LED Ring Light with Light Stand DRL-15C RGB Dual / RGB Color Temperature

DRL 15C RGB with No Shadow apertures, is essentially a boon for Photo-Video Shoots with RGB Lighting effects. This Bi-color plus RGB Light source is oasis at places like Market, Beach, Park or any outdoor for amazing results. Also ideal for Make-up artists & Fashion Photographers. Perfect light to shoot interviews, Food / Product shoots, V-logs, Documentaries & much more. Can mount it to a Grip Head or Light Stand. Stepless Adjustment for Color Temperature to maintain product tone or create fine subject details.

Specifications:

Input	: 110V/220 50HZ/60HZ
Output Power	: 30 Watt
Luminance	: 2700 LM
Color Temperature	: 2800K-6500K plus RGB
Diameter	: 330mm
Weight	: 1.18Kg
LED Bulbs	: 168 Pcs

5 FEET LIGHT STAND Features

Digitek Lightweight Stand DLS-005FT for Indoor & Outdoor Photographic Lighting. Solid & Sturdy Reverse Folding Light Stand with Screw Lock & Height Adjustment. 4 sections structure. 1/4 inch mounting thread & shock absorption spring for stable shoot.



Power Interface

LCD Display

Rotation

USB Phone Charging

Bi-Color Left & Right Button

* Light Stand not included with Pack



Switch between RGB & Voice Rhythm with RGB Speed Control

ON/ OFF with Brightness Control Button

Rotation

Power Interface

USB Phone Charging

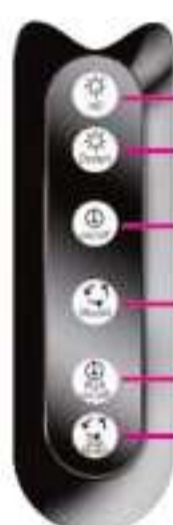

Brightness +

Brightness -

ON / OFF

Color Temperature Switch

RGB ON/OFF

RGB MODEL



1/4 inch Mounting Thread



Easy Screw Lock



4 Sections

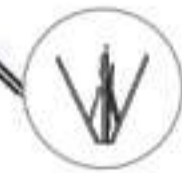

Easy & Quick Folding



Platinum LED Ring Light DPRL-19 RT Dual Color Temperature

DPRL-19RT with No Shadow apertures, is essentially a boon for Photo-Video shoots. Works on AC power. This Bi-color light source is oasis for amazing results. Ideal for Make-up artists & Fashion photographers, Video Shoot, You tube Videos etc. Perfect light to shoot interviews, food / Product shots, V-logs, Documentaries & much more. Can mount it to a Grip Head or Light Stand as per need. It has Stepless Adjustment for Color Temperature to maintain product tone or create fine subject details.

Operational Instruction

1. Please insert the AC Cable into the plug & connect to AC Power Source
2. Adjust the Brightness & Color Temperature with Function Button in Remote

Specifications:

Input	: 110V/220 50HZ/60HZ
Output Power	: 80 Watt
Luminance	: 7200 LM
Color Temperature	: 3200K-5600K
LED	: 480 Pcs

Platinum LED AC / DC Ring Light DPRL-19 H Dual Color Temperature

DPRL-19H with No Shadow apertures, is essentially a boon for Photo-Video shoots at No Electrical Power Supply Spot too. Works on both AC & DC power. This Bi-color light source is oasis at place like Market, Beach, Park or any outdoor for amazing results. Ideal for Make-up Artists & Fashion photographers, Video Shoot, You tube Videos etc. Perfect light to shoot Interviews, Food / Product shots, V-logs, Documentaries & much more. Can mount it to a Grip Head or Light Stand as per need. It has Stepless Adjustment for Color Temperature to maintain product tone or create fine subject details. Runs on 2 optional NP-F550 / 750 / 960 Li-ion Batteries.

Operational Instruction

1. Please insert the AC Cable into the plug & connect to AC Power Source
2. Rotate the Knob Clockwise to Turn on the Light. on Rotating Further the light become brighter.

Specifications:

Input	: 110V/220 50HZ/60HZ
Output Power	: 80 Watt
Luminance	: 7200 LM
Color Temperature	: 3200K-5600K
Adjustment Range	: Stepless Adjustment
LED	: 480 Pcs
Compatible Battery	: NP-F550 / F750 / F960

Platinum LED Ring Light DPRL-18 Dual Color Temperature

Digitek Platinum LED Ring Light DPRL-18 with No Shadow apertures, is essentially a boon for Photo-Video shoots. Works on AC power. This Bi-color Light source is oasis at places like Market, Beach, Park or any outdoor. Ideal for Make-up artists & Fashion photographers, Shoot Interviews, Food & Product shoots, V-logs, Documentaries & much more. Can mount it to a grip head or Light stand as per need. It has Stepless Adjustment for Color Temperature to maintain product tone or create fine subject details.

Operational Instruction

1. Please insert the AC Cable into the plug & connect to AC Power Source
2. Rotate the knob clock wise to Turn on the Light. On Rotating further the light becomes brighter.

Specifications:

Input	: 110V/220 50HZ/60HZ
Output Power	: 80 Watt
Luminance	: 7200 LM
Color Temperature	: 3000K-6500K
Adjustment Range	: Stepless Adjustment
LED Quantity	: 432
Flash Index	: RA>85
Dimmer	: 10%-100%





Power Button & AC Socket



Hotshoe Connector



Rotation



USB Phone Charging



2 Separate Intensity & Color Temperature Adjusting Knob



2 Battery Input Slots for NP-F Series Batteries



LED AC / DC Ring Light DRL-18H Dual Color Temperature

Bi-Color LED Ring Light is a distinctive-shaped source with a signature quality of Light. Soft, slightly directional look or you can mount it to a Grip Head or Light Stand & shoot through it for a silky smooth near-shadowless effect. Runs on 2 optional Sony NP-F550 / 750 / 960 Li-ion batteries. DRL-018 shows no shadow aperture by the Ring Structure. Made up of 240 pieces High Quality SMD LED Lamps, with Stable Color Temperature. Built-in temperature protection protects the electronic circuit.

Specifications:

Input	: 110V/220 50HZ/60HZ
Output Power	: 60 Watt
Luminance	: 5400 LM
Color Temperature	: 3200K-5600K
Battery	: NP-F550 / 750 / 960 lithium-ion
Weight	: 1.1Kg



Power Button & AC Socket



Hotshoe Connector



Rotation



USB Phone Charging

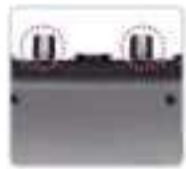

2 Separate Intensity & Color Temperature Adjusting Knob



2 Battery Input Slots for NP-F Series Batteries



LED Ring Light with 6 Feet Light Stand DRL-18H C 6 Dual Color Temperature

Digitek DRL-18H C is a Bi-Color LED Ring Light is a distinctive-shaped source with a signature quality of Light. Soft, slightly directional look or you can mount it to a Grip Head or Light Stand & shoot through it for a silky smooth near-shadowless effect. Runs on 2 optional Sony NP-F550 / 750 / 960 Li-ion batteries. With no shadow aperture by the Ring Structure. Made up of 240 pieces High Quality SMD LED Lamps, with Stable Color Temperature. Built-in temperature protection protects the electronic circuit.

Specifications:

Input	: 110V/220 50HZ/60HZ
Output Power	: 60 Watt
Luminance	: 5400 LM
Color Temperature	: 3200K-5600K
Battery	: NP-F550 / 750 / 960 lithium-ion
Weight	: 1.1Kg

Digitek Light Stand DLS-006FT

Digitek 6 Feet Light Stand are lightweight & stable option for indoor & outdoor Photographic Lighting.

Sturdy & Solid Lighting Tripod stands with easy Flip Lock & Height adjustment with its 3 Sections structure.

1/4 inch mounting thread and **Shock absorption Spring** for stable shoot.

Compatible with Ring Light, Flash, Light Lamps, Reflectors, Umbrellas etc.



Power Button & AC Socket



Hotshoe Connector



Rotation



USB Phone Charging



2 Separate Intensity & Color Temperature Adjusting Knob



2 Battery Input Slots for NP-F Series Batteries



LED Ring Light with 9 Feet Light Stand DRL-18H C 9 Dual Color Temperature

Digitek DRL-18H C 9 is a Bi-Color LED Ring Light is a distinctive-shaped source with a signature quality of Light. You can mount it to a Grip Head or Light Stand & shoot through it for a silky smooth near-shadowless effect. Runs on 2 optional Sony NP-F550 / 750 / 960 Li-ion batteries. With no shadow aperture by the Ring Structure. Made up of 240 pieces High Quality SMD LED Lamps, with Stable Color Temperature.

Specifications:

Input	: 110V/220 50HZ/60HZ
Output Power	: 60 Watt
Luminance	: 5400 LM
Color Temperature	: 3200K-5600K
Battery	: NP-F550 / 750 / 960 lithium-ion
Weight	: 1.1Kg

Digitek Light Stand DLS-009FT

Digitek 9 Feet Light Stand are lightweight & stable option for indoor & outdoor Photographic Lighting. **Sturdy & Solid Lighting Tripod stands** with easy Flip Lock & Height adjustment with its 3 Sections structure. **1/4 inch mounting thread** and **Shock absorption Spring** for stable shoot. **Compatible with Ring Light, Flash Units, Light Lamps, Reflectors, Umbrellas etc**

LED Ring Light with Remote Control
DRL-18RT

Intensity Control

Color Temperature Adjustment

Rotation

Power ON/OFF & AC Input

USB Charging Point

LED Ring Light with Remote Control
DRL-18RT

Digitek LED Ring Light DRL-18RT with No Shadow apertures, is essentially a boon for Photo-Video shoots. Works on AC power. This Bi-color light source is oasis for amazing results. Ideal for Make-up artists & Fashion photographers, Video Shoot, You tube Videos etc. Perfect light to shoot interviews, food / Product shots, V-logs, Documentaries & much more. Can mount it to a grip head or light stand as per need. It has Stepless Adjustment for Color Temperature to maintain product tone or create fine subject details.

Specifications:

Input	: 110V/220 50HZ/60HZ
Output Power	: 60 Watt
Luminance	: 5400 LM
Color Temperature	: 2700K-6500K
Adjustment Range	: Remote Control Stepless Adjustment
No. of LED	: 480 Pcs
Dimension	: Internal Diameter 360mm, External Diameter 450mm
Weight	: 1.1Kg

LED Ring Light with Remote & 9 Feet Light Stand
DRL-18RT C 9

Intensity Control

Color Temperature Adjustment

Rotation

Power ON/OFF & AC Input

USB Charging Point

1/4 inch Mounting Thread

Easy Flip Lock

3 Sections

Shock Absorption Springs

9 Feet

LED Ring Light with Remote & 9 Feet Light Stand
DRL-18RT C 9

Digitek LED Ring Light DRL-18RT C9 Combo with No Shadow apertures, is essentially a boon for Photo-Video shoots. Works on AC power. This Bi-color light source is oasis for amazing results. Ideal for Make-up artists & Fashion photographers, Video Shoot, You tube Videos etc. Perfect light to shoot interviews, food / Product shots, V-logs, Documentaries & much more. Can mount it to a Grip Head or Light Stand as per need. Stepless Adjustment for Color Temperature to maintain product tone or create fine subject details.

Specifications:

Input	: 110V/220 50HZ/60HZ
Output Power	: 60 Watt
Luminance	: 5400 LM
Color Temperature	: 3200K-5600K
Adjustment Range	: Remote Control Stepless Adjustment
No. of LED	: 480 Pcs
Dimension	: Internal Diameter 360mm, External Diameter 450mm
Weight	: 1.1Kg

Digitek 9 Feet Light Stand are lightweight & stable option for indoor & outdoor Photographic Lighting. Its Sturdy & Solid Lighting Tripod stands with easy Flip Lock & Height adjustment with its 3 Sections structure. 1/4 inch mounting thread and Shock absorption Spring for stable shoot.

LED Ring Light with Remote & 6 Feet Light Stand
DRL-18RT C 6

Intensity Control

Color Temperature Adjustment

Rotation

Power ON/OFF & AC Input

USB Charging Point

1/4 inch Mounting Thread

Easy Flip Lock

3 Sections

Shock Absorption Springs

6 Feet

LED Ring Light with Remote & 6 Feet Light Stand
DRL-18RT C 6

Digitek LED Ring Light DRL-18RT C 6 with No Shadow apertures, is essentially a boon for Photo-Video shoots. Works on AC power. This Bi-color light source is oasis for amazing results. Ideal for Make-up artists & Fashion photographers, Video Shoot, You tube Videos etc. Perfect light to shoot interviews, food / Product shots, V-logs, Documentaries & much more. Can mount it to a grip head or light stand as per need. It has Stepless Adjustment for Color Temperature to maintain product tone or create fine subject details.

Specifications:

Input	: 110V/220 50HZ/60HZ
Output Power	: 60 Watt
Luminance	: 5400 LM
Color Temperature	: 3200K-5600K
Adjustment Range	: Remote Control Stepless Adjustment
No. of LED	: 480 Pcs
Dimension	: Internal Diameter 360mm, External Diameter 450mm
Weight	: 1.1Kg

Digitek 6 Feet Light Stand are lightweight & stable option for indoor & outdoor Photographic Lighting. Its Sturdy & Solid Lighting Tripod stands with easy Flip Lock & Height adjustment with its 3 Sections structure. 1/4 inch mounting thread and Shock absorption Spring for stable shoot.



Plug the USB Port into the Power Socket, turn ON/OFF the Power Button



Three Geared Temperature Control & ON/OFF Switch



Mini Tripod Stand included in Package



LED Ring Light with Dual Color Temperature

DRL-14

LED Ring Light DRL-14 with No Shadow apertures, is essentially a boon for Photo-Video shoots. This Bi-color Light source is oasis at places like market, beach, park or any outdoor for amazing results. Also ideal for Make-up artists & Fashion photographers. Perfect light to shoot interviews, Food / Product Shoots, V-logs, Documentaries & much more. Can mount it to a Grip Head or Light Stand as per need. Stepless Adjustment for Color Temperature to maintain product tone or create fine subject details.

Specifications:

Input	: DC 5V / 1A
Output Power	: 30 Watt
Luminance	: 2700 LM
Color Temperature	: 3200K-5600K
Adjustment Range	: Stepless Adjustment
Flash Index	: RA>97
Diameter	: Inner -230mm, Outer-310
Weight	: 0.45 Kg



Plug the USB Port into the Power Socket, turn ON/OFF the Power Button



Three Geared Temperature Control & ON/OFF Switch



Mini Tripod Stand included in Package



5 Feet



1/4 inch Mounting Thread



Easy Screw Lock



4 Sections



Easy & Quick Folding

LED Ring Light with Light Stand

DRL-14C

LED Ring Light DRL-14C with No Shadow apertures, is essentially a boon for Photo-Video shoots. This Bi-color Light source is oasis at places like market, beach, park or any outdoor for amazing results. Also ideal for Make-up artists & Fashion photographers. Perfect light to shoot interviews, Food / Product Shoots, V-logs, Documentaries & much more. Can mount it to a Grip Head or Light Stand as per need. Stepless Adjustment for Color Temperature to maintain product tone or create fine subject details.

Specifications:

Input	: DC 5V / 1A
Output Power	: 30 Watt
Luminance	: 2700 LM
Color Temperature	: 3200K-6500K
Diameter	: Inner -230mm, Outer-310
Weight	: 0.45 Kg

Digitek Lightweight Stand DLS-005 FT for Indoor & Outdoor Photographic Lighting. Sturdy & Solid Lighting Stand with Flip Lock & Height Adjustment with its 5 sections structure. 1/4 inch mounting thread and shock absorption spring for stable shoot



Plug the USB Port into the Power Socket & Turn ON/OFF Power Button



1/4" Screw Mount can be connected to the External Devices Such as Mobile Phone Clips



Loosen the Angle Tilt Knob & position in to the required angle then tighten the Angle Tilt Knob until it fixed



Loosen the Light Stand Mount locking knob & Fix the LED Ring Light onto the stud of Light Stand Fix LED Ring Light Properly



5 Feet



1/4 inch Mounting Thread



Easy Screw Lock



4 Sections



Easy & Quick Folding

LED Ring Light with Light Stand

DRL-12C

Digitek LED Ring Light DRL-12C with No Shadow apertures, is essentially a boon for Photo-Video shoots. This Bi-color Light Source is oasis at places like Market, Beach, Park or any outdoor for amazing results. Also ideal for Make-up Artists & Fashion Photographers. Perfect light to shoot Interviews, Food / Product shoots, V-logs, Documentaries & much more. Can mount it to a grip head or light stand as per need. It has Stepless Adjustment for Color Temperature to maintain product tone or create fine subject details.

Specifications:

Input	: DC 5V
Output Power	: 25 Watt
Luminance	: 2250 LM
Color Temperature	: 3200K-6500K
Adjustment Range	: 3 Geared Temperature Control & ON/Off Switch
Dimension	: External Diameter 279mm

Digitek Lightweight Stand DLS-005 FT for Indoor & Outdoor Photographic Lighting. Sturdy & Solid Lighting Stand with Flip Lock & Height Adjustment with its 5 sections structure. 1/4 inch mounting thread and shock absorption spring for stable shoot



professional

LED LIGHT WAND

One Light Multi-Applications

Perfect for object shooting, Portrait Shoot, Stage Party, Fashion Shoot, Wedding, Emergency, Dinner & more.

it's super light and can be used as a Handheld Unit or attached to a Stand or Tripod for flexible placement.



Handheld AC /DC RGB LED Light Wand DSL-25W RGB

Digitek DSL-25W RGB is a Lightweight & Easy Control: Easy Control Buttons provides the One Hand Control. Portable Handheld RGB Led Light Wand with Barn Door DSL-25W RGB Ideal for Make-up Artists & Fashion Photographers, Video Shoot, You tube Videos etc. Can mount it to a Grip Head or Light Stand as per need. Works Both on AC & DC Power input, Adapter included with Pack.

Specifications:

Power Adaptor	: DC 9V
Output Power	: 25 Watt
Luminance	: 3000 LM
Color Temperature	: 2700K-7500K+RGB
Color Rendering Index	: CRI->96+2, TLCI->96+2
LED Bulbs	: 204 LED's
Remote	: Infrared Control
Battery	: Li-ion Battery NP-F550(Not Included in Package)
Dimmer Intensity Range	: 10%-100%

With Built in 39 Special Effects

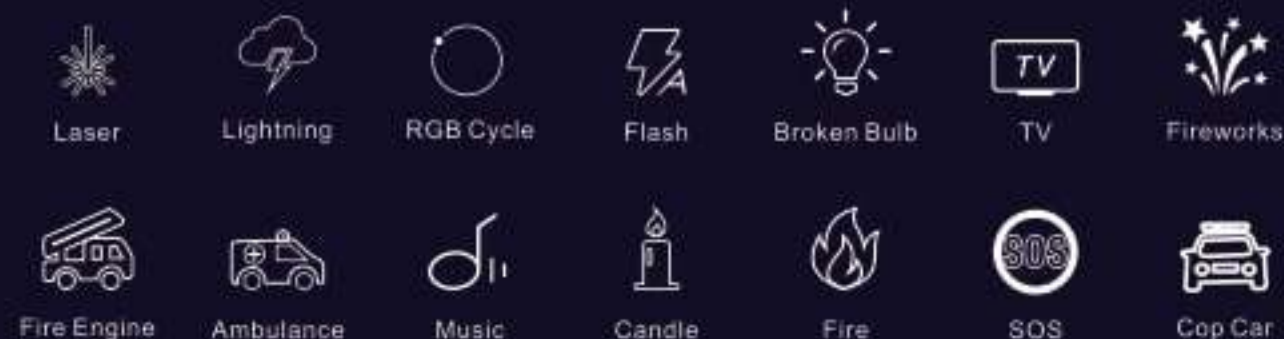



Fix it with built-in Magnet To fix it on metallic surface like Metal Trip, Window, Door etc.

LED Screen Monitor of Operating Color Temperature & Scenario Lighting modes are displayed

Easy Control Buttons provides the One-Hand Control

Type-C Charging Input Charge the device with Type-C 5V/2A Port

Universal Mounting Universal Thread on the base of handle allow Stand Mounting and Handle Fixing



With Built in 21 Mode of Dynamic Effects Presets



Create Effects Selective Scenario Lighting Option Provided to fit your needs

Easy Control Easy Control Buttons provides the One-Hand Control

LED Screen Monitor of Operating Color Temperature & Scenario Lighting modes are displayed on LED screen

Universal Mounting 1/4" Thread Thread for Stand Mounting

Extra Hot when Connection with Hot shoe provide more light



Create Effects Selective Scenario Lighting Option Provided to fit your needs

Easy Control Easy Control Buttons provides the One-Hand Control

LED Screen Monitor of Operating Color Temperature & Scenario Lighting modes are displayed on LED screen

Universal Mounting 1/4" Thread Thread for Stand Mounting

Extra Hot when Connection with Hot shoe provide more light with Hot shoe provided to connect Hotshoe lamps



Portable Handheld LED Light Wand

DSL-10W RGB

Digitek DSL-10W RGB is a lightweight & Portable LED Light Wand with No Shadow apertures, is essentially a boon for Photo-Video shoots. Works on Li-ion Batteries (not included). This light has an option of Bi-color light source with 7 Scenario effects. Ideal for Make-up artists & Fashion photographers, Video Shoot, You tube Videos etc. Can mount it to a grip head or light stand as per need.

Specifications:

Output Power	: 10 Watt
Input	: USB C Type 5V /2A
Luminance	: 1200 LM
Color Temperature	: 2500K-9900K RGB
LED Bulbs	: 72 Pcs White LED's + 72 Pcs Warm LED's + 36 Pcs RGB LED's +
Color Rendering index	: Ra>95
Mode	: CCT/HSV/Effect Mode
Light Source	: 0.2 Watt High Bright SMD
Battery	: Li-ion Battery NP-F550/750/970
Dimension	: 32x37x35mm
Mount Interface	: 2 x 1/4 inch screw hole

Portable Handheld LED Light Wand

DSL-20W

Digitek DSL-20W is a Lightweight & Portable LED Light Wand with No Shadow apertures, is essentially a boon for Photo-Video shoots. Works on Li-ion Batteries (not included). Bi-color Light source with 7 Scenario effects. Ideal for Make-up Artists & Fashion Photographers, Video Shoot, You tube Videos etc. Can mount it to a Grip-Head or Light Stand as per need.

Specifications:

Power Adaptor	: 8V 3A
Output Power	: 20 Watt
Luminance	: 2400 LM
Color Temperature	: 3000K-6000K
LED Bulbs	: 200 PCs
Remote	: Infrared Control
Battery	: Li-ion Battery NP-F550/750/970
Dimension	: 48x27x56 mm
Dimmer Intensity Range	: 10%-100%

Portable RGB LED Light Wand

DSL-20W RGB

Digitek DSL-20W is a Lightweight & Portable LED Light Wand with No Shadow apertures, is essentially a boon for Photo-Video shoots. Works on Li-ion Batteries (not included). Bi-color/RGB Light source with 7 Scenario effects. Ideal for Make-up Artists & Fashion Photographers, Video Shoot, You tube Videos etc. Can mount it to a Grip-Head or Light Stand as per need.

Specifications:

Power Adaptor	: 8V 3A
Output Power	: 20 Watt
Luminance	: 2400 LM
Color Temperature	: 3000K-6000K
LED Bulbs	: 99 Daylight LED's + 99 Tungsten LED's + 60RGB LED's
Remote	: Infrared Control
Battery	: Li-ion Battery NP-F550/750/970
Dimension	: 48x27x56 mm
Dimmer Intensity Range	: 10%-100%

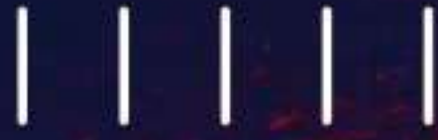

professional

RGB LED VIDEO LIGHT

One Light Multi-Applications

Perfect for object shooting, V-logs, Portrait Shoot, Stage Party, Fashion Shoot, Wedding, Emergency, Dinner, Documentaries & more.

it's supper light and can be used as a handheld unit or attached to a stand or tripod for flexible placement.



LCD Panel to Read Status

LED-D556 RGB

Professional RGB LED Video Light

Digitek professional LED Video Light LED-D556 RGB with a Unique design & feature for Photography style. Compact & lightweight & easy to carry. can concentrate & increase the lighting. its High end LED's gives much better experience while shoot indoor & outdoor with its **Bi-Color** & **RGB** Effects. it enriches your shooting environment, including Wedding, Functions, Party, Lightning, Paparazzi, Disco etc.

Specifications:

Input Power	: DC -24V 2A
Power (Max Output)	: 40 Watt
Color Temperature	: 3200-5600K+ RGB
Illumination	: 3600LM
Lamp Beads	: 360+196 RGB+
Cooling Mode	: Natural Ventilation
Beam Angle	: 120°C
Product Dimension	: 360 x 250 x 25mm

Beam Angle
120°

Output Power
40
Watt

Luminance
3600
LUX

Color Temperature
**3200K-
5600K+**
RGB



Built in Li-Polymer Battery
4000
mAh

Luminance
1200
LUX

Color Temperature
3200K-5600K

Effect & Preset
21
Scene & Effects



OLED Screen
Display of Brightness,
Color Temperature
& Battery Status

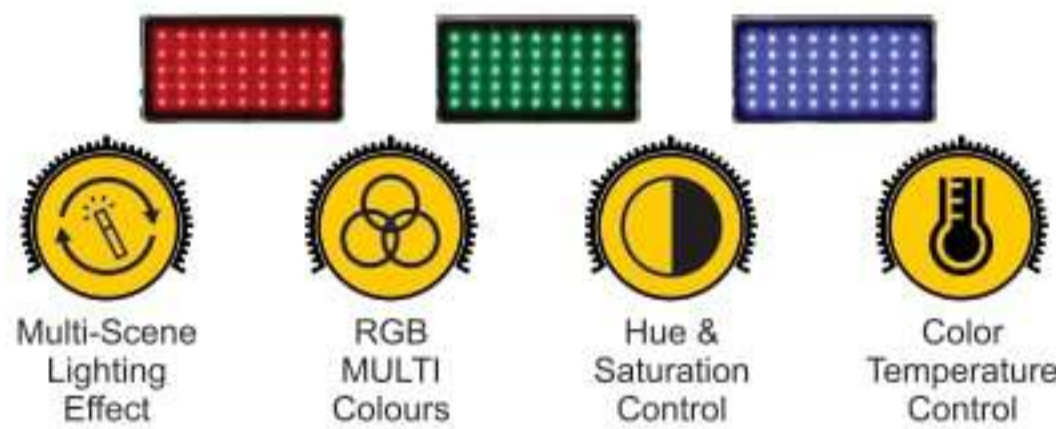

LED-D135 ML RGB

Professional RGB LED Video Light

Digitek Portable Professional RGB LED Video Light (LED-D135 ML RGB) is an amazing choice for Professional Photographer. Equipped with bundle of advanced features like Brightness & Color Temperature, Hue & Saturation Settings, 21 nos. of Scenario effects Preset etc. "RGB Light" for Wedding Shoots, Interviews, Portraits, Videos & Macro shots - with your phone or camera. Having 4000mAh Lithium inbuilt Battery with **USB Type-C** charging port.

Specifications:

Charging / Input Power	: 5V 2A USB - C
External Output Power	: 5V 2A USB
Color Temperature	: 2500K-9900K
Color Model	: 0-360° Full Color Control (HSI)
Brightness Control	: 1%-100%
Max Brightness / Illuminance	: 1200 Lux (@0.5m) (5600K)
Power (Max Output)	: 12W
Color Rendering Index	: 96+
Battery Capacity	: 3.7V 4000mAh
Net Weight & Size	: 200gms / 151*80*11.5mm

Built in Li-Polymer Battery
4000
mAh

Luminance
1200
LUX

Color Temperature
2500K-9900K



TFT Screen
Display of Brightness,
Color Temperature
& Battery Status

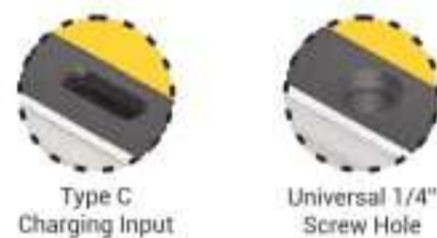

Metal Body Portable LED Video Light

LED-D180 ML

Digitek Portable Professional LED Video Light (LED-D180 ML) is an amazing choice for Professional Photographer. Equipped with bundle of advanced features like Brightness & Color Temperature, "Light" for Wedding Shoots, Interviews, Portraits, Videos & Macro shots - with your phone or camera. Having inbuilt **4000mAh** Lithium Battery with **USB Type-C** charging port.

Specifications:

Display Screen	: TFT Screen
Color Temperature	: 2500K-9900K (+350K)
Brightness Control	: 0-100%
Max Brightness / Luminance	: 1200 LUX / 0.5m (5600K)
Maximum Power	: 12W
Battery Capacity	: 3.7V/4000mAh
Charging Time	: Approx 3 Hours
CRI	: 96+
Charging Input Power	: 5V/2A Type C
Net Weight & Size	: 215.8 gms / 151*79.1*11.5 mm

Power
10W
Max

Color Temperature
2500K-9900K

Luminance
200LM
(100% 9900K)
180LM
(100% 2500K)



Portable Mini RGB LED Video Light

LED-D10W RGB

Digitek LED-D10W RGB Video, LED Camera Light 360° Full Color Portable Photography Lighting Dimmable Panel Lamp. Support Magnetic Attraction. Ideal for Make-up artists & Fashion photographers, Video Shoot, You tube Videos etc.

Specifications:

Display Screen	: White OLED
Power / Input USB-C	: 10W (MAX) / Charging Port 5V 2A
Battery Capacity	: 3.7V/2000mAh
Charging Time	: Approx 1 hour and 50 minutes
Battery Endurance	: Approx 120 minutes with 100% power
Quantity of LED	: 20pcs pure white LED + 20pcs warm white LED + 20pcs 5*5RGB LED
Luminous flux (Integrating sphere, cold machine test)	: CCT Mode : 200LM (100% 9900K), 180LM (100% 2500K) HSI Mode : H=100%, L=100% R 90LM G 215LM B 38LM
CCT Mode Color Temperature	: 2500K-9900K±350K
CCT Mode Color Rendering	: Ra≥96
CCT Dimming Method	: Power 1-100%
HSI Mode	: Hue 0-360°, Saturation 0-100, Brightness 1-100
Dimming Range	: 1-100%
Lighting Angle	: 120°
Scene Mode	: 7 categories, total 21 Type Lighting Effects
Working Mode	: CCT/HSI/FX scene mode

Output Power
37
Watt

Luminance
3400
LUX

Color Temperature
3200K-5600K

Power Source
F Series Li-ion Battery



NP-750 Li-ion Battery with Micro Charging interface (Included in the Pack)

Output Power
37
Watt

Luminance
3400
LUX

Color Temperature
3200K-5600K

Power Source
F Series Li-ion Battery



NP-750 Li-ion Battery with Micro Charging interface (Included in the Pack)

Output Power
32
Watt

Luminance
2900
LUX

Color Temperature
3200K-5600K

Power Source
F Series Li-ion Battery



NP-750 Li-ion Battery with Micro Charging interface (Included in the Pack)

LED-D520 B

Combo With Barn Door

LED-D520 B Combo, with a Unique design & feature for Photography Style. It's not only compact in size but also lightweight & easy to carry. LED-D520 B Combo can concentrate & increase the lighting. Its High End LED's gives much better experience while shoot indoor & outdoor. Its continuous light source eliminates the Red Eye Effects caused by camera's Flash.

Specifications:

Input Voltage	: DC-8.4V
Power (Max Output)	: 37W
Applicable Battery	: Sony NP-F Series Li-ion Batteries
Average Life Span	: 30,000 Hrs.
Lumens	: 3400 LM
Color Rendering Index	: 90%
Cooling Mode	: Natural Ventilation
Color Temperature	: 3200K-5600K
Beam Angle	: 120°
Net Weight & Size	: 273gms / 173*111.6*28mm

LED-D520 WB

Combo Without Barn Door

LED-D520 WB Combo, with a Unique design & feature for Photography Style. It's not only compact in size but also lightweight & easy to carry. LED-D520 WB Combo can concentrate & increase the lighting. Its High End LED's gives much better experience while shoot indoor & outdoor. Its continuous light source eliminates the Red Eye Effects caused by camera's Flash.

Specifications:

Input Voltage	: DC-8.4V
Power (Max Output)	: 37W
Applicable Battery	: Sony NP-F Series Li-ion Batteries
Average Life Span	: 30,000 Hrs.
Lumens	: 3400 LM
Color Rendering Index	: 90%
Cooling Mode	: Natural Ventilation
Color Temperature	: 3200K-5600K
Beam Angle	: 120°

LED-D416

Combo Without Barn Door

Unique design & feature for Photography Style. It's not only compact in size but also lightweight & easy to carry. Can concentrate & increase the lighting. High End LED's gives much better experience shoot / indoor Shoot. Its continuous light source eliminates the Red Eye Effects caused by camera's Flash.

Specifications:

Input Voltage	: DC-8.4V
Power (Max Output)	: 32W
Applicable Battery	: Sony NP-F Series Li-ion Batteries
Average Life Span	: 30,000 Hrs.
Lumens	: 2900 LM
Color Rendering Index	: 90%
Cooling Mode	: Natural Ventilation
Color Temperature	: 3200K-5600K
Beam Angle	: 120°



professional

CONTINUOUS LED VIDEO LIGHT

Unique Modern Mellifluous tool to design, cater the Photographers aesthetic idea suitable for all kinds of Small Production Photography / Power saving & Environment Protection. Long working life.

Made of High-Strength Aluminum Alloy and durable Engineering Plastic Outer Case. The mounting is also individual designed, which looks beautiful, fashionable in style.

Suitable for Meeting Rooms, Small Studio, News Studio, Advertising company, small productions and People's Photography.



Continuous LED Light DCL-100W DC

Features

Digitek Continuous AC/DC LED Photo/Video Light DCL-100W DC, a Unique Modern Meticulous design to cater to the Photographers aesthetic idea. Suitable for all kinds of Professional Photography / Power saving & Environment Protection. Long working life. Comes with a Yoke and 5/8" Receiver that is compatible with most Photographic Light stands. It has Special Effects that includes Paparazzi, Firework, Bad Bulb, Thunder Flash, TV and SOS, which is designed to enhance your work and save your time in creating complex lighting scenarios. New Green High-Tech production. Non- Deformation, Non- Breakage, can adjust brightness or darken as required. Suitable for Meeting Rooms, Small Studio, News Studio, Advertising company, small productions and People's Photography. Made of High-Strength Aluminum Alloy and durable Engineering Plastic Outer Case. The mounting is also individual designed, which looks beautiful, fashionable in style. It has latest strong Anti-jamming CPU, which makes the circuit /structure more simple & reasonable. Also controlling statistics stable and improves the consistency of the whole light. It is cooled by an inbuilt Quiet Controllable Fan to work longer time. Runs on AC 110-240V AC as well as DC power (NP-F960 x 2 Series Batteries - not included) both.

Specifications :

Output Power	: 100W
Luminance	: 9000LM
CRI	: 95
LED Quantity	: 1 Pc
Color Temperature	: 5600K ±200K
Compatible Battery	: NP-F960 X 2 (Not included in the Package)
Adjustable Range	: 10% - 100%
Remote Control	: 99 Channel 2.4G Infrared Remote Control
Remote Control Distance	: 30 Meters
Voltage	: AC100-240V 50/60Hz DC 19V-4.7A

Continuous LED Light DCL-150W DC

Features

Digitek Continuous AC/DC LED Photo/Video Light DCL-150W DC, a Unique Modern Meticulous design to cater to the Photographers aesthetic idea. Suitable for all kinds of Professional Photography / Power saving & Environment Protection. Long working life. Comes with a Yoke and 5/8" Receiver that is compatible with most Photographic Light stands. It has Special Effects that includes Paparazzi, Firework, Bad Bulb, Thunder Flash, TV and SOS, which is designed to enhance your work and save your time in creating complex lighting scenarios. New Green High-Tech production. Non- Deformation, Non-Breakage, can adjust brightness or darken as required. Suitable for Meeting Rooms, Small Studio, News Studio, Advertising company, small productions and People's Photography. Made of High-Strength Aluminum Alloy and durable Engineering Plastic Outer Case. The mounting is also individual designed, which looks beautiful, fashionable in style. It has latest strong Anti-jamming CPU, which makes the circuit /structure more simple & reasonable. Also controlling statistics stable and improves the consistency of the whole light. It is cooled by an inbuilt Quiet Controllable Fan to work longer time. Runs on AC 110-240V AC as well as DC power (Sony NP-F Series Batteries - not included) both.

Specifications :

Output Power	: 150W
Luminance	: 13500LM
CRI	: 95
LED Quantity	: 1 Pc
Color Temperature	: 5600K ±200K
Compatible Battery	: Sony V Lock Battery (Not included in the Package)
Adjustable Range	: 10% - 100%
Remote Control	: 99 Channel 2.4G Infrared Remote Control
Remote Control Distance	: 30 Meters
Voltage	: AC100-240V 50/60Hz DC 19V-4.7A



Also works with
2.4G Remote
(Not included in
Package)



COB LED LIGHT
High Power LED Bead

RUN ON AC/DC POWER
Available Battery Socket & DC Power Input

LCD DIGITAL DISPLAY
Easily Read the Real Brightness/Intensity Control & Volume



Also works with
2.4G Remote
(Not included in
Package)



COB LED LIGHT
High Power LED Bead

RUN ON AC/DC POWER
Available Battery Socket & DC Power Input

LCD DIGITAL DISPLAY
Easily Read the Real Brightness/Intensity Control & Volume



POWER OUTPUT
150
WATT
POWER OUTPUT

COLOR TEMP
5600K
...

LUMINOUS
13500
LM
FLUX



COB LED LIGHT
High Power
LED Bead



BOWENS MOUNTING
Compatible with
Bowens-Mount Accessories



LED DISPLAY
Easily read the
intensity Control

Continuous LED Light

DCL-150W

Features

Digitek Continuous LED Photo/Video Light DCL-150W, a Unique Modern Mellifluous tool to design, cater the Photographers aesthetic idea suitable for all kinds of Small Production Photography / Power saving & Environment Protection. Long working life. New Green High-Tech production. Non-Deformation, Non-Breakage, can adjust brightness or darken as required. Suitable for Meeting Rooms, Small Studio, News Studio, Advertising company, small productions and People's Photography. Made of High-Strength Aluminum Alloy and durable Engineering Plastic Outer Case. The mounting is also individual designed, which looks beautiful, fashionable in style.

It has latest strong Anti-jamming CPU, which makes the circuit /structure more simple & reasonable. Also controlling statistics stable and improves the consistency of the whole light. Designed over Heat Protection and High Power cooling fan, which is suitable for wide range voltage.

Specifications

Output Power	:	150W
Luminance	:	13500LM
CRI	:	95
LED Quantity	:	1 Pc
Color Temperature	:	5600K
Adjustable Range	:	10% - 100%
Remote Control	:	Infrared Remote Control
Remote Control Distance	:	10 Meter
Voltage	:	AC100-240V 50/60Hz



Also work with
2.4 G Remote
(Not included in Package)

POWER OUTPUT
150
WATT
POWER OUTPUT

COLOR TEMP
**3000K-
6500K**
...

LUMINOUS
13500
LM
FLUX



COB LED LIGHT
High Power
Led Bead



BOWENS MOUNTING
Compatible with
Bowens-Mount Accessories



LED Display
Easily read the
intensity Control

Continuous LED Light

DCL-150WBC

Features

Digitek Bi-Color continuous LED Light DCL-150 WBC, a Unique Modern Mellifluous tool to design, cater the Photographers aesthetic idea suitable for all kinds of small production Photography/Power saving & Environment Protection. Long working life. New Green High-Tech production. non-deformation, non-Breakage, can adjust brightness as required. suitable for meeting rooms, small studio, news studio, advertising company, small productions and people's photography. Made of High-Strength aluminum alloy and durable engineering plastic outer case. The mounting is also individual designed, which looks beautiful, fashionable in style. It has latest strong Anti-jamming CPU, which makes the circuit / structure more simple & reasonable. Also controlling statistics stable and improves the consistency of the whole light. Designed over Heat Protection and High Power cooling fan, which is suitable for wide range voltage.

Specifications

Output Power	:	150W
Luminance	:	13500LM
CRI	:	95
LED Quantity	:	1 Pc
Color Temperature	:	3000K-6500K+-200k
Adjustable Range	:	10% - 100%
Remote Control	:	2.4G Remote Control
Remote Control Distance	:	30 Meter
Voltage	:	AC100-240V 50/60Hz



Also work with
2.4 G Remote
(Not included in Package)



Continuous LED Light DCL-250WBC

Features

Digitek Bi-Color Continuous LED Light **DCL-250 WBC**, a Unique Modern Mellifluous tool to design, cater the Photographers aesthetic idea suitable for all kinds of small production Photography/Power saving & Environment Protection. Long working life. New Green High-Tech production. non-deformation, non-Breakage, can adjust brightness as required. suitable for meeting rooms, small studio, news studio, advertising company, small productions and people's photography. Made of High-Strength aluminum alloy and durable engineering plastic outer case. The mounting is also individual designed, which looks beautiful, fashionable in style. It has latest strong Anti-jamming CPU, which makes the circuit / structure more simple & reasonable. Also controlling statistics stable and improves the consistency of the whole light. Designed over Heat Protection and High Power cooling fan, which is suitable for wide range voltage.

Specifications

Output Power	: 250W
Luminance	: 22500LM
CRI	: 95
LED Quantity	: 1 Pc
Color Temperature	: 3000K-6500K ² 200k
Adjustable Range	: 10% - 100%
Remote Control	: 99 Channel 2.4G Remote Control
Remote Control Distance	: 30 Meter
Voltage	: AC100-240V 50/60Hz



COB LED LIGHT
High Power
Led Bead



BOWENS MOUNTING
Compatible with
Bowens-Mount Accessories



LED Display
Easily read the
intensity Control



Also work with
2.4 G Remote
(Not included in Package)



Continuous LED Light with 18cm Reflector DCL-250W

Features

- 1) Digitek Continuous LED Photo/Video Light **DCL-250W with 18cm Reflector**, a Unique Modern Mellifluous tool to design, cater the Photographers aesthetic idea suitable for all kinds of Small Production Photography / Power saving & Environment Protection. Long working life.
- 2) New Green High-Tech production. Non- Deformation, Non- Breakage, can adjust brightness or darken as required. Suitable for Meeting Rooms, Small Studio, News Studio, Advertising company, small productions and People's Photography.
- 3) Made of High-Strength Aluminum Alloy and durable Engineering Plastic Outer Case. The mounting is also individual designed, which looks beautiful, fashionable in style.
- 3) It has latest strong Anti-Jamming CPU, which makes the circuit /structure more simple & reasonable. Also controlling statistics stable and improves the consistency of the whole light.
- 4) Designed over Heat Protection and High Power cooling fan, which is suitable for wide range voltage.

Specifications

Output Power	: 250W
Luminance	: 22500LM
CRI	: ≥95
LED Quantity	: 1 Pc
Color Temperature	: 5600K+ 200K
Adjustable Range	: 10% - 100%
Remote Control	: 99 Channel 2.4G Remote Control
Remote Control Distance	: >60 Meter
Voltage	: AC100-240V 50/60Hz

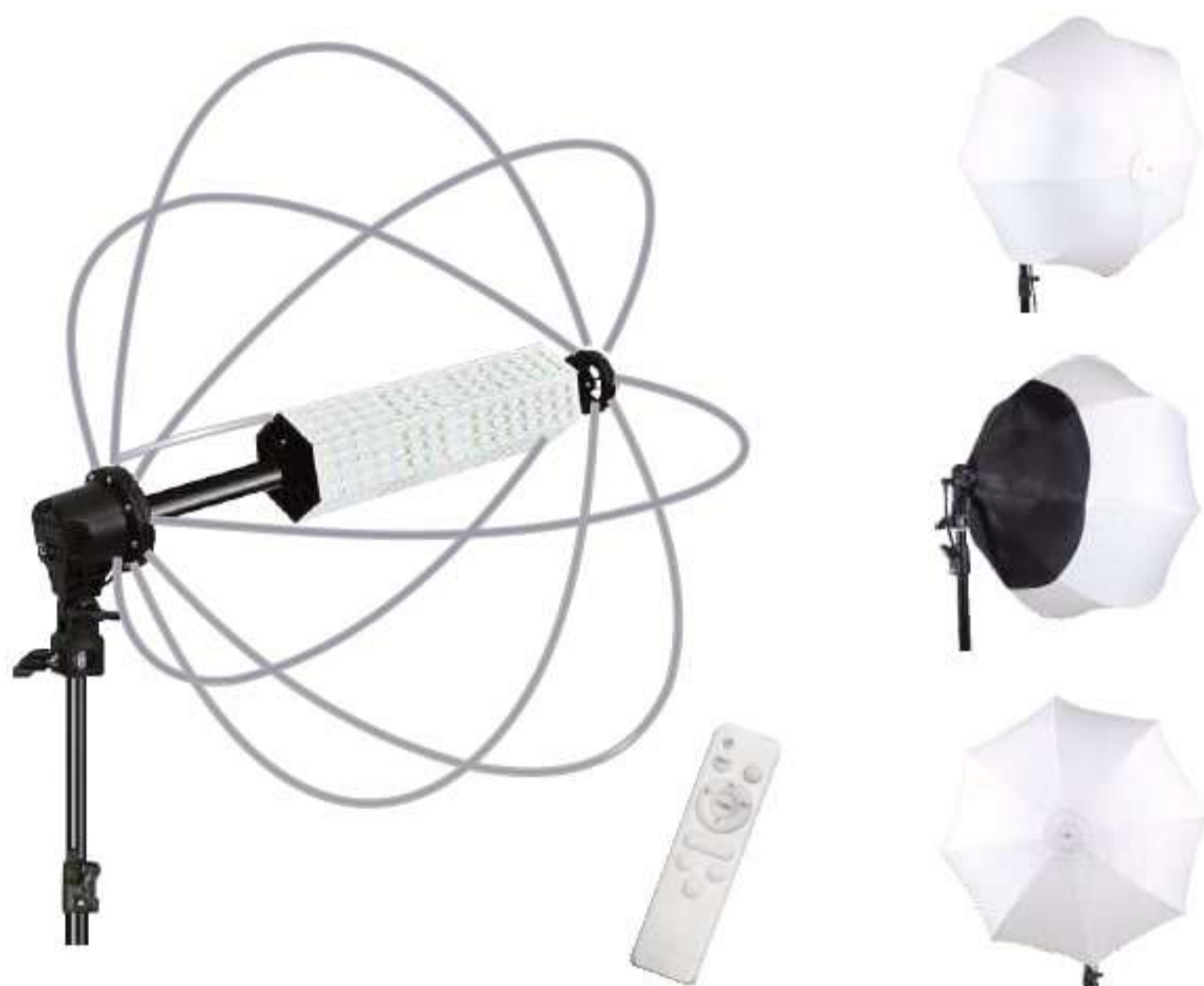

150w
Power Output

Luminous Flux
13500
LM

Colour Temperature
3000K-6500K
±200K

Continuous LED Light with Lantern Softbox

DCL-150 WB

Feature :

- 1) Digitek LED Photo/Video Light DCL-150 WB, a Unique Modern Mellifluous tool to design, cater the Photographers aesthetic idea suitable for all kinds of Small Production Photography / Power saving & Environment Protection. Long working life.
- 2) New Green High-Tech production. Non- Deformation, Non- Breakage, can adjust brightness or darken as required. Suitable for Meeting Rooms, Small Studio, News Studio, Advertising company, Small Productions and People's Photography.
- 3) Made of High-Strength Aluminum Alloy and durable Engineering Plastic Outer Case. The mounting is also individual designed, which looks beautiful, fashionable in style.
- 4) It has 360 Pcs White, 360 Pcs Yellow LED's in DCL-150 WB, 150W Output.

Specifications:

Output Power	: 150W
Luminous Flux	: 13500 LM
CRI	: 96+
LED Quantity (Pcs)	: White - 360 Yellow - 360
Remote Control	: Infrared Remote Control
Remote Control Distance	: >30M
Color Temperatures	: 3000K-6500K ±200K
Voltage	: AC100-240V 50/60Hz



150w
Power Output

Luminous Flux
13500
LM

Colour Temperature
3000K-6500K
±200K Plus RGB

Continuous LED Light with Lantern Softbox

DCL-150 WB RGB

Feature :

- 1) Digitek LED Photo/Video Light DCL-150 WB RGB, a Unique Modern Mellifluous tool to design, cater the Photographers aesthetic idea suitable for all kinds of Small Production Photography / Power saving & Environment Protection. Long working life.
- 2) New Green High-Tech production. Non- Deformation, Non- Breakage, can adjust brightness or darken as required. Suitable for Meeting Rooms, Small Studio, News Studio, Advertising company, Small Productions and People's Photography.
- 3) Made of High-Strength Aluminum Alloy and durable Engineering Plastic Outer Case. The mounting is also individual designed, which looks beautiful, fashionable in style.
- 4) It has 360 Pcs White, 360 Pcs Yellow 180 Pcs LED's in DCL-150WB RGB with 150W Output.

Specifications:

Output Power	: 150W
Luminous Flux	: 13500 LM
CRI	: 96+
LED Quantity (Pcs)	: White - 360 Yellow - 360 RGB- 180
Remote Control	: Infrared Remote Control
Remote Control Distance	: >30M
Color Temperatures	: 3000K-6500K ±200K Plus RGB
Voltage	: AC100-240V 50/60Hz

Widely
Compatible

- Small Studio
- News Studio
- Small Productions
- Advertising Company
- Wedding Photography



TTL/MANUAL ELECTRONIC FLASH SPEEDLITE & ACCESSORIES

Range of TTL/Manual Models with High Sync Speed & Accessories for Effective Solution for the Lighting Effects

- ✓ **Excellent Performance**
- ✓ **High Quality**

When it comes to the perfect Portable Lighting, Range of Electronic Flash Speedlite are the right solution for Ambitious or Professional Photographers. Electronic Flash Speedlite has a much larger, more powerful Flash Tube than your Pop-up Flash to spread light over a wider area & cover a greater distance, without to crank up your camera's ISO setting or Aperture. Useful when you're shooting with Wide Angle, Telephoto, or Zoom Lenses, And also reduces Red-eye Effect Which is caused by the light from flash. Available in TTL& Manual Model as per your needs.





DRM-009 Transmitter
for Electronic Flash Speedlite DFL-088



Expperience
GREAT CONTROLS

Flash Speedlite

DFL-088

with 2.4G inbuilt Receiver

Flash Speedlite DFL-088 is with 2.4G inbuilt Receiver to use with Trigger by which you can control the flash function even from 30 meters distance. Runs on 4 x Alkaline / Ni-MH Batteries, More Mobility, Easy to pack & carry in your Camera Bag. Photograph like Wedding, Event, Sports Event etc. Elevates your imagery in Different Lighting Conditions with Wireless Triggering Function.

Specifications:

Guide No.	: 40 ISO 100
Flash Duration	: 1/200~1/20000s
Vertical Rotation Angle	: 0~90 Degrees
Horizontal Rotation Angle	: 0~270 Degrees
Power	: 4 x AA size (Alkaline or Ni-MH Batteries)
Lighting Time	: 100 -1500 times (AA Alkaline Battery used)
Recycle Time	: Approx. 0.1-5s (AA Alkaline Batteries used)
Light Qty. Output Control	: with 1/8 stop increment
Color Temperature	: 5600K+200K
Flash Mode	: Manual, S1, S2
Dimensions	: 190*75*55mm
Net Weight	: 315g
Built-in- Receiver	: 2.4G Inbuilt Receiver

2.4G Transmitter

DRM-009

Digitek 2.4G Triggering Solution DRM-009 Transmitter is most suitable triggering solution for Digitek Electronic Flash Speedlite DFL-088.

Specifications:

Radio Frequency	: 2.4G
Wireless Connectivity	: 120 Meter
Flash Sync Speedup up to	: 1/320 Seconds





professional
SOFTBOX

With Diffuser Sheet
& Silver Lining

Available in
Different Size
& Mount





Beauty Dish Soft Box with Bowen Mount
DBDS-65 / 85 / 105

Digitek 65cm Beauty Dish Softbox DBDS-65 is High Quality, Collapsible, Transportable, Lightweight Bowen Mount Beauty Dish that you can take anywhere.

Features

- Quick and Easy system for safe and sure setup.
- Super-efficient Large Beauty Dish design.
- Great for travel, location, and studio.
- Soft Beauty Light for Fashion and Portrait Photography.
- All of the benefits of a Metal Beauty Dish without the worry of damage
- Reversible Deflector Element assures no center Hot Spot
- Includes Translucent Diffusers for a broader light spread
- Eggcrate grids for extra beam control and spill kill
- Speed Ring adapters for favorite flash reflector mounts.

AVAILABLE IN 85CM & 105CM SIZES
IN WHITE & SILVER VARIANT.



Eggcrate Grids for Extra Beam Control & Spill. Make Huge Difference in your Photography

Its Reflective Silver Interior to Render a Punchy High Contrast & Crispy Light.

White Interior Creates soft, Clean Pattern of Light straight toward your subject.

Nylon Fabric Diffusers soften your Light, perfect for beauty & fashion portraits.

Deep Parabolic Mouth design makes the Lighting Effect Uniform, Rich in Levels & Soft



S2 Type 55cm Octagon Soft Box Kit
DSBH-55/65/90/120 S2

- Provides classic soft but crisp light, for Portrait and Event Photography; Ideal for shooting portraits or event such as Weddings Promotions or Corporate Events on location etc.
- S-2 type Bracket Mount DESIGN: Allow flexible use with most Flash Speedlites and equipments.
- High Reflective; Made of collapsible Nylon Cover and proved to be High Reflective; With silver particle inner Baffle and 2 white Diffuser, help your photography by softening the flash light and casting even lighting
- QUICK OPENING AND FOLDING : Special design makes it quite easy to open or fold up, can be assembled or disassembled in a minute.
- CONVENIENCE : Light weight, foldable , and comes with a carrying case, convenient for storage or transportation.
- **Compatible with** Round & Rectangular Flash Speedlight.



Bowen Mount 65cm Octagon Soft Box Kit
DSB-65/90/120 BOWENS S2

- Provides classic soft but crisp light, for portrait and event photography;
- Bowen Mount DESIGN: Allow flexible use with most flash Speedlites and strobe lights & other equipments.
- HIGH REFLECTIVE: Made of collapsible nylon cover and lightweight Durable plastics handle grip and proved to be high reflective; With silver particle inner baffle and 2 white diffuser, help your photography by softening the flash light and casting even lighting
- QUICK OPENING AND FOLDING: Special design makes it quite easy to open or fold up, can be assembled or disassembled in a minute
- CONVENIENCE: Light weight, foldable, and comes with a carrying case, convenient for storage or transportation
- **Compatible with** Round & Rectangular Flash Speedlight.



Octogan Soft Box
DSB-080

Digitek Softbox are used heavily in Portrait Photography and many other type of Commercial Photography. DSB-080 Soft Box adopting the umbrella type deployment method. Equipped with a slit for passing the light stand at the bottom. For Speedlights of a style where the strobe fits inside The front diffuser is installed in Velcro. The reflective surface is silver. Its an effective and lightweight tool for reducing Light Intensity without sacrificing Softness of Light. Eliminates Hot Spot and evenly distributes the light as well.



5 in 1 Collapsible Reflector
DRB-5 IN 1

1. This is a 5-in-1 Collapsible Reflector Disc 47" /120cm
2. Comes in Silver, Gold, Black, White and Translucent.
3. Silver - for contrast & increase highlights,
 Gold - achieve Warm Glowing Skin tones,
 Black - Block out Unwanted Light
5. Package included : 1 x 107cm 42" 5-in-1 Light Multi Collapsible Disc Reflector, 1x Black Color Round Portable Carrying Bag



FLASH BOT GRIP (with Magnet)

Professional Flash Bot newly introduced the harnesses with the power of magnetism to a quicker, easier and stronger attachment method for Speedlite Flash modifiers. Say goodbye to velcro, sticky adhesives and bulky straps forever.



SPHERE

Soft Light, every time. Omni-Directional Flash Diffuser which gives you efficient diffusion. Inbuilt Gel Slot which allows you to change color of Flash to give awesome effects. Also increases the size of your light-emitting surface by over 250% for a softer glow over a bigger area.



BOUNCE

It's white silicone texture diffuses light without significantly decreasing output like other available modifiers. Bounce is a modifier that has been stripped down to its simplest, most functional form. Designed carefully to be both, beautiful and calculated, to deliver the softest light with the highest output.



GEL MOUNT

Softer light, every time. Professional Flash Bot comes with the ultimate Polycarbonate for Hat-Shoe Flashes. Lets experience improved Magnetic function to fix it for your use. Professional Flash Bot let's you swap out Polycarbonate Gels quickly and easily.



HIGH QUALITY SILICON GRID

One Grid to Rule Them All. Focuses your light into a precision 40 degree beam pattern with minimal spill. Made of Silicone Rubber, the Grid's carefully optimized beam pattern provides even light coverage, helps photographers to take cleaner and more consistent photographs.



CREATIVE POLYCARBONATE GELS

Professional Flash Bot Creative Gels set gives you the freedom to add awesome color addition to your image. Insert single choice or more than one from polycarbonate gels into the integrated slots in modifiers for an infinite number of creative lighting effects. Available Gel Colors are Cyan, Rose, Coral, Amber, Aquo, Pink, Lavender & Lime.



FLASHBOT DFB-001 / DFB-002

BE READY TO SHOOT
ANYWHERE





Professional Speedlight Flash Bot & Modifier Kit
DFB-001

Professional Speedlight Flash Bot & Modifier Kit, An absolute must for any photographer. This product will change the way you shoot and open up an amazing workflow for quickly adding or removing modifiers to any speedlite. Universal fit: Not just compatible with all types of flash guns, but also comes with universal fit with high magnet power & Instant Attachment.

Strong and Sleek Modular Design: Filters constructed of durable hard plastic. Ideal for: Weddings, pre weddings and outdoor shoot. Now be ready to shoot anywhere.
Click like a professional: Accessories yourself with Digitek Flash Bot-Professional flash accessories that are easy to install and adjust. Now control or diffuse light like a boss with our most popular modifiers and gels. Best start for the beginners.



Professional Speedlight Flash Bot & Modifier Kit
DFB-002

Professional Speedlight Flash Bot & Modifier Kit, An absolute must for any photographer. This product will change the way you shoot and open up an amazing workflow for quickly adding or removing modifiers to any speedlite. Universal fit: Not just compatible with all types of flash guns, but also comes with universal fit with high magnet power & Instant Attachment.

Strong and Sleek Modular Design: Filters constructed of durable hard plastic. Ideal for: Weddings, pre weddings and outdoor shoot. Now be ready to shoot anywhere.
Click like a professional: Accessories yourself with Digitek Flash Bot-Professional flash accessories that are easy to install and adjust. Now control or diffuse light like a boss with our most popular modifiers and gels. Best start for the beginners.



Professional Flashbot Grip with Magnet
DFBG-001

Professional Flash Bot Grip with Magnet, newly introduced the harnesses with the power of magnetism to a quicker, easier and stronger attachment method for Speedlite Flash modifiers. Say goodbye to velcro, sticky adhesives and bulky straps forever.

Specifications:

Material	: Elasticity Silicon Rubber
Mounting	: Grip with Magnet
Size	: 12 x 8 x 7 Cm
Weight	: 130gms
Power	: 4 x AA size (Alkaline or Ni-MH Batteries)
Fits	: Universal fit with most of Speedlite

UNIVERSAL FIT WITH HIGH MAGNET POWER



Creative Polycarbonate Gel & Wallet
DFCW-001

Professional Flash Bot Creative Gels set gives you the freedom to add awesome color addition to your image. Insert single choice or more than one from polycarbonate gels into the integrated slots in modifiers for an infinite number of creative lighting effects. Comes with Stylish and Compact Wallet to keep Gels without getting scratched or scattered & Safe.

Available Gel Colors are -
CYAN * ROSE * CORAL * AMBER * AQUA * PINK * LAVENDER * LIME



Flash Bot for Round Flash Head
DFB-003

A comprehensive collection of Light Modifiers for the Round Head Flashes . contains magnetically-attached modifiers that maximize the capabilities of the head. The kit contains a Snoot, Four-way Barndoors, and a Honeycomb Grid to narrow the light's beam and selectively light your subject. Conversely, a near-180-degree Dome, a Wide Lens, and a Bounce card with a frame are provided to expand the beam. Finally, a filter set with three amber CT filters and one green Fluorescent Filter are also included.

Accessories Attach Magnetically

- 1 x Diffuser Dome
- 3 x Warming Filters, 1 x Filter Holder
- 1 x Green Filter, 1 x Honeycomb Grid



Adaptor for Round Head Speedlite Accessories
DSR-001

Round Head Accessories Adaptor, a speedlite attachment that lets you mount the DFB-003 Round Magnetic Modifiers on traditionally shaped flashes. The Digitek DSR-001 adaptor slides onto Rectangular Flash Heads to provide a Round Magnetic Mounting point. Gridded Rubber Mats on the inside surface of the adaptor provide Scratch-Free Grip, and a screw on top helps tighten the adaptor around flashes of different sizes.



Mount Adaptor for Godox : Applicable to ML 30, ML 30Bi, ML 60, ML60Bi, AD 300PRO, AD 400PRO Lights etc.

Round Head Adaptor : Applicable to Round Head Flash like V1 Series AD100PRO / AD200PRO etc.

Rectangle to Round Head Adaptor : Applicable to most Rectangular Head Flash like DFL-088, DFL-055 etc.



Professional Collapsible Diffusion Dome Kit
DFB-004
 With Silicone Rubber

Digitek Collapsible Diffusion Dome Kit is Ideal for illuminating Small Spaces and Rooms, this Diffusion Dome expands the Light's Beam spread for 360° or collapses the back to diffuse at 180° or Collapsing the front to create a Soft quality of Light for more dimensionality, allowing you to take advantage of Variable Light Effects. Made from Silicone Rubber, which makes it Soft, Flexible & easily Squeezed into small spaces. Perfect for Still & Video Photo shoots like Weddings or Events, or for people who just want a small Discreet Modifier for their Light.



Mount Adaptor for Godox : Applicable to ML 30, ML 30Bi, ML 60, ML60Bi, AD 300PRO, AD 400PRO Lights etc.

Round Head Adaptor : Applicable to Round Head Flash like V1 Series AD100PRO / AD200PRO etc.

Rectangle to Round Head Adaptor : Applicable to most Rectangular Head Flash like DFL-088, DFL-055 etc.



Professional Soft Tent Diffusion Kit
DFB-005
 With Silicone Rubber

With Digitek Soft Tent Diffusion Kit, you can meet more precise Soft Light needs, to obtain a Soft & Proportional lighting experience.
Variable Light Effect : With Digitek Soft Tent Diffusion Kit you get even Panel Light with changeable softness, at cost of just one Modifier. Take advantage of variable Light Effects for all your needs.
Lightweight & Flexible in shape, easily to be squeezed as small as possible.
Includes 3 Adapters- Mount adapter for Godox, Roundhead adapter for Roundhead Flash Speedlites & Rectangle to Round Head adapter for all Rectangular Head Speedlite Flashes to use this Soft Tent Diffuser.





S2 Type Metal Speedlite Bracket DFSB-005

Compatible With Round Head & Normal Speedlite, Outdoor Flashes & Bowens Mount Accessories like Softbox, Reflector, Snoot, Photo Umbrella, Barndoor Kit

Specifications :

1. Compact structure : Updated based on original S-2 Type Bracket adjustable to fit most Speedlites - Regular/ Round Head/ Multi Flashes / Outdoor Flashes by removing 2 Blocks-included with.
2. Mounting Method : Speedlite body is hold and fixed by a big mount which provides a stable & secure support.
3. Installation : No Pre-assembly & post-disassembly. Do not require velcro, no pressure on Hotshoe.
4. Functions : Bowens-mount, Speed Ring, Umbrella input, Direction - adjustable handle, Mount Horizontally & Vertically by Wrapping Speedlite Body.
5. Compatible with : It can add most Studio Flash Accessories of Bowens Mount - Soft Box, Reflector, Beauty Dish etc.



Multipurpose S2 Type Speedlite Bracket DFSB-004

Compatible With Round Head, Normal Speedlite & Bowens Mount Accessories like Softbox, Reflector, Snoot, Photo Umbrella, Barndoor Kit etc.

Specifications :

1. Compact structure : Compressed & Flat Structure takes up little space.
2. Mounting Method : Speedlite body is hold and fixed by a big mount which provides a stable & secure support.
3. Installation : No Pre-assembly & post-disassembly. Do not require velcro, no pressure on Hotshoe.
4. Functions : With Bowens-mount, Speed Ring, Umbrella input, Direction - adjustable handle, Mount Horizontally & Vertically by Wrapping Speedlite Body.
5. Mount size is adjustable to fit most models of Speedlite available
6. It can add most Studio Flash Accessories of Bowens Mount - Soft Box, Reflector, Beauty Dish etc.



Multipurpose S Type Speedlite Bracket DFSB-003

Compact & Fast Structure takes little space Hold & Fixed by a big mount which provides stable & Secure support. Easy Installation - No Pre-assembly & post-disassembly. Do not require velcro, no pressure on Hotshoe. With Elinchrome-mount Speed Ring & Umbrella Input . Adjustable Handle Can mount Speedlite Body Horizontally Vertically. Mount size is adjustable to fit most models of Speedlite available in market.

Specifications:

Mount	: Elinchrome
Rotation	: 180°
Compatible	: Umbrella, Snoot, Reflector & Beauty Dish
Weight	: 410 gms
Dimension	: (L x W x H) Approx . 15 x 5.5 x 22 cm



Heavy Duty Metal Umbrella Clamp DMUC-001 With Hotshoe Mount

1. Compact & Light Weight Designed Umbrella Clamp, can also be used as a Speedlite Holder.
2. Fits on the top of most standard Studio Light Stands.
3. With Hotshoe Mount, you can mount a Hotshoe Flash / LED Video Light / Slave Sensor / Receiver.
4. Includes Umbrella Holder at the base of mount, able to adjust the Umbrella & Flash at different angles.
5. Tough, Durable, Compact, Light weight Aluminium Metal Clamp.



Durable



Made in India

Professional Photography Bag

DCB-001

With Rain Cover

- Carry all your expensive photography essentials safely
- Customisable Padded Divider to organize your Accessory
- Compatible with all top DSLR\SLR models & Photography Equipment
- Comfortably wherever you go. Exclusive Space for the Tripod /Monopod
- Additional Rain Cover for Bag Don't let the rain stop your journey



Additional Rain Cover for Valuable Safety



Durable



Made in India

Professional Photography Bag

DCB-002

With Laptop Compartment & Rain Cover

- Always protected - well-padded camera insert and dividers
- Comfortable carrying - well-padded back and harness
- Compact and lightweight **Camera Backpack with Laptop Compartment**
- offers hands-free transport of your photography gear
- 100% MADE IN INDIA : This Product is Made-in India with high-quality
- water resistant nylon and polyester; durable metal zippers; this bag lets
- you carry your expensive equipment safely in all weathers
- Well organized dedicated pockets for all essentials



Additional Rain Cover for Valuable Safety



Durable



Made in India





Digitek Porta Light with 14 Feet Light Stand

PORTA KIT 14FT

for Still / Video Photography setup

Digitek Porta Light Kit DPL-003 14FT is a Combo of 2 Nos. Porta Light DPL-003, 2x Umbrella & 2x14 Feet Light Stand DLS-014FT with a Carry Bag. It's a Cost Effective complete & Compact kit for Still & Video Shoots for High Brightness & Constant Lighting. Ideal for Indoor & Outdoor Shoots.

BOX CONTENTS:

- 2 x Porta Light DPL-003
- 2 x Light Stand DLS-014FT
- 2 x AC Power Cord 5m length,
- 2 x Umbrella,
- 1 x Kit Carry Bag



1000W | 3600K | 240V



Digitek Porta Light Kit with 9 Feet Light Stand

PORTA KIT 9FT

for Still / Video Photography setup

A Combo of 2Pcs of Porta Light DPL-003, White Studio Umbrella & 9 Feet Light Stand DLS-009FT with a Carry Bag. It's a Cost Effective complete & Compact kit for Still & Video Shoots for High Brightness & Constant Lighting. Ideal for Indoor & Outdoor Shoots.

BOX CONTENTS:

- 2 Porta Light DPL-003
- 2 Light Stand DLS-009FT
- 2 AC Power Cord 5m length,
- 2 Umbrella,
- 1 Kit Carry Bag



1000W | 3600K | 240V



Porta Halogen Video Light

DPL-003

for Still / Video Photography setup

Digitek Porta Light DPL-003 is a Video Halogen Light for Still & Videography Studio Setup. Cost Effective for High Brightness & Constant Lighting for Indoor & Outdoor Shoots.

Features :

Simple & quick installation: It is much easier frustration-free, simple & quick installable photo equipment. Fit for light stand mounting & umbrella mounting; tilt head for easy operation; wire stoppers allow keeping panels open in the position.

Light up Magical Moments: From expensive Ballroom weddings to Backyard weddings, no matter what the venue is this lighting accessory can add spark to any important moment.

Strong and Robust metal body: High grade metal construction makes it sturdy & durable.



1000W | 3600K | 240V



LIGHT STAND KIT 14 FTK

Pair of Heavy-Duty Light Stands

Digitek DLS-014FTK Pair of Lightweight & Portable 14 Feet Aluminum Alloy Light Stand for Photography & Video Shooting, Ring Light, Reflector, Flash Units, Light Lamps, Diffuser, Portrait, Softbox, Studio Lighting and one Carry Bag for easy handling.

Specifications:

Maximum Height	: 14 Feet Approx
Sections	: 3 (Three)
Folded Height	: 3.2 Feet (38.5 Inch)
Load Capacity	: 15 Kg (Approx)



LIGHT STAND KIT 9 FTK

Pair of Heavy-Duty Light Stands

Digitek DLS-009FTK Pair of Lightweight & Portable 9 Feet Aluminum Alloy Light Stand for Photography & Video Shooting, Ring Light, Reflector, Flash Units, Light Lamps, Diffuser, Portrait, Softbox, Studio Lighting and one Carry Bag for easy handling.

Specifications:

Maximum Height	: 9 feet (274 cm approx.)
Sections	: 3 (Three)
Folded Height	: 3.2 Feet (38.5 Inch)
Load Capacity	: 10 Kgs
Product Weight	: 4 Kgs

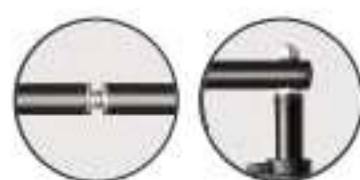

SOLID INTERLOCKING SYSTEM

DBSK-009FT

Studio Background Stand

Digitek Studio Backdrop Stand Kit **DBSK-009FT** Suitable for holding Photography & Videography Backdrops, Wedding Backdrop, Studio shoots, Selfie Booth Backdrop, Video Call Background, Projector Background, Online Video Shoots, and many more. Lightweight and Sturdy, Spring Loading for Shock absorption, Non-Slip locks. Easy to Assemble and Fits in to bag.

Specifications:

Maximum Height 9 feet(apx.)	: 9 Feet Approx.
Folded Height	: 3.2 Feet (38.5 Inch)
Aluminum bar 9 feet(apx.)	: 9 Feet
Weight	: 5500g

**For Professional & Enthusiastic Photographers
Suitable for Indoor & Outdoor Photo Shoots.**

Aluminium Cross Bar 3 feet Each.



Weight
2 Kgs



Maximum Height
14 Feet



Maximum Load
upto 12 kgs

14 Feet

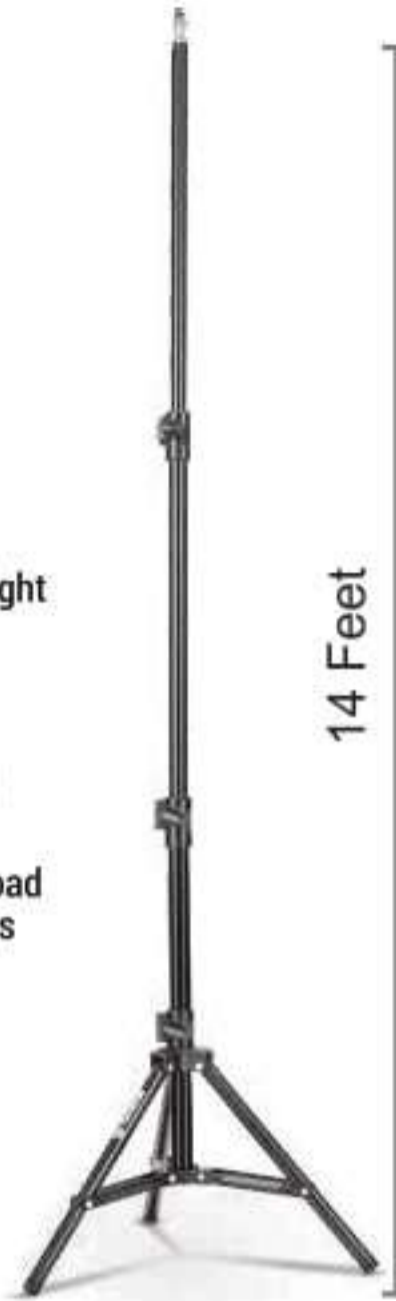

Photographic Light Stand

DLS-014 FT

for Still / Video Photography setup

1. Heavy Duty & Lightweight : **14 Feet Light Stand DLS-014FT** strong enough to hold most equipment yet Compact & Light weight. Can Carry effortlessly from one spot to another locations easily. Offers a collapsible design everything folds in a short, compact size.
2. Jerk Proof : Comes with shock absorption springs mechanism that protects equipment and fingers from damage & requires less efforts to assemble & disassemble. It's all 3 sections are secured with flip locks for better hold and slip free experience.
3. Crafted for All - Beginners & Professional : Capture professional Quality photographs under perfect light .Anyone can use this equipment. Compatible with Studio Lights, Flash Units, Ring Lights, LED Video Lights, LED Panels Reflectors, Umbrellas, Light lamps, Projectors and others.
5. Handy & Reliable : Discover endless lighting possibilities. Helps you target the light to your subject at any angle. Perfect for Indoor / Outdoor shooting.



1/4 inch
Mounting Thread



Easy Flip Lock



3 Sections



Shock Absorption
Springs



Weight
2 Kgs



Maximum Height
9 Feet



Maximum Load
upto 8 kgs

9 Feet

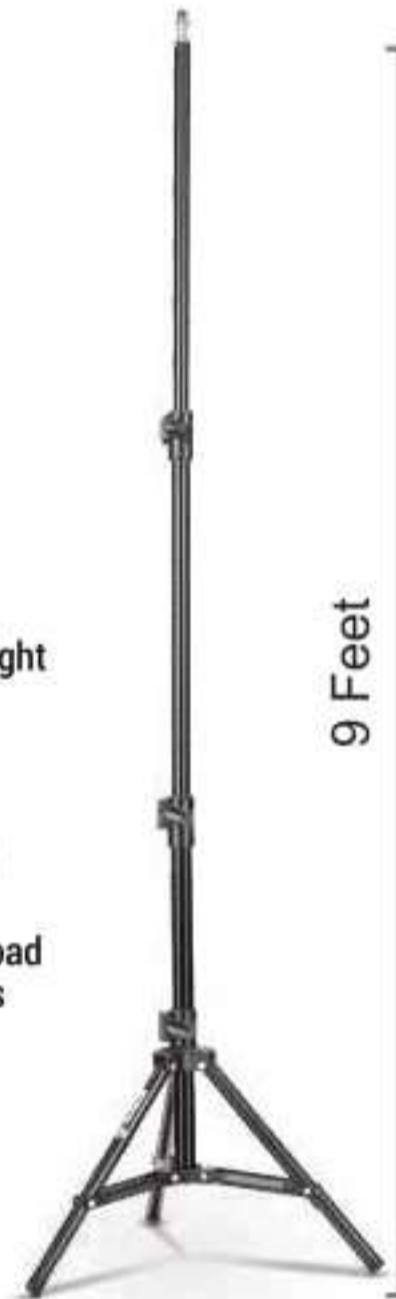

Photographic Light Stand

DLS-009 FT

for Still / Video Photography setup

1. Heavy Duty & Lightweight : **9 Feet Light Stand DLS-009FT** is strong enough to hold most equipment yet Compact & Light weight. Can Carry effortlessly from one spot to another locations easily. Offers a collapsible design everything folds in a short, compact size.
2. Jerk Proof : Comes with shock absorption springs mechanism that protects equipment and fingers from damage & requires less efforts to assemble & disassemble. It's all 3 sections are secured with flip locks for better hold and slip free experience.
3. Crafted for All - Beginners & Professional : Capture professional Quality photographs under perfect light .Anyone can use this equipment. Compatible with Studio Lights, Flash Units, Ring Lights, LED Video Lights, LED Panels Reflectors, Umbrellas, Light lamps, Projectors and others.
5. Handy & Reliable : Discover endless lighting possibilities. Helps you target the light to your subject at any angle. Perfect for Indoor / Outdoor shooting.



1/4 inch
Mounting Thread



Easy Flip Lock



3 Sections



Shock Absorption
Springs



Weight
1 Kg



Maximum Height
6 Feet



Maximum Load
upto 5 kgs

6 Feet

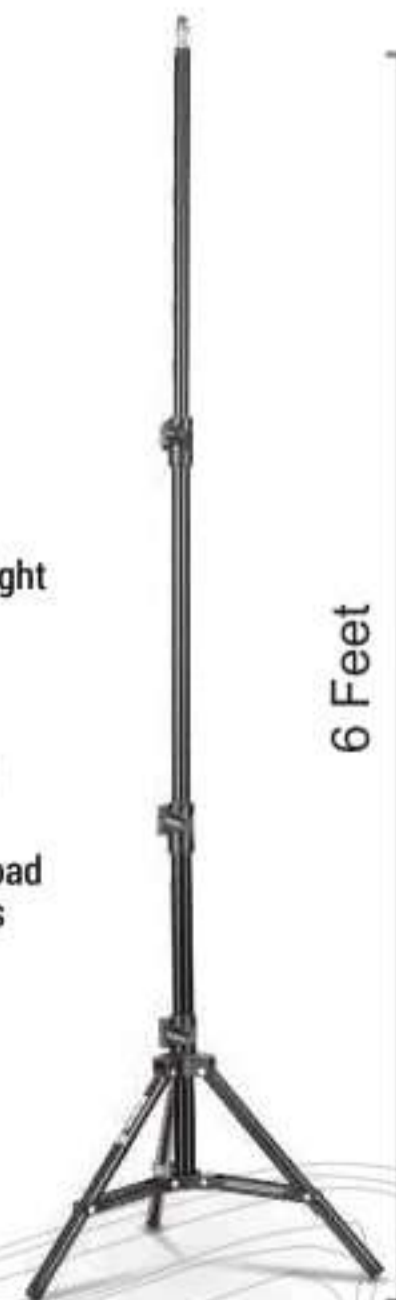

Photographic Light Stand

DLS-006 FT

for Still / Video Photography setup

1. Heavy Duty & Lightweight : **6 Feet Light Stand DLS-006FT** strong enough to hold most equipment yet Compact & Light weight. Can Carry effortlessly from one spot to another locations easily. Offers a collapsible design everything folds in a short, compact size.
2. Jerk Proof : Comes with shock absorption springs mechanism that protects equipment and fingers from damage & requires less efforts to assemble & disassemble. It's all 3 sections are secured with flip locks for better hold and slip free experience.
3. Crafted for All - Beginners & Professional : Capture professional Quality photographs under perfect light .Anyone can use this equipment. Compatible with Studio Lights, Flash Units, Ring Lights, LED Video Lights, LED Panels Reflectors, Umbrellas, Light lamps, Projectors and others.
5. Handy & Reliable : Discover endless lighting possibilities. Helps you target the light to your subject at any angle. Perfect for Indoor / Outdoor shooting.



1/4 inch
Mounting Thread



Easy Flip Lock



3 Sections



Shock Absorption
Springs



Photographic
WHITE SHOOT UMBRELLA
Made with High Grade Fabrics

The Digitek White Shoot Umbrella work to broaden and soften the light source and create a more pleasing overall quality of light than the bare flash itself. Digitek Shoot-through White umbrellas are constructed from translucent white fabric through which the flash passes to produce soft, seamless light. The benefit of working with a shoot-through type of umbrella is that you can place it closer to your subject—the ability to place your light source closer to your subject produces a softer light, which is especially well-suited to wedding photography and portraiture. Its long shaft allows the umbrella to be moved closer to the light source for a narrower beam of soft light or further away for a wide beam of soft light. It allows approximately 50% light transmission. It acts like a very large Softbox at a very low cost. Suitable for all studio flashes. Ideal for Portraits & Object Product Shooting for Portraits & Object Product Shooting.

Available Size : 12" , 19" & 25".

Available in - Metal / Half Metal & PVC

250V WATER PROOF



Premium
PREMIUM HALOGEN TUBE
Double Ended Linear Halogen Tube

Digitek Premium Double ended Linear Halogen Tube maintain lumens throughout lamp life . Consistent color tmperature and long life. Ideal for professional Film & TV work. Theater, Concert Stages, Entertainment, Wedding & other Photo Shoots events etc.High Quality Environment friendly. No flickers and no mercury. Full 360° Beam Angle.

Specifications

- Power : 1000 Watt / 250 Volt
- Lumens : 35000 LUX
- Base : R75
- Average Life : 2000 Hrs.

Best for Porta Light and other Halogen Light models.



Keep

your Photography
Essential Safe



AB-105S

Electronic Dry Cabinet

Horizontal Dry Cabinet Box Digital Display with Automatic Humidity Controller

Capacity	: 105 Liters (100L)
Input voltage	: 110 -220v AC/5V 2A DC
Power	: 5W/H
Humidity Control Mode	: Automation control
Dehumidify Range	: 25%-60%
Display Mode	: LED display
Shelf	: 4PCS
Inner size W x D x H (cm)	: 37.8 x 35.8 x 69
Out size W x D x H (cm)	: 38 x 39 x 77

Adopts the latest TE Cooling Water Design. Activate Cooling Water automatically, the moisture will be condensed & frosted immediately on a collection board. Makes use of the Cooling and Thermal performance of Semi-Conductor waters for raising its Heat-singing capability, Energy saving, Noiselessness and Rapid dehumidification.



Electronic Dry Cabinet

AB-35C

Digitek Electronic Dry Cabinet Storage for DSLR Camera Lens with Slide Trays, Anti Rust Cabinet. Magnetic Sealers Door for best RH Control. High Accuracy $\pm 3\%$.

Features	
1. Capacity	: 35 L
2. Compartment	: 2
3. LCD Display	: Pocket Watch Display
4. Humidity Control	: Manual Knob
5. Humidity Range	: 25% - 60%
6. Power Supply	: 110-220 V
7 Dimension	: 290 x 320 x 408 mm
8. Weight	: 6.18 Kgs



Electronic Dry Cabinet

AB-55S

Digitek Electronic Dry Cabinet Storage for DSLR Camera Lens with Slide Trays, Anti Rust Cabinet. Magnetic Sealers Door for best RH Control. High Accuracy $\pm 3\%$.

Features	
1. Capacity	: 55 L
2. Compartment	: 3
3. Display	: LED Display
4. Humidity Control	: Automatic
5. Humidity Range	: 25% - 60%
6. Power Supply	: 110-220 V
7 Dimension	: 290 x 320 x 605 mm
8. Weight	: 9.1 Kgs



Electronic Dry Cabinet

AD-85HS

Digitek Electronic Dry Cabinet Storage for DSLR Camera Lens with Slide Trays, Anti Rust Cabinet. Magnetic Sealers Door for best RH Control. High Accuracy $\pm 3\%$. Interior LED lights make viewing Easier

Features	
1. Capacity	: 85 L
2. Compartment	: 2
3. Display	: Dimmable LCD Display
4. Humidity Control	: Automatic
5. Humidity Range	: 25% - 60%
6. Power Supply	: 110-220 V
7 Dimension	: 380 mm x 390 mm x 615 mm
8. Weight	: 14 Kgs



Electronic Dry Cabinet

AD-85S

Digitek Electronic Dry Cabinet Storage for DSLR Camera Lens with Slide Trays, Anti Rust Cabinet. Magnetic Sealers Door for best RH Control. High Accuracy $\pm 3\%$. Interior LED lights make viewing Easier

Features	
1. Capacity	: 85 L
2. Compartment	: 3
3. Display	: Dimmable LCD Display
4. Humidity Control	: Automatic
5. Humidity Range	: 25% - 60%
6. Power Supply	: 110-220 V
7 Dimension	: 380 mm x 390 mm x 416 mm
8. Weight	: 13 Kgs

A short, thick horizontal black line is positioned above the main title.

CAMERA ACCESSORIES

Range of

- ✦ Microphone
- ✦ UV Filters
- ✦ Card Readers

Once you have a Video Camera or DSLR there are lots of accessories & upgrades available to make your photographic life easier or help you make take better shots. Take advantage of the new age technology to enhance your photography skill & result with Digitek range of Camera Accessories.





2.4G
Wireless



Type C
Fast Charge



Ultra Clear
Sound



360° Sound
Capture



Mixing
Sound



Distance up to
30 Meters

Wireless MICROPHONE

DWM-101

- 360° Ultra-Clear Pickup/Receive Equal amount of sound from all Directions
- Crystal-Clear Audio For Any Type Of Content Creation
- Built-In DSP Chip Intelligently Filter Noise provide Professional Audio Quality.
- Plug And Play-Automatic Pairing. The Signal Transmission with Low Latency & without Interruption. Suitable For Video Shooting.
- High Performance Wireless Transmission - effective up to 30 meters.
- Connect the Microphone with Bluetooth device for Background Music Recording
- Ultra Stable Signal; Audio & Video Synchronisation
- Enhanced Headphone Monitoring Function, Allowing You To Monitor In Real Time While Shooting. With 3.5mm Interface. With Two 3.5mm Cables, Can Be Used With Laptop/PC/DSLR Camera/Amplifier/DV/Camcorder/Smartphone/Mixer, Etc.

Specifications Transmitter :

Type-C Charging	: DC 5V/1A
Standby Power	: <42uA
Working E-Current	: <33mA
Connection Distance	: 15-30 meter
S/N Ratio	: >75dB
Sensitivity	: 90dB
Battery	: 3.7V/ 400mA Li-Polymer Battery
Working Time	: 10-12 Hours

Specifications Receiver :

Type-C Charging	: DC 5V/1A
Standby Power	: <42uA
Working E-Current	: <33mA
Connection Distance	: 15-30 meter
S/N Ratio	: >75dB
Sensitivity	: 90dB
Frequency Stability	: +10ppm
Audio Output	: 350mv (Max)
Battery	: 3.7V/ 400mA Li-Polymer Battery
Working Time	: 10-12 Hours



Wireless MICROPHONE with Type C Connector

DWM-001



4
Upto Hours
Non Stop
in 1Charge

2.4
Ghz Radio
Frequency

10
Meters
Wireless
Operation
Range

Feature :

1. DigiTek Wireless Microphone DWM-001 with USB-C connector is ideal for enjoying optimal audio quality during your Live Streaming or Professional Online Meetings. It noticeably improves the sound of recordings made with a Smartphone or Tablet Pc's.
2. Simply Clip the Microphone unit to any of your Clothing & Plug the Receiver into your Mobile Device's USB-C port. Then place the Mobile Device in the right place and you're done. Thanks to the transmission by radio waves, you can move up to 10 meters around the receiver without cables.
3. The Receiver's Long lasting Li-Poly battery is powered directly by the mobile device it's plugged into. Thus, it allows you to make audio recordings up to 4 hours in a row.

Specifications

Power	: DC 5V/1A
Radio Frequency	: 2.4Ghz-2.44Ghz
Receiver	: Via USB-C (Via Mobile Device)
Working Current	: ≤11mA
Standby Power Consumption	: ≤ 55uA
Response Frequency Range	: 20HZ-20KHZ
Sensitivity	: 35dBm
Signal-to-noiseRatio	: ≥75dB
Power Supply	: Built-in-50mAh Li-poly battery for to 4 Hours operation. Charging via USB (AC adapter or Power Bank -not included)
Button Description	: Long Press : Turn on/off, Short Press : Mute/Unmute

Wireless MICROPHONE with Lightning Connector

DWM-002



4
Upto Hours
Non Stop
in 1Charge

2.4
Ghz Radio
Frequency

10
Meters
Wireless
Operation
Range

Feature :

1. DigiTek Wireless Microphone DWM-002 with Lightning connector is ideal for enjoying optimal audio quality during your Live Streaming or Professional Online Meetings. It noticeably improves the sound of recordings made with iPhone and iPad.
2. Simply Clip the Microphone unit to any of your Clothing & Plug the Receiver into your Mobile Device's Lightning port. Then place the Mobile Device in the right place and you're done. Thanks to the transmission by Radio Waves, you can move up to 10 meters around the receiver without cables.
3. The Receiver's Long lasting Li-Poly battery is powered directly by the Mobile device it's plugged into. Thus, it allows you to make audio recordings up to 4 hours in a row.

Specifications

Power	: DC 5V/1A
Radio Frequency	: 2.4Ghz-2.44Ghz
Receiver	: Via USB-Lightning Adapter (Via iPhone)
Working Current	: ≤11mA
Standby Power Consumption	: ≤ 55uA
Response Frequency Range	: 20HZ-20KHZ
Sensitivity	: 35dBm
Signal-to-noiseRatio	: ≥75dB
Power Supply	: Built-in-50mAh Li-poly battery for to 4 Hours operation. Charging via USB (AC adapter or Power Bank -not included)

Button Description :

Long Press	: Turn on/off
Short Press	: Mute/Unmute.

Wireless MICROPHONE with Type C Connector

DWM-003

Feature :

1. Consists of 1 Receiver with Type-C Connector & 2 Microphone (can entertain dual Respondent at the same time). Ideal for enjoying Optimal Audio Quality During your Live Streaming or Online Meetings. It noticeably improves the sound of recordings.
2. Simply Clip both the Microphones to Clothing & plug the Receiver into your Mobile Device's USB-C Port. Then Place the mobile Device in the right place & you're done. Due to transmission by Radio Waves, you can move up to 10meters between the Receiver wirelessly. The Receiver is powered directly by the mobile device, it's plugged into. the Microphone is powered by Li-Polymer battery Which allows you to make audio recordings up to 4 hours in a row.

Specifications

Power	: DC 5V/1A
Radio Frequency	: 2.4Ghz-2.44Ghz
Receiver	: Via USB-C Type (Via Mobile Device)
Working Current	: ≤11mA
Standby Power Consumption	: ≤ 55uA
Response Frequency Range	: 20HZ-20KHZ
Sensitivity	: 35dBm
Sampling Rate	: 48K
Signal-to-noiseRatio	: ≥75dB
Power Supply	: Built-in-50mAh Li-poly battery for to 4 Hours operation. Charging via USB (AC adapter/Power Bank -not included)

Button Description

: Long Press : Turn on/off, Short Press:Mute Unmute.



4
Upto Hours Non Stop
in 1 Charge

2.4
Ghz Radio
Frequency

10
Meters Wireless
Operation Range

Wireless MICROPHONE with Lightning Connector

DWM-004 LTC

Feature :

1. DigiTek Wireless Microphone DWM-004, Consists of 1 Receiver with Lightning Connector & 2 Microphone (can entertain dual Respondent at the same time). Ideal for enjoying Optimal Audio Quality During your Live Streaming or Online Meetings. It noticeably improves the sound of recordings made with a Smartphone or Tablet Pc's.
2. Simply Clip both the Microphones to Clothing & plug the Receiver into your iPhone / iPad Lightning Port. Then Place the mobile Device in the right place and you're done. Due to transmission by Radio Waves, you can move up to 10meters between the Receiver wirelessly. The Receiver is powered directly by the mobile device, it's plugged into. The Microphone is powered by Li-Polymer battery Which allows you to make audio recordings up to 4 Hrs.

Specifications

Power	: DC 5V/1A
Radio Frequency	: 2.4Ghz-2.44Ghz
Receiver	: Via Lightning connector (into iPhone/ iPad Lightning Port)
Working Current	: ≤11mA
Standby Power Consumption	: ≤ 55uA
Response Frequency Range	: 20HZ-20KHZ
Sensitivity	: 35dBm
Sampling Rate	: 48K
Signal-to-noiseRatio	: ≥75dB
Power Supply	: Built-in-50mAh Li-poly battery for to 4 Hours operation. Charging via USB (AC adapter or Power Bank -not included)

Button Description

: Long Press : Turn on/off, Short Press : Mute / Unmute.



4
Upto Hours Non Stop
in 1 Charge

2.4
Ghz Radio
Frequency

10
Meters Wireless
Operation Range

Wireless 3.5mm AUX Jack

DWM-005 AUX

Feature :

1. DigiTek Wireless Microphone DWM-005, Consists of 1 Receiver with 3.5mm Aux Jack & 1 Microphone ideal for enjoying Audio Quality during your Live Streaming or Professional Online Meetings. It noticeably improves the sound of Recording.
2. Simply Clip both the Microphones to Clothing & plug the Receiver into your Mobile Device's Aux 3.5mm Jack. Then place the mobile Device in the right place & you're done. Transmission by radio waves, you can move up to 10 meters around the receiver without cables. The receiver is powered directly by the mobile device, it's plugged into. the Microphone is powered by Li-Polymer Battery which allows you to make audio recordings up to 4 hours in a row.

Specifications

Power	: DC 5V/1A
Radio Frequency	: 2.4Ghz-2.44Ghz
Receiver	: Via Aux 3.5mm Jack (via Mobile Device Lightning Port)
Working Current	: ≤11mA
Standby Power Consumption	: ≤ 55uA
Response Frequency Range	: 20HZ-20KHZ
Sensitivity	: 35dBm
Signal-to-noiseRatio	: ≥75dB
Power Supply	: Built-in-50mAh Li-poly battery for to 4 Hours operation. Charging via USB (AC adapter or Power Bank -not included)

Button Description

: Long Press : Turn on/off, Short Press : Mute / Unmute.



4
Upto Hours Non Stop
in 1 Charge

2.4
Ghz Radio
Frequency

10
Meters Wireless
Operation Range



16 LAYER COATING



UV Protection Lens Filter

MC UV FILTERS

Digital MC UV Filter will select light rays that enters in your camera lens. It will allow you to remove unwanted reflections from non metallic surface as water, glass etc. Constant use of this filter is recommended for clear picture as well as lens protector

Available size :

49mm, 52mm, 55mm, 58mm, 62mm, 67mm, 72mm, 77mm, 82mm, 86mm

Specifications :

- Multi Coated
- Digital High Definition
- High Index Optical Glass
- Effective Light Transmission
- Absorbs the Ultraviolet Rays, which makes outdoor photography & indistinct.



Digital

UV FILTERS

Digital UV Filter will select light rays that enters in your camera lens. It will allow you to remove unwanted reflections from non metallic surface as water, glass etc.

Constant use of this filter is recommended for Clear Picture & Lens protection. A must for every lens! This UV(0) lens filter absorbs the Ultraviolet Rays which often makes outdoor photography hazy and indistinct. Also serves to protect the lens from scratching, dirt & dust.

Available Sizes :

49mm, 52mm, 55mm, 58mm, 62mm, 67mm, 72mm, 77mm, 82mm, 86mm



USB 3.0 High-Speed Multi Card Reader

DCR-006

USB 3.0 Card Reader DCR-006 is able to read the most popular memory cards available in the market. With Compact design & size , it can be easily connected through PC with USB port .

Specifications:

- Input Voltage : 5V DC
- Input Current : 100-200mA
- USB 3.0 High Speed Card Reader with LED indicator
- Read High Speed Micro SD/ SD/ SDHC/ SDXC Memory Card directly.
- Browse or edit files in computer directly.
- Support Plug n Play
- Easy to Carry, High Speed 5.0 Gbps download & upload. 640MB/s transmission bandwidth
- Supports Windows or MAC OS 8.6/9 or above. for Window 98 required driver, which can be download.
- Also Compatible with USB2.0 & 1.1 also.



USB 3.0 High-Speed Multi Card Reader

DCR-022

Features

- USB 3.0 High-Speed Multi-Card Reader
- Plug & Play
- IC: High-Speed Original Imported USB 3.0
- Compact Streamline Design
- External USB Cable
- USB Powered (No External Power Required)

Specifications:

- Read & Write Support: M2/Micro SD Slot: MS Micro(M2)/Micro
- SD/T-FLASH;SD Slot: SD/SDHC/SDXC; CF Slot: Compact Flash (CF) ; MS Slot: Memory Stick (MS).
- Supported Operated Systems: Windows 7/8/10 or Higher, Mac OS 10.07 or Higher.

PLATINUM EXTRA POWER
LI-ION
BATTERIES
FOR DSLR & CAMCODER



V MOUNT BATTERY

DV 003 4S6P (BP 222)



D TAP x 2
Charging Port
10.8-16.8V

Output
2 x USB
5V / 2A

Digitek Platinum V Mount/V Lock Battery - 222Wh 14.8V 15000mAh Rechargeable Li-ion Battery for Broadcast Video Camcorder, Compatible with Sony HDCAM, XDCAM, Digital Cinema Cameras and Other Camcorders.

Compatibility

Standard V Mount/V Lock Battery : Ideal Replacement and Rechargeable lithium-ion battery for Digital Cinema Cameras Sony Video Camera Camcorder Broadcast. Compatible with HVR-S270C PMW-EX330K PMW-EX330L, PMW-580K PMW580L, PDW-680 PDW-700 PDW-850, PMW-TD300, HDW-F900R HDW-680 HDW-800P, PMW-F55 PMW-F5, etc.

Smart LED Indicator : 5-Level LED Indicator displays remaining charge, super-long lasting charge for each use and more than 500 full recharge cycles over life of the battery. Smart LED on the V Mount/V Lock Battery shows your battery charging process, easy to check the charging status.

Equipped with the newest generation of CPU control, IC chip, double PCB panel to deliver super power for improved performance. Features with four layers of protection (over-charging, short-circuit, high-temperature, and surge protection). Can be charged or discharged at any time without harm.

Also Available

DV 003 4S5P (BP 180) - 12500mAh

DV 004 4S4P (BP 150) - 10000mAh



Input
AC 100-240V
50/60Hz

Output
DC 16.8-3A

V Mount Battery Charging Adaptor

DPUC-015

Digitek Platinum V Mount battery Charging Adaptor DPUC-015 for V Mount Batteries. Compatible with all cameras using V Mount / V Lock / Gold mount batteries. Compatible with: Sony BP-U65, BP-U68, HVR-S270C PMW-EX330K PMW-EX330L, PMW-580K PMW-580L, PDW-680 PDW-700 PDW-850, PMW-TD300, HDW-F900R HDW-680 HDW-800P, PMW-F55 PMW-F5 etc.

Fast Charging & Safety: Fast charge with automatic constant current control prevents battery from overcharging, short circuit, over current and electronic shock.

Charger Indicator: Red light is for charging, green light for fully charged. Easy to tell if the battery is fully charged.

Multi-Protection, Safe and Reliable

- 
Short Circuit
Protection
- 
Over Discharge
Protection
- 
Over Current
Protection
- 
Over Charge
Protection
- 
Over Heating
Protection

Specifications

- Model : DPUC-015
- Input : AC 100-240V 50/60Hz
- Output : DC 16.8 -3A

Platinum Rechargeable Battery for SONY F-990 C

Compatible Model

For SONY PD150 / 150P / 170 / 170P / TR1 / 200 / 300 / 3000 / 500 / 5 / 17 / 910 / 940 / V119 / V15 / V16 / V25 / TRV3000 / 36 / 3718 / TRV4 / TRV41 / TRV43 / TRV46 / TRV51 / TRV518 / 9E / 98E / 120E / 130E / 320E / 420E / 520E / 820E / 16E / 21E / 57E / 66E / 67E / 87E / 210E / 250E / 320E / 410E / 520E / 720E / 820E / 900E / 100E / 150P / TR3 / A700 / D800 / SC5 / DCR-SD1000 / DCR-SR40 / DCR-TRV900 / DCR-VX-1000 / VX1000E / VX2000 / VX2000E / DCR-VX2100 / VX2100E / DCR-VX2200 / VX-9000 / HDR-AX2000 / HDR-FX1 / HDR-FX7 / HDR-FX1000 / HVR-HD1000 / HVR-V1 / HVR-Z1 / Z5 / Z7 / HXR-MC1500 / MC2000 / HXR-NX5 / NEX-EA50 / FS100 / FS700 / Sony HVL-20DW2 Video Light.

Specifications

Cell Type: Li-ion Voltage: 7.4V Capacity: 1600mAh 118.4Wh



Platinum Rechargeable Battery for SONY FW 50

Compatible Model

For Sony ZV-E10, Sony Alpha A3000, A5000, A5100, A6000, A6100, A6300, A6400, A6500, A7000, A7, A7 II, A7R, A7R II, A7S, A7S II, RX10, RX10 II, RX10 III, RX10 IV, NEX-3/5/6/7 Series, NEX-3N, NEX-C3, NEX-5, NEX-5T, NEX-5R, NEX-6, NEX-7, NEX-F3, SLT-A33, A35, A37, A55, SLT-A55V,

Specifications

Cell Type: Li-ion Voltage: 7.4V Capacity: 2100mAh 15.5Wh



Platinum Rechargeable Battery for SONY NP FZ-100

Compatible Model

For SONY Alpha A7 III, A 1, A7 IV, A7 C, A7 R III, A7 R IV, A7 RSV, A7 M3, A7 S3, A9, A9 II, Sony FX30, A6600

Specifications

Cell Type: Li-ion Voltage: 7.4V Capacity: 2280mAh 16.42Wh



Platinum Rechargeable Battery for CANON LP-E6 /LP-E6H

Compatible Model

For Canon XC10 / XC15 / EOS 60D / EOS 60Da / EOS 70D / EOS 80D / EOS 90D / EOS 5D Mark II / EOS 5D Mark III / EOS 5D Mark IV / EOS 5Ds / 5Ds R / EOS 6D / EOS 6D Mark II / EOS 7D / EOS 7D Mark II, EOS R/RA, R5 / R5 / R5 Mark II / R7

Specifications

Cell Type: Li-ion Voltage: 7.4V Capacity: 2100mAh 15.5Wh (LP-E6)
7.4V Capacity: 2400mAh 17.7Wh (LP-E6H)



Platinum Rechargeable Battery for CANON LP-E17

Compatible Model

Canon EOS M3, M5, M6, M6 Mark II, 77D, 200D, 750D, 760D, 800D, 8000D, 9000D, Rebel T6s, T6i, T7i, SL2, Kiss X8i Cameras, R 10

Specifications : Cell Type: Li-ion Voltage: 7.4V Capacity: 1250mAh 9.3Wh



Platinum Rechargeable Battery for NIKON EN-EL 14

Compatible Model

Nikon D3100, D3200, D3300, D3400, D3500, D5100, D5200, D5300, D5500, D5600, DF DSLR, Coolpix P7000, P7100, P7700 & P7800

Specifications

Cell Type: Li-ion Voltage: 7.4V Capacity: 1400mAh 10.3Wh



Platinum Rechargeable Battery for NIKON EN-EL 15 /15C

Compatible Model

For Nikon D7000, D7100, D7200, D850, D750, D810, D500, D600, D610, D7500, D800, D800E, V1, Z7, Z7II, Z6, A6 II & Z 5,

Specifications

Cell Type: Li-ion Voltage: 7.4V Capacity: 2100mAh 15.5Wh (EN-EL15)
7.4V Capacity: 2500mAh 18.5Wh (EN-EL15C)



Platinum Rechargeable Battery for NIKON EN-EL 25

Compatible Model

For NIKON Z30 / Z50 & Z FC

Specifications

Cell Type: Li-ion Voltage: 7.6V Capacity: 1600mAh 12.2Wh



Platinum Rechargeable Battery for HERO 8 BLACK

Compatible Model

For GO PRO HERO 8/7/6/5 BLACK

Specifications

Cell Type: Li-ion Voltage: 3.85V Capacity: 1220mAh 4.7Wh



Platinum Rechargeable Battery for SONY F-980

Compatible Model

For SONY PD150 / 150P / 170 / 170P / TR1 / 200 / 300 / 3000 / 500 / 5 / 17 / 910 / 940 / V119 / V15 / V16 / V25 / TRV3000 / 36 / 3718 / TRV4 / TRV41 / TRV43 / TRV46 / TRV51 / TRV518 / 9E / 98E / 120E / 130E / 320E / 420E / 520E / 820E / 16E / 21E / 57E / 66E / 67E / 87E / 210E / 250E / 320E / 410E / 520E / 720E / 820E / 900E / 100E / 150P / TR3 / A700 / D800 / SC5 / DCR-SD1000 / DCR-SR40 / DCR-TRV900 / DCR-VX-1000 / VX1000E / VX2000 / VX2000E / DCR-VX2100 / VX2100E / DCR-VX2200 / VX-9000 / HDR-AX2000 / HDR-FX1 / HDR-FX7 / HDR-FX1000 / HVR-HD1000 / HVR-V1 / HVR-Z1 / Z5 / Z7 / HXR-MC1500 / MC2000 / HXR-NX5 / NEX-EA50 / FS100 / FS700 / Sony HVL-20DW2 Video Light.

Specifications

Cell Type: Li-ion Voltage: 7.4V Capacity: 12000mAh 88.8Wh



Platinum Rechargeable Battery for VB-18

Compatible Model

For Godox Ving V850 V860C V860N

Specifications

Cell Type: Li-ion Voltage: 11.1V Capacity: 2600mAh 28.9Wh



Platinum Rechargeable Battery for PHANTOM 4

Fits with Phantom 4 series Drones & Phantom 4 battery charger. 15.2V 5870mAh 89.22Wh Li-ion cells for 18-28 min. flying time. Built-in intelligent charge & discharge protecting IC. Inbuilt circuit to prevent batteries from short-circuit, over-heat & overcharging. 4 LED indicators shows the remaining power



Platinum Rechargeable Battery for MAVIC PRO

Compatible Model

Platinum Pack For Mavic Pro gives a flight time of up to 27 minutes and its own integrated battery-management system takes into account everything from remaining voltage, amount of power being used, temperature & more to calculate remaining flight times. So you are always updated when to head home. Its protection mechanism is to prevent overcharging & over draining, to avoid damage of battery permanently. When flying in cold temperature or plan to fly on a winter break, low-temperature protection will activate.

Specifications

- Advanced LiPo 3S Battery
- Operating temperature: 5° Celsius to 40° degree Celsius
- Built-in sensors & Bright LEDs shows power remains in battery
- Compatible with the Mavic Pro series
- Battery Capacity : 3830mAh / 11.4V



Platinum Rechargeable Battery for FUJI NP-FW126

Compatible Model

X A1, X A2, X A3, A5-X, X A10, X-E1, E2-X, X-E2S X-E3-X M1, X Pro1, Pro2 X-X-T1, T2-X, X-T10, T20-X, XA2, X100F, Finepix HS30, HS30EXR, HS33EXR, HS35EXR, HS50EXR

Specifications

Cell Type: Li-ion Voltage: 7.2V Capacity: 1200mAh 8.6Wh



Platinum Rechargeable Battery for HERO DBG-567

Compatible Model

For Hero 5 / Hero 6 / Hero 7 / Hero 2018 Black

Specifications

Cell Type: Li-ion Voltage: 3.85V Capacity: 1250mAh 4.8Wh



Platinum Rechargeable Battery for HERO 9 BLACK

Compatible Model

For GO PRO HERO 9 BLACK

Specifications

Cell Type: Li-ion Voltage: 3.85V Capacity: 1720mAh 6.62Wh



FOR SONY

BN -1

- Cell Type : Li-ion
- Voltage : 3.7V
- Capacity : 1400mAh

PART NO.

for Sony DSC-WX80,DSC-WX70,DSC-WX60,DSC-WX50,DSC-WX30,DSC-WX220,DSC-WX200,DSC-WX170,DSC-WX150,DSC-W830,DSC-W810,DSC-W800,DSC-W730,DSC-W710,DSC-W690,DSC-W670,DSC-W650,DSC-W620,DSC-W610,DSC-W570D,DSC-W570,DSC-W550,DSC-W530,DSC-W520,DSC-W510,DSC-W380,DSC-W360,DSC-W350,DSC-W330,DSC-W320,DSC-W310,DSC-QX30,DSC-QX100,DSC-QX10,DSC-TX9,DSC-TX7,DSC-TX66,DSC-TX55,DSC-TX5,DSC-TX300V,DSC-TX20,DSC-TX200V,DSC-TX20,DSC-TX100V,DSC-T990,DSC-T99,DSC-T110D,DSC-T110,DSC-J20



FV -100

- Cell Type : Li-ion
- Voltage : 3.7V
- Capacity : 2200mAh

PART NO.

FV-100, FH-100 & FP-90

Sony Handycam SR-68, SR-88, SX-44, SX-63, SX-83, HDR-CX110, HDR-CX100, HDR-CX150, HDR-CX300, HDR-CX350V, HDR-CX550V, HDR-XR150, HDR-XR350



F-960 / F-970 MU

- Cell Type : Li-ion
- Voltage : 7.4V
- Capacity : 9000mAh 66.6Wh

PART NO.

NP-F930, 930/B, NP-F950, NP-F950/B, NP-F960, NP-970, NP-F970, NP-F970/B, F-750

For SONY PD150 / 150P / 170 / 170P / TR1 / 200 / 300 / 3000 / 500 / 5 / 17 / 910 / 940 / V119 / V15 / V16 / V25 / TRV3000 / TRV36 / TRV3718 / TRV4 / TRV41 / TRV43 / TRV46 / TRV51 / TRV5718 / 9E / 98E / 120E / 130E / 320E / 420E / 520E / 820E / 16E / 21E / 57E / 66E / 67E / 87E / 210E / 250E / 320E / 410E / 520E / 720E / 820E / 900E / 100E / 150P / TR3 / A700 / D800 / SC5 / DCR-SD1000 / DCR-SR40 / DCR-TRV900 / DCR-VX-1000 / VX1000E / VX2000 / VX2000E / DCR-VX2100 / VX2100E / DCR-VX2200 / VX-9000 / HDR-AX2000 / HDR-FX1 / HDR-FX7 / HDR-FX1000 / HVR-HD1000 / HVR-V1 / HVR-Z1 / HVR-Z5 / HVR-Z7 / HXR-MC1500 / HXR-MC2000 / HXR-NX5 / NEX-EA50 / NEX-F5100 / NEX-F5700 / Sony HVL-20DW2 Video Light.

Can charge by Wall Adapter, Car Charger & Power Bank via Micro USB cable.

F-960 / F-970 D

- Cell Type : Li-ion
- Voltage : 7.4V
- Capacity : 9000mAh 66.6Wh

PART NO.

NP-F930, NP-F930B, NP-F950, NP-F950B, NP-F960, NP-F970, NP-F970B, NP-F550, NP-F750

For SONY PD150 / 150P / 170 / 170P / TR1 / 200 / 300 / 3000 / 500 / 5 / 17 / 910 / 940 / V119 / V15 / V16 / V25 / TRV3000 / TRV36 / TRV3718 / TRV4 / TRV41 / TRV43 / TRV46 / TRV51 / TRV5718 / 9E / 98E / 120E / 130E / 320E / 420E / 520E / 820E / 16E / 21E / 57E / 66E / 67E / 87E / 210E / 250E / 320E / 410E / 520E / 720E / 820E / 900E / 100E / 150P / TR3 / A700 / D800 / SC5 / DCR-SD1000 / DCR-SR40 / DCR-TRV900 / DCR-VX-1000 / VX1000E / VX2000 / VX2000E / DCR-VX2100 / VX2100E / DCR-VX2200 / VX-9000 / HDR-AX2000 / HDR-FX1 / HDR-FX7 / HDR-FX1000 / HVR-HD1000 / HVR-V1 / HVR-Z1 / HVR-Z5 / HVR-Z7 / HXR-MC1500 / HXR-MC2000 / HXR-NX5 / NEX-EA50 / NEX-F5100 / NEX-F5700 / Sony HVL-20DW2 Video Light.



NP-BG/FG1

- Cell Type : Li-ion
- Voltage : 3.7V
- Capacity : 960mAh

Sony Cyber-shot W-80, W290, H20, H55, W120, W220, W230, W150, W50, H7, N2, W90, H10, H9, W100, T100, W70, T20, H50, W200, Sony Cyber-shot H-3, Sony Cyber-shot H-7, Sony Cyber-shot H-50, Sony Cyber-shot H-50/B, Sony Cyber-shot N-1, Sony Cyber-shot T-100, Sony Cyber-shot T-20, Sony Cyber-shot W-100, Sony Cyber-shot W-120, Sony Cyber-shot W-120/P, Sony Cyber-shot W-150, Sony Cyber-shot W-170, Sony Cyber-shot W-30 & Sony Cyber-shot W-300 range.



NP-F750

- Cell Type : Li-ion
- Voltage : 7.4V
- Capacity : 5200mAh 38.5Wh

PART NO.

Sony NP-F730, NP-F750, NP-F760, NP-F770 Battery

For Sony CCD-TRV215 CCD-TR917 CCD-TR315 HDR-FX1000 HDR-FX7 HVR-V1U HVR-Z7U HVR-Z5U Camcorder.



F-750 MU

- Cell Type : Li-ion
- Voltage : 7.4V
- Capacity : 5200mAh 38.5Wh

PART NO.

Sony NP-F730, NP-F750, NP-F760, NP-F770 Battery

For Sony CCD-TRV215 CCD-TR917 CCD-TR315 HDR-FX1000 HDR-FX7 HVR-V1U HVR-Z7U HVR-Z5U Camcorder.

More Convenient to Charge: Can also charge via a Wall Charger, Car Charger or even a Power Bank.

NP-BX-1

- Cell Type : Li-ion
- Voltage : 3.7V
- Capacity : 1240mAh

SONY DSC-RX100



NP-FZ100

- Cell Type : Li-ion
- Voltage : 7.2V
- Capacity : 2280mAh 16.4Wh

For SONY Alpha A7 iii, A7 R iii, A9, A7 M3, A7 S3,



FOR CANON

NB 6L

- Cell Type : Li-ion
- Voltage : 3.7V
- Capacity : 1000mAh

Canon Powershot SD4000IS, SD980IS, SD770IS, SD1200IS, S95, S90, D10 Digital IXUS 85IS, 25IS



LP E5

- Cell Type : Li-ion
- Voltage : 7.4V
- Capacity : 1080mAh

Canon EOS Rebel XSi, XS, T1i EF-S, EOS Kiss X2, X1, 500D, 450D, 1000D & Digital Rebel XS



LP E10

- Cell Type : Li-ion
- Voltage : 7.4V
- Capacity : 860mAh 6.4Wh

EOS 1100D, 1200D, 1300D, EOS Kiss X50, Kiss X70, EOS Rebel T3, T5, T6

NB 8L

- Cell Type : Li-ion
- Voltage : 3.7V
- Capacity : 740mAh

Canon Powershot A3000IS, A3100IS Series



LP-E6

- Cell Type : Li-ion
- Voltage : 7.4V
- Capacity : 1800mAh 13.3Wh

Canon XC10 / XC15 / EOS 60D / EOS 60Da / EOS 70D / EOS 80D / EOS 5D Mark II / EOS 5D Mark III / EOS 5D Mark IV / EOS 5Ds / 5DSR / EOS 6D / EOS 6D Mark II / EOS 7D / EOS 7D Mark II



LP-E12

- Cell Type : Li-ion
- Voltage : 7.4V
- Capacity : 875mAh 6.5Wh

Canon EOS M, M2, M10, M50, M100, 100D, Kiss M, Kiss X7, Rebel SL1, Power Shot SX70 HS

NB 11L

- Cell Type : Li-ion
- Voltage : 3.7V
- Capacity : 690mAh

Canon IXUS 125HS, IXUS 125HS, IXUS 240HS, Powershot A12000, Powershot A2200, Powershot A2300, Powershot A2400 IS, Powershot A3200IS, Powershot A3300IS, Powershot A3400IS, Powershot A3400, Powershot A4000, Powershot A4000 IS



LP-E8

- Cell Type : Li-ion
- Voltage : 7.4V
- Capacity : 1120mAh 8.3Wh

Canon Power EOS 550D, 600D, 650D, 700D, EOS Kiss X4, X5, X6i, X7i, EOS Rebel T2i, T3i, T4i & T5i.



LP E 17

- Cell Type : Li-ion
- Voltage : 7.2V
- Capacity : 1040mAh 7.5Wh

EOS 77D, M3, M5, M6, EOS Rebel, T7i, T6i, T6s, SL2, EOS 200D, 750D, EOS 760D, EOS 800D, 8000D, 9000D, Kiss X8i

FOR NIKON

EN-EL3E



- Cell Type : Li-ion
- Voltage : 7.4V
- Capacity : 1500mAh

Nikon D700, D300, D300S, D200, D100, D90, D80, D70 & D50

PART NO.

EN-EL-14



- Cell Type : Li-ion
- Voltage : 7.4V
- Capacity : 1030mAh 7.6Wh

Nikon D3100, D3200, D3300, D3400, D3500, D5100, D5200, D5300, D5500, D5600, DF DSLR, Coolpix P7000, P7100, P7700 & P7800

PART NO.

EN-EL9



- Cell Type : Li-ion
- Voltage : 7.4V
- Capacity : 1080mAh

EN-EL9, EN-EL9a, EN-EL9e

PART NO.

Nikon D5000, D3000, D60, D40X & D40

EN-EL-15



- Cell Type : Li-ion
- Voltage : 7.4V
- Capacity : 1900mAh 14.1Wh

Nikon D7000, D7100, D7200, D850, D750, D810, D500, D600, D610, D7500, D800, D800E, & V1

PART NO.

EN-EL10



- Cell Type : Li-ion
- Voltage : 3.7V
- Capacity : 650mAh

Nikon Coolpix S80, Nikon Coolpix S200, Nikon Coolpix S205, Nikon Coolpix 210, Nikon Coolpix S220, Nikon Coolpix S230, Nikon Coolpix S500, Nikon Coolpix S510, Nikon Coolpix S520, Coolpix S5200 & many more

PART NO.

EN-EL-19



- Cell Type : Li-ion
- Voltage : 3.7V
- Capacity : 700mAh

Nikon Coolpix 775, 880, E880, 885, 995, 4300, 4500, 4800, 5000, 5400, 5700, 8700

PART NO.

FOR PANASONIC

BLC-12



- Cell Type : Li-ion
- Voltage : 7.2V
- Capacity : 1200mAh 8.7Wh

Lumix DMC-GH2, DMC-G5, DMC-G6, DMC-FZ200, DMC-FZ1000, DMC-G7, GH2, GX8, FZ-2500, FZ-2000, GC-D90, GC-D95

PART NO.

D-54S



- Cell Type : Li-ion
- Voltage : 7.4V
- Capacity : 9000mAh 66.6Wh

For Panasonic AG-DVC7 / DVC15 / DVC30 / 60 / AG-DVX100A / EX1 / 3 / MX300 / 500 / 7 / 5 / 1 / NV-DS11 / DS150 / DS25 / DS27 / DS28 / DS29 / DS30 / DS33 / DS37 / D538 / DS55 / D560 / DS77 / DS8 / DS99 / VSETKY KAMERY RADY GS1 / GS11 / GS15 / RADY GS3 / GS4 / GS5 / GX and VSETKY S / AG-HVX200 / AJ-PCS060G / PV-DBP8 / DVP8A / DV102 / DV103 / DV203 / DV400 / DV52 / DV53 / DV910.

PART NO.

VW VBG-6



- Cell Type : Li-ion
- Voltage : 7.4V
- Capacity : 9000mAh 66.6Wh

For PANASONIC AG-AC130, AG-AC160, AG-AF100, AG-AF100A, AG-HMC70, AG-HMC150

FOR FUJI

NP-W235



- Cell Type : Li-ion
- Voltage : 7.4V
- Capacity : 3500mAh

For FUJIFILM X-T4 Mirror Less Camera

PART NO.





Micro USB & Type C Port for Charging



Multi Li-ion Battery LCD Charger Combo

DPUC-014 D LP-E6

With 2 Digitek Platinum LP-E6 Li-ion Battery

Dual Port Li-ion Battery charger + 2 x LP E6 Li-ion Batteries Combo. Light Weight with Dual Slot for charging. Having LCD Display for Battery Charging Status & Micro USB Port for Input & Type C Port for external Device charging. Can charge Batteries with USB Adapter, Power Bank, Laptop or Car USB Port which is available. Over Voltage, Over Current or Short Circuit protection.

Specifications:

Input Voltage	: 5V 2.1A (Micro USB Port)
Battery Charging Current	: Channel 1 - 700±60mA Channel 1 - 700±60mA
Output	: 8.4V
Charging Status	: LCD Indicator
Operating Temperature	: 0°~35°
Dimension / Weight	: 90 x 56.2 x 24 mm / 30gms



Micro USB & Type C Port for Charging



Multi Li-ion LCD Charger + LP-E17 Batteries Combo

DPUC-014 D LP-E17

With 2 Digitek Platinum LP-E17 Li-ion Battery

Dual Port Li-ion Battery charger + 2 x LP E17 Li-ion Batteries Combo. Light Weight with Dual Slot for charging. Having LCD Display for Battery Charging Status & Micro USB Port for Input & Type C Port for external Device charging. Can charge Batteries with USB Adapter, Power Bank, Laptop or Car USB Port which is available. Over Voltage, Over Current or Short Circuit protection.

Specifications:

Input Voltage	: 5V 2.1A (Micro USB Port)
Battery Charging Current	: Channel 1 - 700±60mA Channel 1 - 700±60mA
Output	: 8.4V
Charging Status	: LCD Indicator
Operating Temperature	: 0°~35°
Dimension / Weight	: 90 x 56.2 x 24 mm / 30gms



Micro USB & Type C Port for Charging



Multi Li-ion Battery LCD Charger Combo

DPUC-014 D FW 50

With 2 Digitek Platinum FW-50 Li-ion Battery

Dual Port Li-ion Battery charger + 2 x Platinum FW-50 Li-ion Batteries Combo. Light Weight with Dual Slot for charging. Having LCD Display for Battery Charging Status & Micro USB Port for Input & Type C Port for external Device charging. Can charge Batteries with USB Adapter, Power Bank, Laptop or Car USB Port which is available. Over Voltage, Over Current or Short Circuit protection.

Specifications:

Input Voltage	: 5V 2.1A (Micro USB Port)
Battery Charging Current	: Channel 1 - 700±60mA, Channel 1 - 700±60mA
Output	: 8.4V
Charging Status	: LCD Indicator
Operating Temperature	: 0°~35°
Dimension / Weight	: 90 x 56.2 x 24 mm / 30gms



Micro USB & Type C Port for Charging



Multi Li-ion Battery LCD Charger Combo

DPUC-014 D FZ 100

With 2 Digitek Platinum FZ-100 Li-ion Battery

Dual Port Li-ion Battery Charger + 2 x Platinum FZ-100 Li-ion Batteries Combo. Light Weight with Dual Slot for charging. Having LCD Display for Battery Charging Status & Micro USB Port for Input & Type C Port for external Device charging. Can charge Batteries with USB Adapter, Power Bank, Laptop or Car USB Port which is available. Over Voltage, Over Current or Short Circuit protection.

Specifications:

Input Voltage	: 5V 2.1A (Micro USB Port)
Battery Charging Current	: Channel 1 - 700±60mA, Channel 1 - 700±60mA
Output	: 8.4V
Charging Status	: LCD Indicator
Operating Temperature	: 0°~35°
Dimension / Weight	: 90 x 56.2 x 24 mm / 30gms



Multi Li-ion Battery Charger Combo

DPUC-010 E6

With 2 Digitek Platinum LP-E6 Li-ion Battery

Digitek Li-ion Battery Charger DPUC-010 Combo Pack with LP-E6 Li-ion Camera Batteries. Can Charge Two batteries at a time. The charging is controlled by MCU & the charging control is accurate.

Specifications:

Model No.	: DPUC-010
Applications	: Li-ion Battery
Input	: Micro USB 5V / 2A
Input Power	: 10W (Maximum)
Output	: DC 8.4V 800mA x 1 / 550mA x 2
Working Temperature	: 0°C-40°C
Color	: Black
Certifications	: CE, RoHS, BIS



Multi Li-ion Battery Charger Combo

DPUC-010 EN-EL14

With 2 Digitek EN-EL14 Li-ion Battery

Digitek Li-ion Battery Charger DPUC-010 Combo Pack with EN-EL14 Li-ion Camera Batteries. Can Charge Two batteries at a time. The charging is controlled by MCU & the charging control is accurate. Over Voltage, Over Current or Short Circuit protection.

Specifications:

Model No.	: DPUC-010
Applications	: Li-ion Battery
Input	: Micro USB 5V / 2A
Input Power	: 10W (Maximum)
Output	: DC 8.4V 800mA x 1 / 550mA x 2
Working Temperature	: 0°C-40°C
Color	: Black
Certifications	: CE, RoHS, BIS



Multi Li-ion Battery Charger Combo

DPUC-010 EN-EL15

With 2 Digitek Platinum EN EL15 Li-ion Battery

Digitek Li-ion Battery Charger DPUC-010 Combo Pack with EN-EL15 Li-ion Camera Batteries. Can Charge Two batteries at a time. The charging is controlled by MCU & the charging control is accurate. Over Voltage, Over Current or Short Circuit protection.

Specifications:

Model No.	: DPUC-010
Applications	: Li-ion Battery
Input	: Micro USB 5V / 2A
Input Power	: 10W (Maximum)
Output	: DC 8.4V 800mA x 1 / 550mA x 2
Working Temperature	: 0°C-40°C
Color	: Black
Certifications	: CE, RoHS, BIS



Micro USB & Type C Port for Charging

Multi Li-ion Battery LCD Charger

DPUC-014D

For LP-E17 Li-ion Battery

Multi Li-ion Battery LCD Charger DPUC-014 D is Light Weight with Dual Slot for LP-E17 Li-ion Batteries charging. Having LCD Display for Battery Charging Status & Micro USB Port for Charging Input & Type C Port for external Device charging. You can charge Batteries with USB Adapter, Power Bank, Laptop or Car USB Port which ever mode is available . Over Voltage, Over Current or Short Circuit protection keeps your Battery & Charger both Safe.

Specifications:

Input Voltage	: 5V 2.1A (Micro USB Port)
Battery Charging Current	: Channel 1 - 700 ± 60mA Channel 2 - 700 ±60mA
Output	: 8.4V
Charging Status	: LCD Indicator
Operating Temperature	: 0°~35°
Dimension	: 90 x 56.2 x 24 mm
Weight	: 30 gms

Available Model for Available Model for ENEL-14, NP-FW-50, LP-E10, LP-E6, LP E17 Hero 5/6/7/8 & 9.



Micro USB Port for Charging

Li-ion Battery LCD Charger

DPUC-012S

for EN-EL15 Li-ion Battery

Digitek DPUC-012 S is a Lightweight & Compact Li-ion Batteries LCD Charger for EN-EL15 Li-ion Battery. LCD Display for Charging Status & with Micro USB input port. Most useful when on the go, it Can be charge through USB Adapter, Power Bank, Laptop or Car USB Port which ever mode is available . Over Voltage, Over Current or Short Circuit protection keeps your Battery & Charger both Safe.

Specifications:

Input Voltage	: 5V (Micro USB Port)
Battery Charging Current	: 600mA
Charging Status	: LCD Indicator
Operating Temperature	: 0°~35°
Dimension	: 83.5 x 51 x 17.6 mm
Weight	: 30 gms

Available Model for ENEL-15, FW-50, LP-E10 & LP-E6

Li-ion Battery Charger

DPUC-011

for Hero 5 / 6 / 7 / 2018 Black



Multi Li-ion Battery Charger DPUC-011, Light Weight & Small 3-Channel LED USB Charger with Micro USB & Type-C Input. Compatible with HERO 7, HERO 6, HERO 5, HERO 2018 Black Newest firmware v01.50, v01.55, v01.57 and v02.00, v02.51, v02.60. With Micro USB & Type-C ports. It can be connected to a Wall Charger, Car Charger, Power Bank or even a solar charger. No need to ever worry about being out of power. LED indication for Charging Status. While charging battery LED will be Red & turn Green when fully charged. Controlled by MCU & Pulse Charging technology to protect the charger & battery.

Specifications:

Applications	: Li-ion Battery
Input	: Micro/Type C 2.1 A
Output	: Channel-1. DC4.4V / 700mA, Channel-2. DC4.4V / 700mA Channel-3. DC4.4V / 700mA, DC4.4V / 600mA (3 Batteries at a time)
Color	: Black

Multiple way to charging Input



Multi Li-ion Battery Charger & 2 Camera Batteries Combo

DPUC-010

Platinum Li-ion Battery Charger DPUC-010 can charge Li-ion Camera Batteries. Can Charge Two batteries at a time. The charging is controlled by MCU & the charging control is accurate.

Specifications:

Model No.	: DPUC-010
Applications	: Li-ion Battery
Input	: Micro USB 5V / 2A
Input Power	: 10W (Maximum)
Output	: DC 8.4V 800mA x 1 / 550mA x 2
Working Temperature	: 00C-400C
Color	: Black
Certifications	: CE, RoHS, BIS
Available Combos	: For Nikon EN-EL14, EN-EL15, For Canon LP-E6 Platinum For Sony FW-50 Platinum ,FZ-100



Multi Li-ion LCD Battery Charger

DUC-008

Multi Li-ion Battery Charger DUC-008, conveniently charges two batteries simultaneously with two interchangeable plates. The Intelligent charger features an LCD Display that graphically shows charging status for both batteries. This allows you to test batteries instantaneously, so you can easily decide which Li-ion cells to bring with you for the day. With protection against over charging, overheating & short circuit, the DUC-008 charger safely conveniently, quickly recharges tow compatible Li-ion Batteries.

Specifications:

Input Voltage	: AC 100-240V, 800mA 50/60Hz
Battery Charging Current	: DC 8.4V 200mA x 1, 1000mA x 2
Charging Status	: LCD Indicator
Available Model	: For all Sony, Panasonic, Canon, Nikon
Operating Temperature	: 0°~40°
Certifications	: CE, RoHS, BIS
Dimension	: 112 x 12 x 40 mm
Weight	: 240 gms
Available models	: For all Sony, Panasonic, Canon, Nikon, Fuji etc. Professional Cameras.



Li-ion Battery Travel Charger

DUC-006

Digitek DUC 006 Charger supports charging of Lithium Ion rechargeable batteries. DUC006 charger features Indian plug. Ideal for travel worldwide with operational voltage range of 100-240 volts. Empowered with quick charge technology, it can charge Camera/DSLR/Video Camera batteries 1.5X faster than regular chargers. DUC-006 Charger is equipped with Auto Charge Cut to prevent over charging and over heating once completely charged.

Specifications:

Applications	: Li-ion Battery
Input	: AC-100-240V/ 50/60Hz max 150mA
Output	: DC 8.4V 600mA
Color	: White
Working Temperature	: 00C-400C
LED Indicator	: LED glows Red while charging & turn Green when fully charged.
Available models	: For all Sony, Panasonic, Canon, Nikon Fuji etc. Professional Cameras.

RANGE OF
NI-MH / NI-CD / Li-Ion
 RECHARGEABLE BATTERIES / CHARGERS

envie[®]
 INTELLIGENT POWER SOLUTIONS

SprintX



**ECR-11MC
 AA/AAA
 Charger**

1. Can charge 1-4pcs of AA/AAA Ni-MH/Ni-Cd rechargeable batteries & with LCD Battery Display
2. Charging by IC control, with -V intelligent Cut Off the rapid charging function, automatic transfer to Trickle-Charging, ensure the battery can be fully charged and not overcharged.
3. There is a letter "CHG" showing on LCD after battery loaded.
4. Constant Current charging for longer battery life & Auto Cut-Off charging. Ensure Safety usage.

SPEEDSTER



**ECR 11
 AA/AAA
 Charger**

1. This charger can charge AA/AAA Ni-MH/Ni-Cd rechargeable Batteries.
2. Individual charging slot, charges 1/2/3/4 AA/AAA sizes at a time
3. Super Quick Charger, charges 2100mAh in just 1.2 Hours.
4. Desktop Charger with Indian Plug & LCD Display.
5. Constant Current charging for longer battery life & Auto Cut-Off charging. Ensure Safety usage.

COOPER



**ECR-20MC
 AA/AAA
 Charger**

1. Can charge 1/2/3/4 pcs of AA/AAA Ni-MH/Ni-Cd Rechargeable Batteries.
2. LED shows the charging process of its corresponding charging slot, but will not turn off when fully charged.
3. The charger would not charge the batteries loaded with wrong polarity or dry one.
4. Constant charging current & voltage keep the battery life longer.
5. Protection against overheat & over current.

NEXA



**ECR-30
 AA/AAA/9V
 Charger**

1. Can charge 2 or 4pcs AA/AAA or 1-2 pcs 9V Ni-MH / Ni-CD Rechargeable Batteries.
2. The Red LED will show the charging process of its corresponding charging slot, but will not Turn Off when fully charged.
3. The charger would not charge the batteries loaded with wrong Polarity or Dry cells.
4. Constant charging Current & Voltage keep the Batteries Life Longer.
5. Protection against Overheat and Over current.

B.e.e.t.t.e



**ECR 20
 Battery
 Charger**

1. Charge 2 or 4 pcs AA/AA Ni MH/Ni-Cd batteries.
2. Two LED's show the charging process of its corresponding charging slot, but will not turn off when fully charged.
3. The charger would not charge the batteries loaded with wrong polarity or dry one.
4. Constant charging current and voltage keep the battery life longer.



**9V
 Ni-MH
 300mAh**

- Infinite 9 Volt Rechargeable Ni-MH Battery is an Ready to Use & Rechargeable battery. You can use it straight from the pack. No need to charge before use.
1. 300mAh / 9V Li-ion battery with Micro USB charging port.
 2. Can charge by Micro USB Cable with Wall Adaptor, Car Charger or Power Bank via the Micro USB port.



**AA
 Ni-Cd
 1000mAh**

- Functional design: Set of 4 International Standard universally compatible Rechargeable Ni-Cd batteries
- Capacity** : Best in Industry 1000mAh with 500+ charge cycles & no memory effect.
- No Memory effect & Low Self Discharge**



**9V MU
 Li-ion
 800mAh**

- Infinite Plus 9 Volt MU Rechargeable LI-ion Battery is an Ready to Use & Rechargeable battery. You can use it straight from the pack. No need to charge before use.
1. 800mAh / 9V Li-ion battery with Micro USB charging port.
 2. Can charge by Micro USB Cable with Wall Adaptor, Car Charger or Power Bank via the Micro USB port.



**AA
 2800mAh
 RTU**

Infinite Plus AA 2800mAh Ready to Use - Rechargeable
 Functional design: Set of 4 universally compatible Ready to Use - Rechargeable Ni-MH AA Batteries which can be used straight from the pack without initial charging.

Capacity : Best in Industry 2800mAh with 1200+ charge cycles & no memory effect.

Low Self Discharge : Remain charged upto 80% for 12 months without use.



**AA
 2100mAh
 RTU**

Infinite AA 2100 is an Ready to Use & Rechargeable **Low Self discharge Ni-MH** Battery. You can use it straight from the pack. No need to charge before use.

Capacity : 2100mAh Ni-MH with 1200+ Charge Cycle. & No Memory Effect.

2. Low Self Discharge Rate : Remain Charged up to 80% for 12 Months without use.



**AAA
 1100mAh
 RTU**

Infinite Plus AAA 1100mAh is an Ready to Use & Rechargeable **Low Self discharge Ni-MH** Battery. You can use it straight from the pack. No need to charge before use.

Capacity : 1100mAh Ni-MH with 1200+ Charge Cycle. & No Memory Effect.

2. Low Self Discharge Rate : Remain Charged up to 80% for 12 Months without use.



**AAA
 800mAh
 RTU**

Infinite AAA 800mAh is an Ready to Use & Rechargeable **Low Self discharge Ni-MH** Battery. You can use it straight from the pack. No need to charge before use.

Capacity : 800mAh Ni-MH with 1200+ Charge Cycle. & No Memory Effect.

2. Low Self Discharge Rate : Remain Charged up to 80% for 12 Months without use.



IMS Mercantiles Pvt. Ltd.

Corporate Office : 704, Ring Road Mall, Near Deepali Chowk, Sector -3, Rohini, Delhi-110085
Toll Free - 1800 123 544 444 | support@digitek.net.in | www.digitek.net.in