

# FAHRBIKE

[www.fahrbike.com](http://www.fahrbike.com)



**OWNER'S MANUAL  
FAHRBIKE-CRUZ**

# Contents

<b>Introduction</b> .....	01	<b>LCD Display</b> .....	15
<b>Safety Check</b> .....	02	Switch Power ON / OFF .....	15
<b>General Information</b> .....	04	Power Assist Level .....	15
Disclaimer .....	04	Throttle and Cruise Control .....	15
<b>Product Specification</b> .....	05	Headlight and Taillight .....	16
<b>Assembly</b> .....	07	Walk Mode .....	16
Handlebars .....	07	Data Mode .....	16
Front Wheel .....	08	Settings Mode .....	17
Rear Wheel .....	09	Error Code Definition .....	18
Tire Pressure .....	09	<b>Maintenance</b> .....	19
Fender .....	09	Cleaning .....	19
Pedals .....	10	Tips .....	20
Seat .....	11	<b>Legal Requirements</b> .....	21
Bottle Holder .....	11	Serial Number .....	21
Brake Lever Adjustment .....	11	<b>Warranty</b> .....	22
Removing the Battery .....	12		
<b>Battery Care</b> .....	13		
Battery Charging .....	13		
Battery Storage .....	14		

# Introduction

Congratulations on the purchase of your Fahrbike! You have chosen a bike that will give you an unparalleled riding experience and you have made a wise choice.

Please read this Owner's Manual carefully before using your new e-bike. It is your reference for assembly, maintenance, and safety.

If you are not confident in assembling the bike yourself, we strongly recommend that you have your bike assembled by a qualified bicycle mechanic.

If you have questions or need assistance, please contact us directly.

Official Website: [www.fahrbike.com](http://www.fahrbike.com)

Email: [service@fahrbike.com](mailto:service@fahrbike.com)

# 1

# Safety Check

---

Please check the following components: Handlebars, stem, pedals, crank arms, and wheels. Make sure they are properly assembled and tightened. Even if some of the components are pre-assembled, each part must be tightened to the specified torque. If you do not notice a loose component, it may come loose during use and cause serious injury.

- **Wheels:** An important part of assembling your bike is attaching the front and rear wheels and checking that the wheel axle nuts are tight. Properly assembled wheels are essential for the safe use of the bicycle.
- **Tires:** Both tires must be inflated according to the specifications in the manual. Failure to do so will reduce performance, increase tire wear, and compromise your safety.
- **Crank and pedals:** Make sure the crank arms and pedals are tightened to the specified torque. A required tool for the crank: 8 mm hex key, recommended tightening torque 30-35 Nm. Required tool for the pedals: 15 mm wrench, recommended torque 35-40 Nm.
- **Brakes:** Make sure the brakes are working properly and are properly secured. When braking, apply the rear brake first, then the front brake. Incorrect application of the brakes can result in serious injury.
- **Throttle:** The throttle mechanism can be used to partially or fully activate the engine power. Inexperienced users should be a bit more careful when operating the throttle for the first time. The throttle function is deactivated when the pedal assistance is set to "0".

It is recommended that the above safety checks be performed every 200 - 300 km (120 - 180 miles) or when the bicycle has not been used for three weeks.



## For Your Safety

Users must familiarize themselves with the power controls before riding. It is strongly recommended that you ride your new bike in an open area and set the assist level to "0". Once you become accustomed to operating your bike, gradually increase the assistance level.

It is good practice to keep your hands over the brake levers. The brake levers are equipped with motor protectors that shut off motor power when activated. If you lose control for any reason, immediately apply the brake levers to shut off motor power. Do not attempt to stop your bike with your feet as this may cause you to lose your balance.

When walking or carrying your bike, turn off the power to avoid accidentally turning on the motor. If the motor is accidentally turned on, immediately apply the brakes to cut the power to the motor.

# 2

# General Information

---

## Disclaimer

The use of an e-bike involves risks, and it is the user's responsibility to understand those risks. You are responsible for your own actions when using an electric bike. Fahrbike is not responsible or liable for any accidents or injuries (whether caused by you or others) that may occur during use. We recommend that you contact your insurance company to find out whether or not your current insurance policy covers you in the event of an accident.

## 3

# Product Specification

<b>Battery</b>	48V, 720Wh	<b>Front Fork</b>	SR Suntour with Lockout
<b>Motor</b>	500W Geared Brushless Motor	<b>Bike Frame</b>	Step-through 6061 Aluminum Alloy Frame
<b>Display</b>	LCD Display	<b>Brake</b>	Hydraulic Disc Brakes, 180mm Rotors
<b>Speed</b>	24MPH	<b>Freewheel</b>	Nickel Plated 11-32T 8-speed
<b>Pedal</b>	Wellgo Aluminum Platform	<b>Shifter</b>	Shimano Rapid Fire Plus 8-Speed
<b>Crankset</b>	42T Single Guard	<b>Tires</b>	27.5" x 2.1" Kenda Tire
<b>Recommended Rider Heights</b>	Available in 15" /17" /19" Sizes for Riders 4'11" to 6'2" Tall	<b>Product Weight</b>	65 lbs



# 4

# Assembly

**(A) Handlebars** (required tools: 4mm hex key, 5mm hex key)

- Unscrew the retainer from the head tube.
- Remove the silver spacers from the head tube.
- Insert the handlebar stem into the head tube.
- Fold the handlebar by opening the lever.
- Insert the retainer into the head tube and tighten (recommended tightening torque 8 Nm).
- Unfold the handlebar by closing the lever.
- Align the handlebar with the front wheel and tighten the two bolts on the side of the stem (recommended tightening torque 12 Nm).

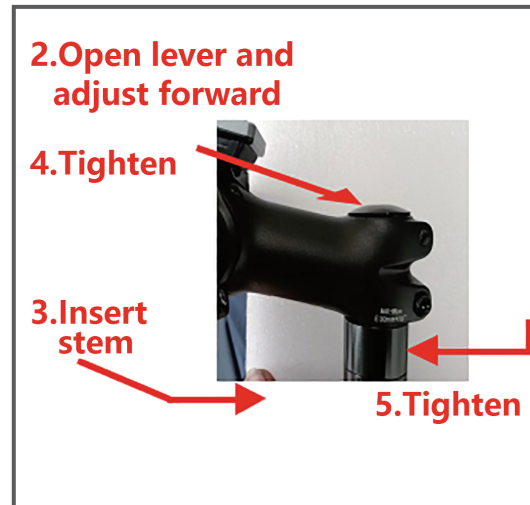

**(B)Front Wheel**

- Remove the brake pad protector between the brake pads.
- Install the wheel by sliding the disk brake rotor between the brake pads and inserting the fork end onto the wheel axle.
- Remove the nut and spring (A) from the quick-release skewer.
- Insert the quick release skewer with spring (B) pointing inward into the right side of the wheel axle.
- Insert spring (A) pointing inward into the left side of the quick release skewer and tighten the nut.
- Close the quick release lever and tighten it by turning clockwise.

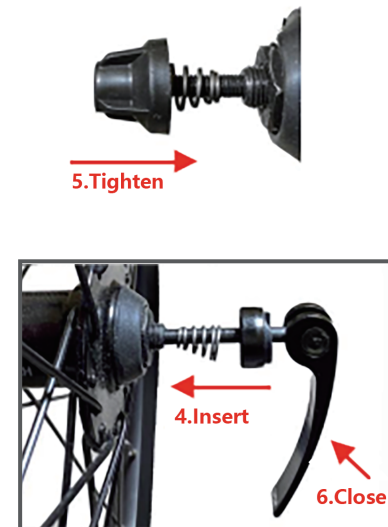
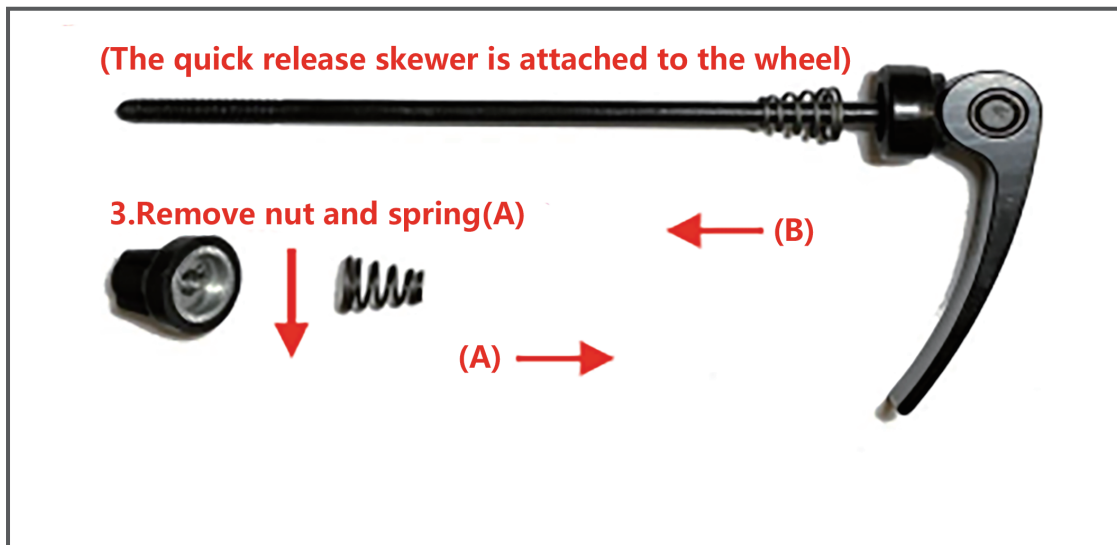

**(C)Rear Wheel** (required tools: 18mm wrench, recommended torque 40 N.m)

Ensure the rear wheel is tightened at the recommended torque value.

**(D)Tire Pressure**

The recommended tire pressure is 40-65 psi. The tire pressure range depends on many variables. So please consider your weight, your load, the terrain, the temperature, the feeling of traction you have while driving, and slopes if applicable.

**⚠ WARNING**

The tires must be inflated with the air pressure indicated on the tire sidewall. The tires must not be overinflated or underinflated.

**(E)Fender** (required tools: 4mm hex key, 5mm hex key, 10mm wrench)

- Place the fender hook on the front side of the fork arch at the highest position.
- Insert the bolt into the headlight holder and fender hook, and tighten on the fork arch.
- Use the bolts mounted on the fork to tighten the fender stays.

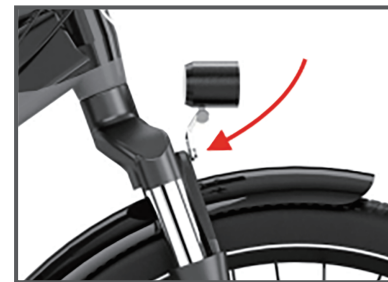

**(F) Pedals** (required tools: 15mm wrench, recommended torque 35-40 Nm)

The right and left pedals are marked with an "R" or "L" at the end of the thread. The right pedal axle has a smooth surface, while the left pedal axle has grooves.

The pedal and crank threads are designed to engage easily. Tighten the pedals by hand first. It should be easy for the first few turns. Do not force the pedals if tightening is difficult. If tightening is difficult, stop immediately as the pedal thread is not aligned, and continuing to tighten will damage the crank arm thread.

- Apply a small amount of grease to the pedal axle.
- Insert the right pedal into the right crank arm. Carefully and slowly turn the pedal clockwise by hand onto the crank and then tighten it completely.
- Insert the left pedal into the left crank arm. Carefully and slowly turn the pedal counterclockwise by hand onto the crank and then pull it completely tight.

 **WARNING**

Inserting the pedal in the wrong way, installing it at the wrong angle, or improper tightening will strip the crank arm threads and cause the pedal to come off.



**(G)Seat**

- Open the seat tube lever, insert the seat post, and close the lever to lock.
- Rotate the lever to adjust the lock tightness.
- Adjust the seat angle by loosening the bolt underneath the seat. You can tilt the seat up or down and move it forward or backward to fit your comfort (required tools: 5mm hex key, recommended torque 25 Nm).



<b>⚠ WARNING</b>	
	<p>Do not raise the seat post beyond the minimum insertion point line. Doing so may cause the seat post or frame to break and can result in serious injury or death.</p>

**(H) Bottle Holder** (optional)

Use the screws mounted on the frame tube seat to install the bottle holder.

**(I) Hydraulic Brake Lever Adjustment** (required tools: 2mm hex key)

- Tighten the indicated bolt to extend the brake lever reach.
- Loosen the indicated bolt to shorten the brake lever reach.

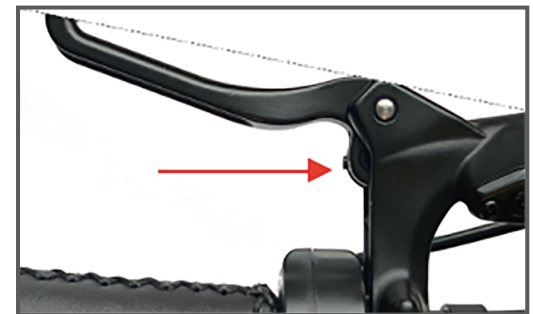

## (J)Removing the Battery

The battery keys are attached to the handlebars. Insert the key into the keyhole, turn it clockwise, turn the battery up and pull.

### **WARNING**



Failure to observe assembly, operation, and/or maintenance can result in serious injury.

## Battery Charging

Make sure the battery is fully charged before the first ride. Connect the charger to the battery first and then to the power outlet. The charger will show a red light to indicate that the battery is charging. Once the battery is fully charged, the indicator will turn green.

Remove the charger from the battery when it is fully charged. The charger will automatically stop charging when the battery is full. However, unnecessary damage to the charging components may occur if the charger remains connected to the battery and power source.

The battery can be recharged after each use. Charging the battery after short trips will not cause any damage.

- Charge the battery on a non-flammable surface and near a smoke or fire detector. Do not charge the battery in a wet/damp place or a place exposed to strong sunlight.
- Always charge the battery at temperatures between 10 and 25 °C.
- Charge the battery using the supplied charger. Do not attempt to use any other charger as this may damage the battery or cause a fire or explosion.
- Do not leave the battery unattended while charging.

 **WARNING**

Failure to follow proper charging procedures may result in damage to your battery, charger, and other personal property.

## Battery Storage

- Keep the battery indoors during extreme weather.
- Avoid storing the battery in places of high temperature or high humidity.
- Charge the battery to 70% if not used for two months. The battery will slowly discharge over time. When the battery reaches 20% charge it again to 70%.

# 6

# LCD Display

## Switching the Power ON / OFF

- Press and hold the power button for two seconds. The LCD turns on and the bike is ready to start.
- To switch off, press and hold the power button for two seconds.

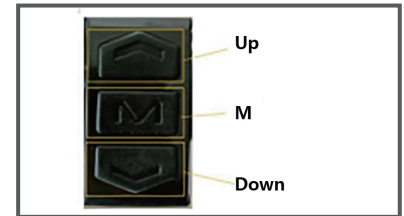

## Power Assist Level

- The assistance level determines the power of the motor when pedaling.
- There are 1-5 assistance levels, with 1 being the lowest and 5 being the highest. If you want to ride without motor assistance, select 0.
- Press the + (up) / - (down) button to select the assistance level.

## Throttle (Accelerator) and Cruise Control

- The throttle is activated as soon as the LCD display is turned on. If you want to switch off the throttle, and select support level "0" .
- To activate cruise control, see LCD advanced settings (option 19).

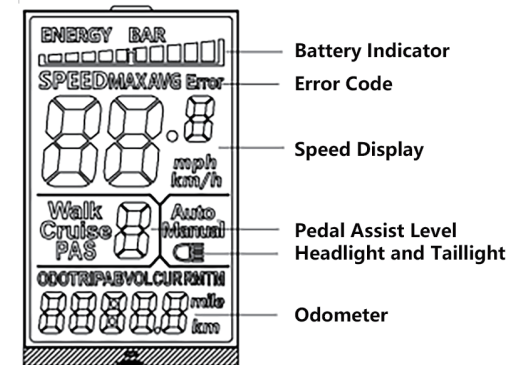

## Switching ON / OFF the Headlight, Taillight Mode

- Press and hold the + (up) button for one second to switch on the lights.
- Press and hold the + (up) button again to switch off the lights.

## Walk Mode

Press and hold the - (down) key to start the walk mode. This function runs the motor at a relatively low speed to help you walk the bike.

## Data Mode

- Press the M key briefly to change the data mode display. Press again to change to the next mode. The sequence of modes:  
Odometer > Single trip > Current voltage > Current running > Time
- Press the M and + buttons briefly to change the data mode display. Press again to change to the next mode. The sequence of modes:  
Average speed > Maximum speed

## Settings Mode

- Press + (up) and - (down) to enter the settings mode.
- Press the M button to navigate through the settings options.
- Press + (up) or (down) buttons to make changes.
- To exit the settings mode, press + (up) and - (down).

If there is no action for 8 seconds in settings mode, you will be returned to the home screen.

- P01: Backlight brightness (1: darkest; 3: brightest)
- P02: Mileage units (0: Km; 1: Miles)
- P03: Voltage class 24V / 36V / 48V / 52V
- P04: Sleep interval (0: never, other value means show sleep interval;1-60 minutes) Unit: minute
- P06: Wheel Diameter Unit: inch

Wheel diameter (16, 20, 24, 26, 27.5) (20F, 26F - for 4" fat tires)

The wheel diameter must be set according to the tire size. Wrong tire size will cause inaccuracy in the speed and distance readout.

- P08: Speed limit (default 32 km / 20 miles)  
Set the maximum speed limit. 41=No speed limit
- P12: Motor responsiveness (default 2)  
Enables you to adjust motor responsiveness from 0 - 3 (gradual to quick response).

- P15: undervoltage (mating controller)
- P16: ODO Zero-Out  
Long press the up key for 5 seconds and the ODO value will be erased.
- P19: Cruise control (0 disabled, 1 enabled)  
To start the cruise control, push and hold the throttle at the desired speed for 10 seconds, without pedaling.

## Error Code Definition

When an error is detected, the display LCD will show an error code.

The error codes range from:

- Error 01: Controller overheating
- Error 07: Motor phase lost
- Error 22: Throttle error
- Error 24: Motor hall error
- Error 30: Controller communication error



It is important to properly maintain your bicycle and tune it regularly to ensure optimal performance and safe riding. Regularly lubricate your chain, gears, sprocket, and all moving parts.

Before each ride, check the condition of your bike and make sure it is well maintained. If in doubt, consult a bicycle mechanic.

## WARNING



If you do not have the experience, skill, or tools necessary to service your bicycle, we strongly recommend that you hire a qualified bicycle mechanic to do the work for you.

## Cleaning

- Wipe your bike after every wet ride & store it in a dry place to avoid rust and corrosion.
- Always remove the battery when cleaning or servicing your bike.
- Clean the battery and battery case with a slightly damp cloth as needed. Do not spray with water as this may damage the battery or cause a short circuit.

## Tips

- Check tire pressure regularly and make sure tires are inflated with the correct amount of air.
- Lubricate your chain regularly (every 160 km). Use a special bicycle lubricant to maximize performance and ensure a smoother ride.
- Park your bike indoors when wet. Proper maintenance is necessary to ensure that all electrical systems are working properly and to prevent your bike from rusting and corroding.
- Avoid transporting your bicycle on a rack when it is raining, as this can allow water to enter the electrical components.

# 8

# Legal Requirement

---

Electric bikes are regulated, and regulations vary by country, state, or city. It is your responsibility to learn about and comply with local laws. You can contact local authorities, electric bicycle stores, or bicycle associations for more information about the legal requirements.

For your own safety, you are required to wear a helmet. Use front and rear lights after sunset to be seen better.

## Serial Number

It is important to keep your serial number as it will be required by the police in the event of theft. Fahrbike does not keep the serial numbers of the bikes it sells. The serial number is located on the bottom of the frame at the bottom bracket (pedals) and is in the form of a bar code. It is your sole responsibility to record the serial number upon receipt of the bike.

Fahrbike e-bikes are built with sturdy frames and high-quality parts from solid brand manufacturers. Each e-bike comes with a 12-month warranty against defects from the manufacturer.

## **What is a claim for shipping damage?**

Please inspect the package when you receive your order. If you notice any damage to the package, please take photos. This is to support any claims if the product has been damaged inside and to prove that the damage is due to shipping.

## **What is an out-of-the-box defect policy?**

With our out-of-the-box defect policy, we guarantee that you will receive a working bike. If your bike is damaged or does not work, we will cover the cost of repairs to get your bike back in working order.

Claims of out-of-the-box defects must be reported within 2 weeks of receipt of the bicycle and after no more than 5 kilometers (3 miles) of use.

Any defects claimed after the specified time or distance are not covered by the term "out-of-the-box defects". However, this does not affect the validity of the 12-month warranty.

## What does the 12-month warranty include?

The 12 months start on the day you receive your bike, not the day you buy it. The warranty covers all manufacturer defects on the main frame of the bike. The warranty also covers any electrical defects that may occur during normal use. If an electrical component stops working or does not perform as expected, we will work with you to repair or replace the faulty part. This also covers the cost of shipping and handling.

Fahrbike will only cover work or services performed at Fahrbike authorized repair shops. Work performed at workshops not authorized by Fahrbike will not be covered.

If our warranty team determines that the defect is due to rider/owner abuse or negligence, the part will not be covered under warranty.

## How easy is it to repair a Fahrbike e-bike?

Our bikes are designed to be easy to maintain and repair. All troubleshooting information is available in the documentation and video format. If you need our help, we will be happy to help you in any way we can.

Please note that all mechanical parts require regular overhaul and maintenance. If you maintain your bike regularly, you will improve the reliability and operation of your bike.

## What are the electrical components?

- LCD Screen & Button Pad
- Throttle
- Brake Inhibitors
- Main Cable Wire
- Controller
- Pedal Assist Sensor
- Speed Sensor
- Motor
- Battery and Stand
- Front and Rear Lights

## What is not covered by the warranty?

- Mechanical components include the braking system, suspension, seat, luggage rack, wheels, and rims.
- Normal wear and tear from general use.
- Corrosion or damage due to improper storage.
- Damage resulting from the improper assembly of the bike.
- Damage or failure resulting from misuse, neglect, lack of maintenance, improper use, or accidents.
- Damage resulting from improper charging of the battery or use of a charger not supplied by Fahrbike.
- Cosmetic damage caused by use.



4. Tighten



## What voids the Fahrbike warranty?

The installation of electrical components not supplied by Fahrbike. In some cases, the installation of mechanical components not supplied by Fahrbike may cause damage to electrical components. If this is the case, the warranty will not cover the damage.

## How can I make a warranty claim?

First of all, we recommend you to search our knowledge base for the most frequently asked questions and answers, as you will most likely find the solution to your problem there.

If you could not find what you were looking for, make sure you include the following in your email:

- Full name
- Order number
- Bike model
- Please include a detailed description of your complaint, including a description of the situation before the problem was noticed, and include photos and videos to further illustrate the problem.
- Contact detail



---

If you have any other questions, please refer to the Fahrbike Help Center.

Official Website: [www.fahrbike.com](http://www.fahrbike.com)

Email: [service@fahrbike.com](mailto:service@fahrbike.com).

This owner's manual is subject to change without notice  
Please visit **[www.fahrbike.com](http://www.fahrbike.com)** to download the latest version.

---