

Lithium Iron Phosphate (LiFePO₄) Battery

MODEL: TN-LFP12.8V12AH

GENERAL SPECIFICATIONS

ELECTRICAL CHARACTERISTICS	
Nominal Voltage	12.8V
Nominal Capacity	12Ah@0.2C
Energy 1075.2Wh	153.6Wh
Internal Resistance	70≤mΩ
Cycle Life	>2000 Cycles @ 0.2C Charge/Discharge at 100%DOD, End of Life 70% Capacity.
Self Discharge ≤3.5% per month at 25°C	≤3.5% per month at 25°C

STANDARD DISCHARGING	
Discharging Current	2.4A
Max. Continuous Current	12A
Max Pulse Current	30A(<3S)
Discharging Cut-off Voltage	10.0V

STANDARD CHARGING	
Charging Voltage	14.6±0.2V
Charging Mode (CC/CV)	At 0°C~45°C temperature, charged to 14.6V at a constant current of 0.2C5A, and then, changed continuously with constant voltage of 14.6V until the current was not more than 0.02C5A
Charging Current	2.4A
Max Charging	6A

MECHANICAL	
Cell & Format	IFR32700 N60,4S2P
Casing	ABS
Dimension(L*W*H*TH)	151*98*95*101mm
Weight Approx.	1.55Kg
Terminal	F2

ELECTRICAL CHARACTERISTICS	
Charge Temperature	0°C to 45°C (32°F to 113°F) @60±25% Relative Humidity
Discharge Temperature	-20°C to 60°C (-4°F to 140°F) @60±25% Relative Humidity
Storage Temperature	0°C to 45°C (32°F to 113°F) @60±25% Relative Humidity
Water Dust Resistance	IP55



FEATURES

- Using lithium iron phosphate technology, superior safety, thousands of cycles, 100% DOD, under normal conditions
- Built-in automatic protection for over-charge, over discharge, over current and over temperature
- Maintenance free
- Internal cell balancing
- Lighter weight: About 40% ~50% of the weight of a comparable lead acid battery.
- Can be charged using most standard lead-acid charges (set)
- Wider temperature range: -20°C~60°C

APPLICATION

- Recreational Vehicles
- Marine
- Renewable Energy
- Medical / Mobility
- Electric Vehicles
- Golf Cart

DIMENSIONAL SPECIFICATIONS

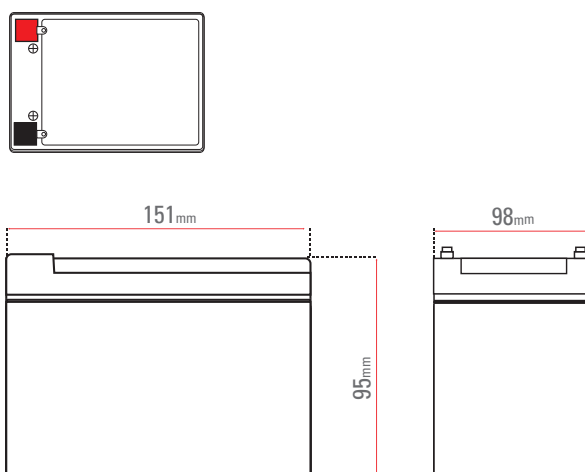

Lithium Iron Phosphate (LiFePO4) Battery | MODEL: TN-LFP12.8V12AH

Different Rate Discharge Curve @ 25°C

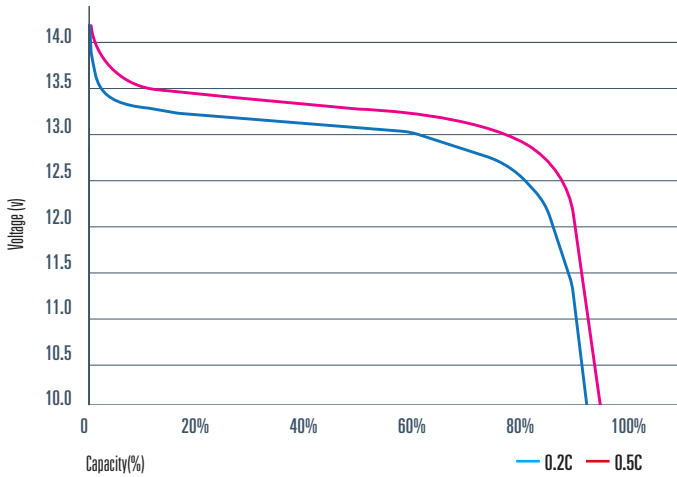

Charge Characteristics @0.2C&0.5C, 25°C

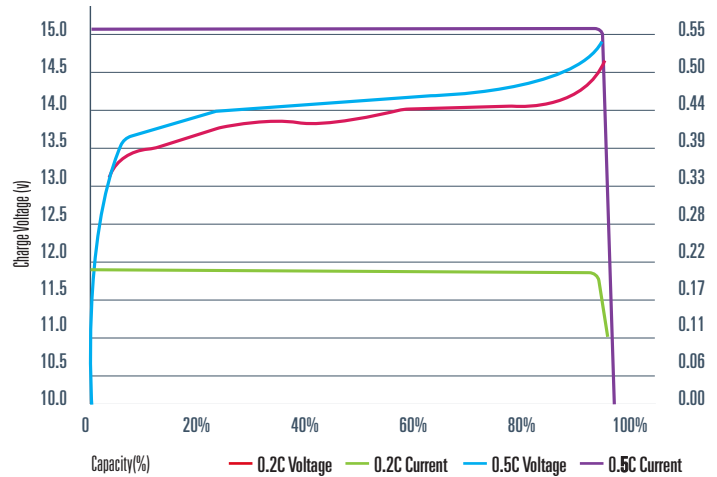

Different Temperature Discharge Curve @0.5C, 25°C

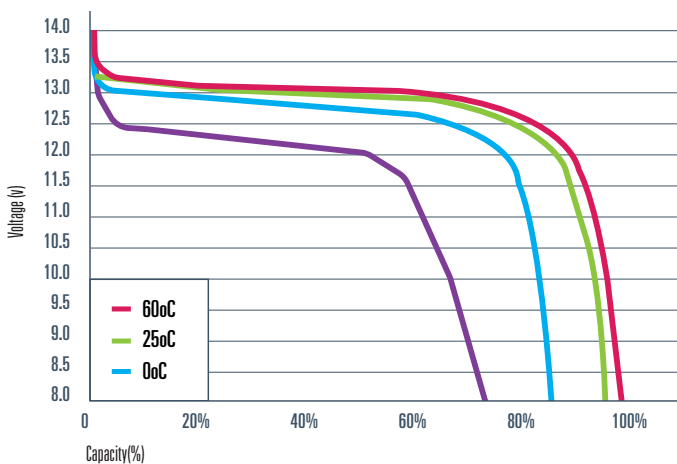

Charge Characteristics @0.2C&0.5C, 25°C

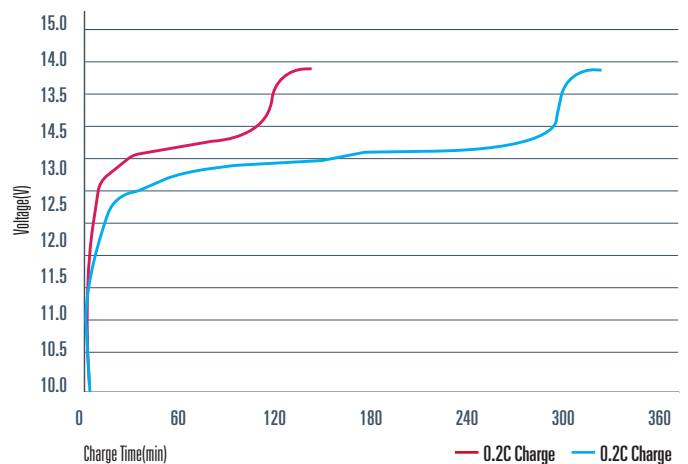

Different DOD Discharge Cycle Life Curve @0.5C, 25°C

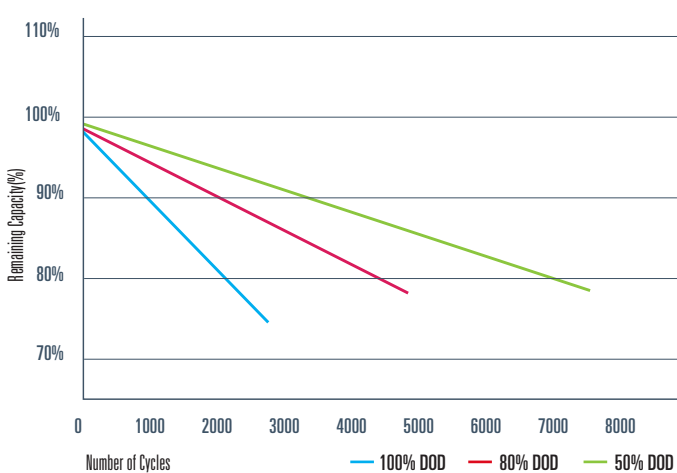

Open circuit voltage VS SOC%

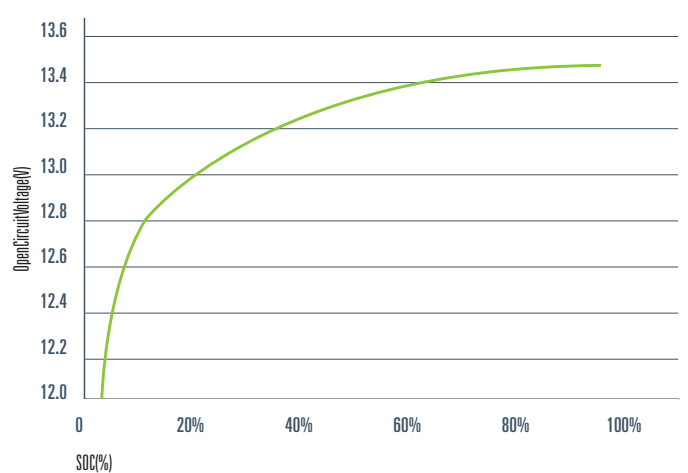

TN POWER Lithium is UN38.3 certified

