

# MONITORING SCREEN

FOR SMART LITHIUM BATTERY SERIES



Version 1.1



## **Important Safety Instructions**

**Please save these instructions.**

This manual contains important installation and operation instructions for your Renogy monitoring screen. Please review and observe these instructions and keep them located near the monitoring screen for further reference. The following symbols are used throughout the manual to indicate potentially dangerous conditions or important safety information.

**WARNING**

Indicates a potentially dangerous condition. Use extreme caution when performing this task.

**CAUTION**

Indicates a critical procedure for the safe and proper installation and operation of the monitoring screen.

**NOTE**

Indicates a procedure or function that is important to the safe and proper installation and operation of the monitoring screen.

### ■ **Disclaimer**

The manufacturer accepts no liability for any damage caused by:

- Force majeure including fire, typhoon, flood, earthquake, war, and terrorism.
- Intentional or accidental misuse, abuse, neglect or improper maintenance, and use under abnormal conditions.
- Improper installation, improper operation, and malfunction of a peripheral device.
- Contamination with hazardous substances, diseases, vermin, or radiation.
- Alterations to the product without express written consent from the manufacturer.

---

## ■ General Safety Information

### WARNING

- Any uncovered battery material, such as electrolyte or powder, that has contacted skin or the eyes must be flushed out with plenty of clean water immediately. Seek medical attention afterwards. Spillages on clothing should be rinsed out with water.
- DO NOT touch the exposed electrolyte or powder if the battery casing is damaged.
- Please make sure any battery charger(s) or charge controller (s) are disconnected when working on the battery.
- DO NOT connect or disconnect terminals from the battery without first disconnecting loads.
- DO NOT wear jewelry or other metal objects when working on or around the battery.
- DO NOT place tools on top of the battery.
- Please keep the battery out of the reach of young children.
- Please wear proper protective equipment when working on the battery.
- Please use insulated tools when working on battery.
- DO NOT attempt installation while using alcohol or medication that could impair judgement and/or reaction time.

- 
- If installing in an engine compartment with a gasoline engine, proper ventilation practices must be used to ensure no explosive gases are present before installation.
  - If installing in a compartment with batteries, the compartment must be properly ventilated to ensure no build-up of explosive gases prior to installation.

**CAUTION**

- Your Renogy monitoring screen is designed for indoor/compartment installation. DO NOT expose it to direct sunlight, rain, snow, moisture, or liquids of any type.
- DO NOT puncture, drop, crush, burn, penetrate, or strike the monitoring screen.
- DO NOT open, dismantle, or modify the monitoring screen.
- The Renogy monitoring screen is only compatible with Renogy Smart Lithium Iron Phosphate Batteries. DO NOT attempt to connect the monitoring screen to other batteries or systems.

# Table of Contents

Important Safety Instructions .....	01
General Information .....	05
Product Overview .....	06
Identification of Parts .....	06
Dimensions .....	07
Installation .....	08
Operation .....	15
LCD Information .....	15
Button Operation .....	19
Troubleshooting .....	20
Technical Specifications .....	21

## General Information

The Renogy Monitoring Screen for Smart Lithium Battery Series is a high precision meter designed for Smart Lithium Iron Phosphate Batteries in off-grid energy storage systems. Instead of measuring the current flowing in/out of the battery bank, it can communicate directly with the battery management system (BMS) and obtain more accurate state of charge (SoC) readings compared to traditional battery monitors. Other battery bank information including voltage, current, capacity, remaining time, error code, and number of paralleled batteries are also available on the monitoring screen to help users avoid abnormal conditions and extend the lifetime of battery bank.

### Key Features

- **Plug and Play**

Simply connect the monitoring screen to the battery bank using an RJ45 communication cable for real-time monitoring.

- **Accurate Readings**

Obtains battery bank status directly from the battery management system for precise tracking and prediction.

- **Comprehensive Protection**

Displays straightforward error codes for the quick recognition of potential abnormal conditions and improper operation.

- **Easy Operation**

Shows detailed battery bank information at the push of a button without the need of system configuration and calibration.

# Product Overview

## ■ Identification of Parts

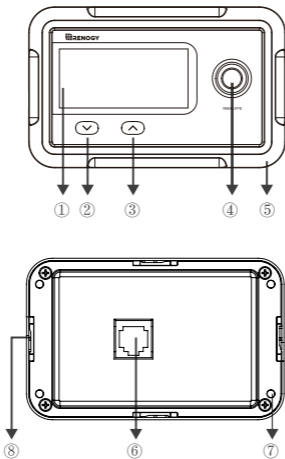

① LCD Screen

② Page Down Button

③ Page Up Button

④ Power Button

⑤ Front Cover Plate

⑥ RJ45 Communication Port

⑦ Mounting Holes

⑧ Snap-fit Joints

## Dimensions

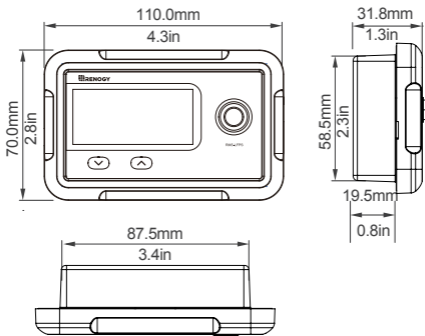

### ■ Additional Components

- **RJ45 Communication Cable**

The RJ45 Communication Cable (5m/16.4ft) is used to connect the monitoring screen to the battery bank for power supply and data transmission.



- **Self-tapping Screws (4)**

The Self-tapping Screws (M2.9x13) are used to fix the monitoring screen on the mounting surface.





# Installation

## ■ Preparation

Before installing the monitoring screen, it is recommended to have the following tools available:

- Pencil
- Drill
- Jigsaw
- Phillips screwdriver

## ■ Choosing an Installation Location

Please choose a clean, dry, protected, and easily accessible indoor location to install the monitoring screen. It is recommended to mount the monitoring screen at eye level for easy access of operational controls and battery information. The RJ45 Communication Port on the monitoring screen is accessible from the back of the unit. Clearance of at least 2 inch (50 mm) behind the unit is recommended to allow for the bending radius of the RJ45 Communication Cable that connects to the monitoring screen.

## ■ Mounting the Monitoring Screen

1. Remove the snap-fit Front Cover Plate from the monitoring screen.
2. Use the monitoring screen as a template to mark the screw holes and trace the cut-out area on the mounting surface with a pencil.
3. Cut out a rectangular area for the monitoring screen on the mounting surface with a jigsaw.
4. Pre-drill four screw holes on the mounting surface with a drill.
5. Place the monitoring screen into the cut-out area and align the mounting holes on the monitoring screen with the pre-drilled screw holes.
6. Affix the monitoring screen on the mounting surface with the included four self-tapping screws.
7. Re-attach the snap-fit Front Cover Plate to the monitoring screen.

---

1

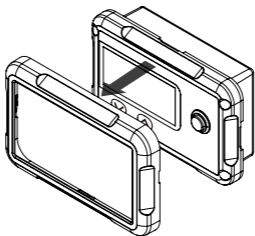

2

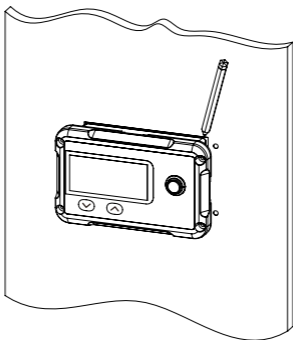

---

3

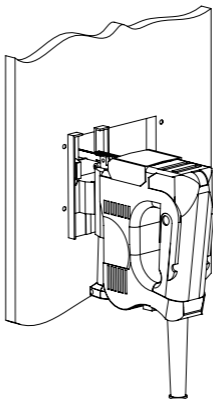

4

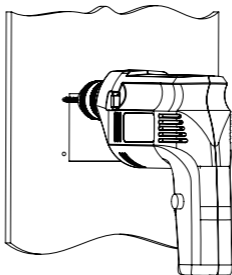

5

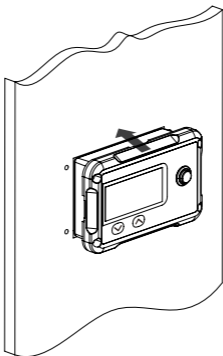

6

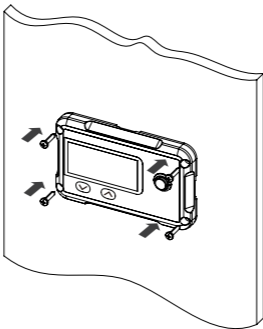

---

7

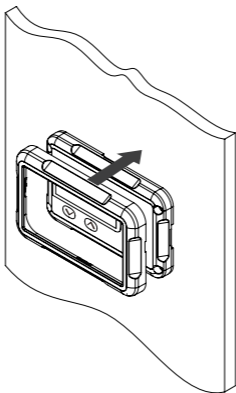

#### ■ Connecting to the Battery

Please connect the monitoring screen to the UP RS485 Communication Port of the battery using the included RJ45 Communication Cable to obtain detailed battery information from the battery management system.

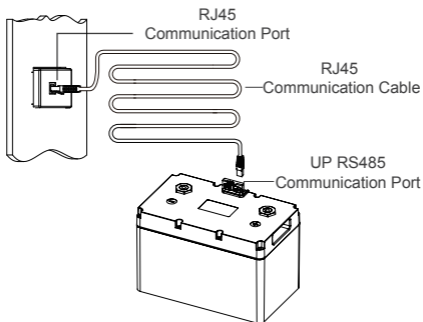

If you are using the monitoring screen with a parallel battery bank, the battery management systems of paralleled batteries must be connected to enable proper communication with the battery bank. Please connect the LINK RS485 Communication Ports of the former batteries to the UP RS485 Communication Ports of the latter ones using CAT5 (or above) Ethernet cables (not included).

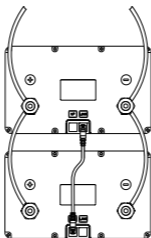

---

**WARNING**

- DO NOT string the batteries in series. Doing so may cause catastrophic failure.

**CAUTION**

- DO NOT string different types of batteries, batteries with different rated capacities, or batteries from different manufacturers in parallel.
- Please avoid too high a voltage difference between paralleled batteries, despite the auto-balancing function, to avoid triggering the over-current protection.
- In parallel battery banks, the cables between each battery should be of equal length to ensure that all the batteries in the system can work together equally.
- It is not recommended to connect more than 4 batteries in parallel if taking advantages of the auto-balancing function.
- Please leave the battery or battery bank in shelf mode during installation. Take care to activate the battery or the battery bank using the monitoring screen ONLY after making sure all the connections are correct and secure.

**NOTE**

- Ethernet crossover cables are not compatible with Renogy systems. Connecting batteries using Ethernet crossover cables may result in damage to the battery management system.
- Please make sure that the battery or the battery bank has been activated using the monitoring screen or the Activation Switch that comes with the battery. Otherwise, no information will be displayed.

## Operation

### ■ LCD Information

#### • Overview

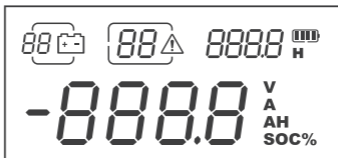

#### • Present Voltage (V)

8888.8<sup>V</sup>

The present voltage indicates the real-time terminal voltage of the battery. If the monitoring screen is connected to a battery bank, the present voltage will be the average terminal voltage of the batteries in the battery bank.

#### • Present Current (A)

-8888.8<sup>A</sup>

The present current indicates the real-time current flowing through the battery or the battery bank. Positive values indicate that the charge current is higher than the discharge current, while negative values indicate that the discharge current is higher than the charge current.



---

- **Capacity (Ah)**

888.8 AH

The capacity indicates the maximum capacity the battery or battery bank can deliver under standard discharge conditions when fully charged. The capacity will diminish gradually with the cycling of the battery or the battery bank.

- **State of Charge (%)**

888.8 SOC%

The state of charge indicates the real-time charge level of the battery relative to its capacity. If the monitoring screen is connected to a battery bank, the state of charge will be the average state of charge of the batteries in the battery bank.

- **Number of Paralleled Batteries**



The number of paralleled batteries indicates the number of batteries connected in parallel in the battery bank. If the communication of one or more batteries in the battery bank is accidentally disconnected or the monitoring screen fails to obtain the information of all batteries after the battery bank is activated from the over-discharge protection state, the battery icon will flash. If a battery is used individually, then the number of paralleled batteries will be 1.

---

- **Remaining Time (Hour)**



The remaining time indicates the time remaining before the battery, or the battery bank, will require a recharge based on current usage rate. If the battery is being charged, the remaining time will not display. If the low voltage warning is triggered during discharge, the remaining time will be 0.0H.

- **Battery Level**



The battery level indicates the charge level of the battery relative to its capacity using four segments. If the present current is positive, the battery segments will blink to indicate the current charge status. Once the battery is fully charged, all battery segments will remain solid. If the monitoring screen is connected to a battery bank, the battery level will indicate the average battery level of the batteries in the battery bank.

- **Error Code**



The error code indicates potentially abnormal conditions of the battery or battery bank. If the battery or the battery bank operates normally, the error code will not display. If the battery or the battery bank is involved with multiple potential abnormal conditions, the monitoring screen will scroll display multiple error codes.

Error Code	Description	Triggering Condition	Recovery Condition
01	Battery High Temperature Warning (Charge/Discharge)	Battery Temperature $\geq 50^{\circ}\text{C}$	Battery Temperature $\leq 45^{\circ}\text{C}$
02	Battery Low Temperature Warning (Charge)	Battery Temperature $\leq 5^{\circ}\text{C}$	Battery Temperature $\geq 10^{\circ}\text{C}$
03	Battery Low Temperature Warning (Discharge)	Battery Temperature $\leq -10^{\circ}\text{C}$	Battery Temperature $\geq -5^{\circ}\text{C}$
04	Battery/Battery Cell Over-voltage Protection	Battery Voltage $\geq 14.8\text{V}$ or Battery Cell Voltage $\geq 3.7\text{V}$	Battery Voltage $\leq 13.8\text{V}$ and Battery Cell Voltage $\leq 3.45\text{V}$ or Discharge Current $\geq 1\text{A}$
05	Battery Under-voltage Warning	Battery Voltage $\leq 12\text{V}$	Battery Voltage $\geq 12\text{V}$
06	Charge Over-current Warning	Charge Current $\geq 60\text{A}$	Charge Current $\leq 55\text{A}$
07	Discharge Over-current Warning	Discharge Current $\geq 110\text{A}$	Discharge Current $\leq 105\text{A}$
08	Battery High Temperature Protection (Charge)	Battery Temperature $\geq 55^{\circ}\text{C}$	Battery Temperature $\leq 50^{\circ}\text{C}$
09	Battery Low Temperature Protection (Charge)	Battery Temperature $\leq 0^{\circ}\text{C}$	Battery Temperature $\geq 5^{\circ}\text{C}$

---

**NOTE**

- Paralleled batteries **MUST** be connected properly using CAT5 (or above) Ethernet cables before connecting to the monitoring screen to reflect an accurate status of the battery bank.
- If the number of paralleled batteries increases after the monitoring screen has been connected to the battery or the battery bank, please long press the Page Up Button and the Page Down Button at the same time for 3 seconds to reset the monitoring screen and update the battery bank information.
- The monitoring screen is **ONLY** able to obtain the information of battery banks with no more than 9 paralleled batteries.

## ■ Button Operation

After connecting the monitoring screen to the battery or battery bank, please press the Power Button on the monitoring screen first to activate the battery or battery bank. The backlight will then be lit and the LCD Display will show the present voltage. If no operations are made within 25 seconds, the backlight will go out and the LCD Display will scroll through the present voltage, present current, capacity, and state of charge.

To display a specific parameter, please press the Page Up Button or the Page Down Button repeatedly until the desired parameter shows up. The backlight will light up once the Page Up Button or the Page Down Button are pressed. If no operations are made in 15 seconds, the backlight will go out and the LCD Display will continue scrolling through the present voltage, present current, capacity and state of charge.

Prior to long periods of storage, please long press the Power Button on the monitoring screen for 3 seconds to put the battery or battery bank into shelf mode.

## Troubleshooting

If any problems occur during battery operation, please refer to the following instructions or contact Renogy for assistance:

- If the monitoring screen does not operate when connected to the battery or the battery bank, please check monitoring screen and battery side connections. If all the connections are solid, please check if the battery or the battery bank has been activated. If the battery or the battery bank cannot be activated using the monitoring screen, it may have entered protection mode and will need special attention. Please refer to the user manual of the battery for more details.
- If the information displayed on the monitoring screen is not accurate, please long press the Page Up Button and the Page Down Button at the same time for 3 seconds to reset the monitoring screen.
- If the monitoring screen displays no information and resets frequently, please reactivate the battery or battery bank by using the Power Button on the monitoring screen.
- If the battery or battery bank is charged immediately after high current discharge, or discharged immediately after high current charge, the monitoring screen may take a while to calibrate before it can display accurate state of charge.

## Technical Specifications

<b>Electrical Specifications</b>	
Supply Voltage	12V DC
Supply Current	30mA
Power Consumption	< 1W
Operating Temperature Range	-4 °F ~113 °F / -20 °C ~45 °C
Voltage Accuracy	±0.1V
Current Accuracy	±0.1A
Certification	FCC Part-15 Class B, CE, RoHS
<b>Mechanical Specifications</b>	
Communication Port	RJ45 (RS485 Protocol)
Display	Backlit LCD
User Interface	2 Front Panel Menu Buttons, 1 Power Button
Mounting System	Wall Mount
Dimension	2.8 x 4.3 x 1.3 inch 70 x 110 x 31.8 mm
Weight	0.14 lbs / 62 g

---

## FCC Compliance:

This device complies with Part 15 of the FCC Rules. Operation is subject to the following two conditions: (1) this device may not cause harmful interference, and (2) this device must withstand any interference received, including interference that may cause undesired operation.

Note: This equipment has been tested and found to comply with the limits for a Class B digital device, pursuant to part 15 of the FCC Rules. These limits are designed to provide reasonable protection against harmful interference in a residential installation. This equipment generates, uses and can radiate radio frequency energy and, if not installed and used in accordance with the instructions, may cause harmful interference to radio communications. However, there is no guarantee that interference will not occur in a particular installation. If this equipment does cause harmful interference to radio or television reception, which can be determined by turning the equipment off and on, the user is encouraged to try to correct the interference by one or more of the following measures:

- Reorient or relocate the receiving antenna.
- Increase the separation between the equipment and receiver.
- Connect the equipment into an outlet on a circuit different from that to which the receiver is connected.
- Consult the dealer or an experienced radio/TV technician for help.

Renogy reserves the right to change the contents of this manual without notice.

**US** | 📍 2775 E Philadelphia St, Ontario, CA 91761, USA  
☎ 909-287-7111  
🌐 [www.renogy.com](http://www.renogy.com)  
✉ [support@renogy.com](mailto:support@renogy.com)

**CN** | 📍 苏州高新区科技城培源路1号5号楼-4  
☎ 400-6636-695  
🌐 <https://www.renogy.cn>  
✉ [support@renogy.cn](mailto:support@renogy.cn)

**JP** | 🌐 <https://www.renogy.jp>  
✉ [supportjp@renogy.com](mailto:supportjp@renogy.com)

**CA** | 🌐 <https://ca.renogy.com>  
✉ [supportca@renogy.com](mailto:supportca@renogy.com)

**AU** | 🌐 <https://au.renogy.com>  
✉ [supportau@renogy.com](mailto:supportau@renogy.com)

**UK** | 🌐 <https://uk.renogy.com>  
✉ [supportuk@renogy.com](mailto:supportuk@renogy.com)

**DE** | 🌐 <https://de.renogy.com>  
✉ [supportde@renogy.com](mailto:supportde@renogy.com)