

SPORTS AFIELD®

Established 1887

INSTINCT SERIES | INSTRUCTION MANUAL



INSTINCT

IMPORTANT:

Please read this information and follow all safety rules carefully before operating your gun safe. Failure to do so will void your warranty.

WARNING



Tip Over Hazard

A child or adult can tip the safe and be killed or seriously injured.

Failure to secure the safe as shown in these instructions can result in death or serious injury to children and adults.

Children should not play with or around the safe at any time.

TABLE OF CONTENTS

1. REGISTRATION	1
2. SAFETY AND STORAGE	1
3. UNDERSTANDING YOUR SAFE	2
4. UNBOXING	2
5. INSPECTION	2
6. OPENING YOUR SAFE	3
7. PROPER PLACEMENT AND MOVING OF SAFE	4
8. KEEPING YOUR SAFE DRY	4
9. SKID REMOVAL AND SECURING	5
10. GUN REST INSTALLATION	6
11. E-LOCK INSTALLATION	7
12. LOW BATTERY WARNING	7
13. SECURITY CODE SETUP FOR NON ILLUMINATED E-LOCKS	8
WARRANTY	9
14. E-LOCK QUIET MODE	9
(NOW A PART OF SECURITY CODE SETUP)	
13. LOCKED OUT OF YOUR SAFE	9
(NOW A PART OF SAFETY SECTION ON PAGE 2)	

THIS MANUAL SERVICES THE FOLLOWING STYLE NUMBERS

SA5532INS

SA5529INS

SA5525INS

SA5520INS

SA5516INS

1. REGISTRATION

Please ensure you register your safe by visiting our website. Locate the “contact” button on the top header on the home page. Select registration from the drop down menu.

www.sportsafieldsafes.com

By registering your Sports Afield Safe we will be able to expedite and address any problems or challenges you may have which would otherwise require a notary letter and proof of payment.

REGISTRATION INFORMATION

The information you record onto this page will be required in the event you cannot access the contents of your Sports Afield Safe. Please fill out all the required information below and retain for your records and safe keeping.

PLEASE HAVE THIS INFORMATION READY PRIOR TO CALLING FOR TECHNICAL ASSISTANCE AT:

Customer Service - (888) 792-4264

PURCHASE DATE:

PURCHASE PRICE (BEFORE TAX):

MODEL NUMBER:

SERIAL NUMBER:

RETAILER PURCHASED AT:

KEY NUMBER (IF APPLICABLE):

DISCLAIMER - READ BEFORE SAFE SETUP

PLEASE READ THIS INFORMATION CAREFULLY BEFORE OPERATING YOUR SPORTS AFIELD SAFE.

DO NOT LOCK THIS MANUAL OR THE OVERRIDE ACCESS KEYS IN YOUR SAFE.

- Thank you for choosing a Sports Afield Safe to protect your valuables. We are committed to securing, organizing and protecting your most important documents, valuables and keepsakes.
- Your safe is built to last a lifetime. However, please understand that the locking mechanism has precision parts. If you experience ANY difficulty opening or closing your safe, **DO NOT FORCE THE SAFE OPEN**. Doing so may jam the components in the lock, which will require a safe technician to unlock your safe. This causes an inconvenience to you and may lead to a claim denial.
- If you experience problems or challenges with your safe, please contact us. Many issues can be quickly resolved without the product being returned.

Customer Service - (888) 792-4264

SAFETY

- Safe bodies and doors are extremely heavy thus SA Consumer Products Requires a minimum of two people to insure stability of the safe during installation. Always ensure proper installation, as laid out in this manual, and do not open the door with the safe on an uneven or unstable floor. Ignoring this could result in serious injury or death.
- Keep a record of your combination number in a secure place, away from children, and separate from your safe. You will need this information along with your proof of purchase to obtain technical assistance and replacement keys.

WEAPON STORAGE

- If you choose to utilize this safe to store a weapon always follow proper weapon and local laws when storing a weapon.
- SA Consumer Products strongly recommends that you do not store loaded guns.
- Always follow the firearm safety rules set out by the firearm's manufacturer.
- A Sports Afield Safe or any other firearm storage device cannot take the place of other safety procedures including advising children of the dangers of firearms.
- SA Consumer Products and its distributors of the Sports Afield Safes do not recommend, suggest, advise, promote, or otherwise condone the ownership or use of firearms. We believe the decision to own or use a firearm is a serious decision that should only be made by an adult who has carefully considered the risks and benefits of such a decision.

2. SAFETY AND STORAGE - READ BEFORE SAFE SETUP

Thank you for choosing a Sports Afield Safe to protect your valuables. We are committed to securing, organizing and protecting your most important documents, valuables and keepsakes.

SAFETY

- Safe bodies and doors are extremely heavy thus SA Consumer Products Requires a minimum of two people to insure stability of the safe during installation. Always ensure proper installation, as laid out in this manual, and do not open the door with the safe on an uneven or unstable floor. Ignoring this could result in serious injury or death.
- Your safe is built to last a lifetime. However, please understand that the locking mechanism has precision parts. If you experience **ANY** difficulty opening or closing your safe. **DO NOT FORCE THE SAFE OPEN**. Doing so may jam the components in the lock, which will require a safe technician to unlock your safe. This causes an inconvenience to you and may lead to a claim denial.
- Keep a record of your combination number in a secure place, away from children, and separate from your safe. You will need this information along with your proof of purchase to obtain technical assistance and replacement keys.

- **In the event that you are locked out of the safe, you should use your backup keys to gain access** followed by the E-Lock Security Setup Code instructions, starting at step 2 of activating the brass reset button. As a general rule, **never close the safe door without your access keys and manual in hand**.
- **If you have lost your backup keys, contact customer service at (888) 792-4264.** Proof of purchase is required to obtain keys.

Customer Service - (888) 792-4264

WEAPON STORAGE

- Make sure to advise children of the dangers of firearms. When storing a weapon, follow all local laws and safety rules from the firearms' manufacturer.
- Do not store loaded guns. Ammunition should be stored separately from valuables.
- Store heavier items and heat sensitive items on the floor of the safe.
- Do not put anything in your safe that will put pressure against the door when it is closed.
- When loading guns into your safe, make sure they rest securely against the cutouts provided in the gun racks to prevent accidental tipping when the door is closed.
- SA Consumer Products and its distributors of the Sports Afield Safes do not recommend, suggest, advise, promote, or otherwise condone the ownership or use of firearms. We believe the decision to own or use a firearm is a serious decision that should only be made by an adult who has carefully considered the risks and benefits of such a decision.

3. UNDERSTANDING YOUR SAFE

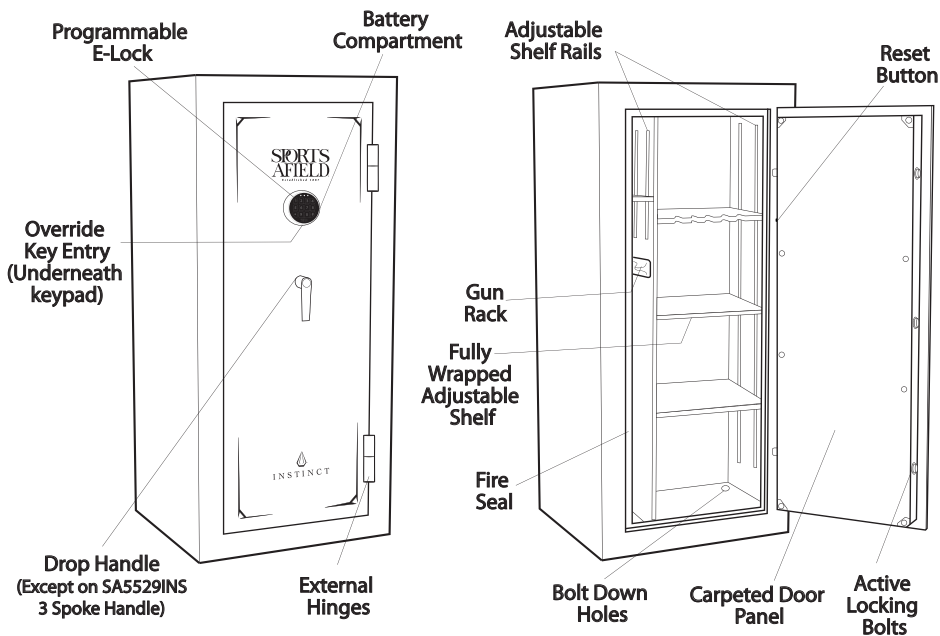

4. UNBOXING

WARNING: SAFES ARE HEAVY AND CAN BE UNSTABLE ON UNEVEN GROUND. PLEASE ENSURE EXTRA CAUTION WHEN DEALING WITH OR MOVING UNSECURED SAFES. WHILE UNBOXING BE SURE TO HAVE A SECOND PERSON HOLD AND STABILIZE THE SAFE TO KEEP IT FROM TIPPING, CAUSING INJURY, AND/OR DAMAGE TO THE SAFE AND SURROUNDING STRUCTURES.

- Remove the packaging. If your safe is still on shipping feet you can simply lift the box up and off the safe once the strapping has been removed. If your safe does not have shipping feet you will need to carefully remove the box, ensuring not to damage the safe and/or injure yourself. You will want to have someone stabilize the safe when removing the cardboard and other packing material from underneath the safe.

5. INSPECTION

- Make sure to inspect your safe for shipping damage before accepting delivery. If you find any damage, please contact the delivery company (or carrier) immediately.
- Any damage not noted upon delivery must be reported within fifteen (15) days or there will be no recourse. Any noted damage at the time of delivery must be resolved with the delivery company and/or retailer. Shipping damage is not warrantable by SA Consumer Products.

3. UNDERSTANDING YOUR SAFE

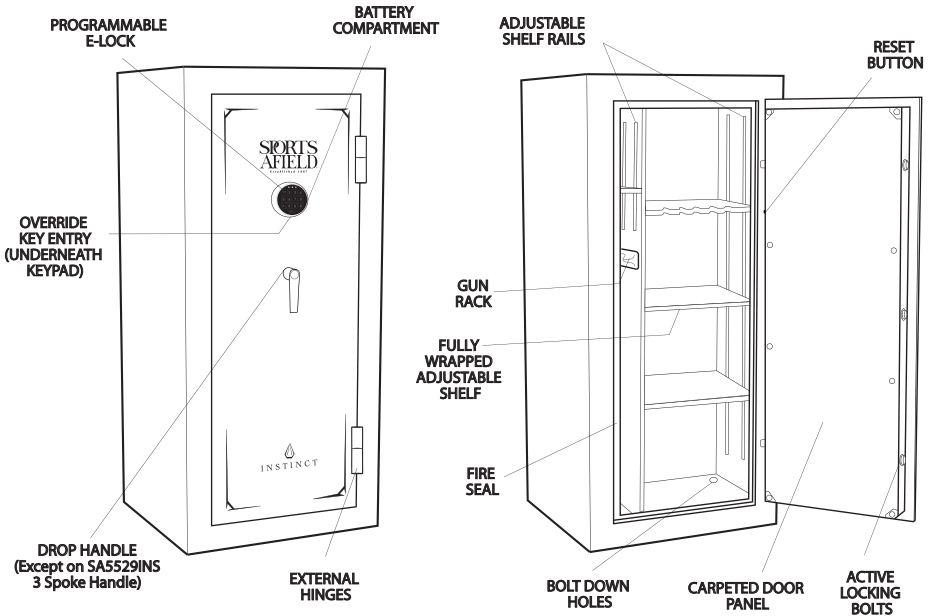

NOTE: HINGES AND INTERNAL LOCKING MECHANISM ARE PERMANENTLY LUBRICATED AND MAINTENANCE-FREE. OPENING THE DOOR PANEL OF YOUR SAFE MAY VOID YOUR WARRANTY. ALWAYS CONSULT OUR CUSTOMER SERVICE EXPERTS PRIOR TO DOING SO.

4. UNBOXING

WARNING: safes are heavy and can be unstable on uneven ground. Please ensure extra caution when dealing with or moving unsecured safes. While unboxing be sure to have a second person hold and stabilize the safe to keep it from tipping, causing injury, and/or damage to the safe and surrounding structures.

Remove the packaging. If your safe is still on shipping feet you can simply lift the box up and off the safe once the strapping has been removed. If your safe does not have shipping feet you will need to carefully remove the box, ensuring not to damage the safe and/or injure yourself. You will want to have someone stabilize the safe when removing the cardboard and other packing material from underneath the safe.

5. INSPECTION

Make sure to inspect your safe for shipping damage before accepting delivery. If you find any damage, please contact the delivery company (or carrier) immediately.

Any damage not noted upon delivery must be reported within fifteen (15) days or there will be no recourse. Any noted damage at the time of delivery must be resolved with the delivery company and/or retailer. Shipping damage is not warrantable by SA Consumer Products.

6. OPENING YOUR SAFE

1. Locate the override keys inside the plastic bag hanging on the front of the safe.

The SA5529INS model also includes a single spoke. Install the spoke into the central hub by threading it into any of the three openings

Step 1

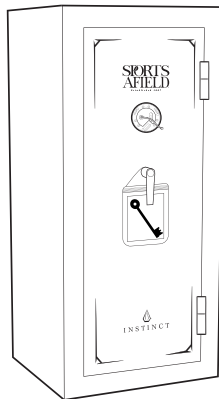

CONTENTS:
USERS MANUAL
AND FAILSAFE KEY



2. Locate the keyhole in the backer plate. Insert and turn the override key clockwise from 12 to the 3 o'clock position to unlock.

Step 2

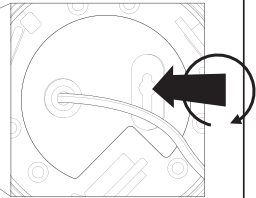
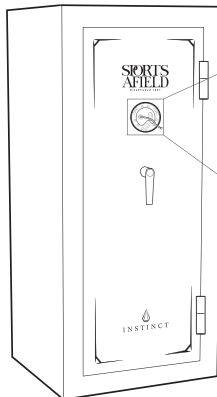

3. To open the door, turn the handle counter-clockwise (clockwise for SA5529INS). Once open, turn the handle back to its starting position so the bolts are open and extended. Remove key.

Step 3

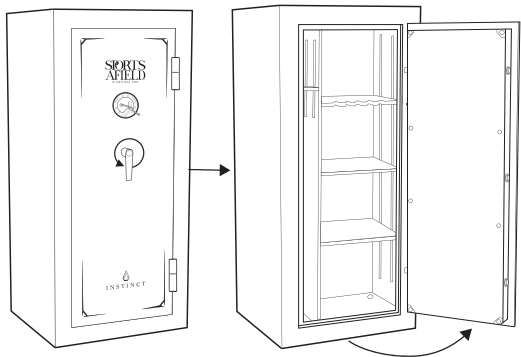

7. PROPER PLACEMENT AND MOVING OF SAFE

WARNING: SAFES ARE VERY HEAVY AND AWKWARD TO HANDLE. PLEASE USE THE UTMOST CARE IN MOVING THE SAFE. UTILIZING A TRAINED PROFESSIONAL WITH PROPER MOVING EQUIPMENT IS HIGHLY RECOMMENDED.

The location of the gun safe is very important and the utmost care should be taken during this consideration.

1. To maximize the fire protection of your safe, we recommend you place the safe in lower levels in your home where fire temperatures are lower and away from highly combustible materials.
2. To maximize burglary protection and stability, securing the safe to the floor is recommended.
3. SA Consumer Products recommends that you store your safe in a closet, office, basement, bedroom or any other location that is convenient for you but out of direct line of sight from prying eyes. The location of the gun safe is very important.

Using a dolly capable of supporting the size and weight of your safe, move the safe to your desired location. Please take all necessary precautions to protect and prevent any damage to your flooring.

HELPFUL: TO DETERMINE WHETHER YOUR SAFE WILL MAKE IT THROUGH DOORWAYS, STAIRS, OR CORNERS, TAKE THE EMPTY SAFE BOX AND SEE IF IT WILL FIT ALL THE WAY THROUGH TO ITS FINAL LOCATION.

1. The safe should be installed adjacent to a side wall with minimal space on either side of the safe. Wherever possible, the safe should be flat against the wall and floor. Remove the baseboard and/or wall trim if necessary.
2. Always ensure the safe is in an isolated and dry area. Never place the safe in direct contact with a wet floor. When installing your safe on a concrete floor, use of a moisture/protective barrier is highly recommended. Failure to do so, or exposing the safe to chemicals or other adverse environments, may void the warranty.
3. If your safe seems unlevel, you may need to shim the bottom of the safe to prevent the door from swinging open too quickly, or closing on itself.

8. KEEPING YOUR SAFE DRY

We recommend placing a moisture/protective barrier between your safe and concrete floor to prevent any moisture, mildew and rust damage the safe. Installing your safe in a place with climate control (heat in the winter and cooling in the summer) is highly recommended. In areas of high humidity or frequent temperature fluctuations (garages) it is recommend to take appropriate precautions to ward against moisture damage. We strongly encourage the use of an internal dehumidifier and/or desiccants to protect your contents from rust or mildew. Internal dehumidifiers should not be in direct contact with the side or back walls.

8. SHIPPING AND SKID REMOVAL

WARNING: WHILE REMOVING THE BOLTS FROM THE SKIDS, BE SURE TO HAVE A PERSON HOLD AND STABILIZE THE SAFE TO KEEP IT FROM TIPPING, CAUSING INJURY, AND/OR DAMAGE TO THE SAFE AND SURROUNDING STRUCTURES.

WARNING: BEFORE REMOVING THE SHIPPING SKIDS, MAKE SURE THE DOOR IS CLOSED AND LOCKED. THE DOOR OF YOUR SAFE IS HEAVY AND PRESENTS A SAFETY HAZARD UNTIL THE SAFE IS BOLTED DOWN OR SECURED PROPERLY.

1. Upon receiving your safe, you may find it attached to a shipping skid. The skid is secured from the underside of the safe by four bolts. Remove the four bolts that secure the safe to the skids using a wrench or 11/16" (17mm) socket.
2. With a person stabilizing the safe, carefully tilt the safe to the left and pull the shipping skid on the right side away from the bottom of the safe.
3. With the shipping skid removed from one side of the safe, carefully lower the safe to the floor.
4. Follow the same procedure to remove the remaining shipping skid.

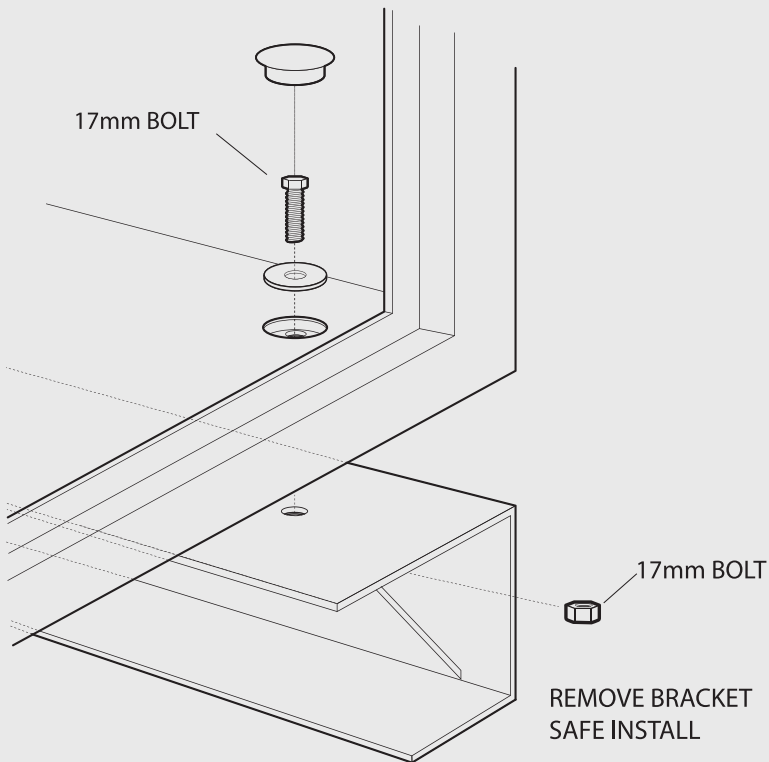

9. SECURING YOUR SAFE

WARNING: YOUR SAFE IS DESIGNED TO SUPPORT ITSELF WHEN THE DOOR IS OPENED. HOWEVER, CAUTION SHOULD BE USED TO AVOID TIPPING. WHILE SECURING YOUR SAFE BE SURE TO HAVE A SECOND PERSON HOLD AND STABILIZE THE SAFE TO KEEP IT FROM TIPPING, CAUSING INJURY, AND/OR DAMAGE TO THE SAFE AND SURROUNDING STRUCTURES. FAILURE TO DO SO WILL COMPROMISE THE SAFETY, SECURITY, AND WARRANTY OF THE SAFE.

TOOLS NEEDED TO BOLT SAFE TO A CONCRETE SURFACE

- DRILL / HAMMER DRILL
- DRILL BIT – 1/2" (for installing into concrete with provided hardware)
- WRENCH / 11/16" (17MM) SOCKET
- HAMMER

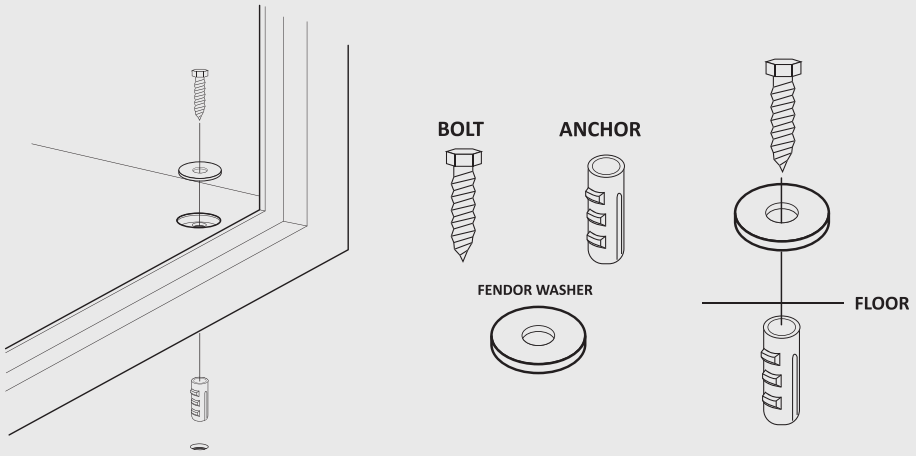

1. Use the hardware provided or consult your hardware retailer for fastening hardware for your particular mounting surface.
2. Open your safe door and locate and remove the four black caps on the safe floor. This will provide access to the factory drilled bolt down holes.
3. To secure your safe to the floor it will first be necessary to drill pilot holes in the floor surface.
4. Drill the appropriate diameter and depth of pilot holes based on the type of hardware being used and the type of floor surface. For the hardware provided (concrete floor installation) we recommend using a hammer drill and 1/2" concrete drill bit to drill holes the four corresponding in the concrete floor.
5. Insert and drive the plastic anchoring plugs into the pilot holes. You may need to use a hammer to fully insert the plugs into the pilot holes.
6. Secure the safe, by threading all 4 anchor bolts through the factory drilled bolt down holes in the bottom of the safe and ratcheting down tight.
 - Make sure the metal washer sits on top of the rubber washer. Tighten the bolt to compress the rubber washer between the safe and metal washer. Failure to do so will allow water to enter the safe in the event of a flood.
7. Replace the four black caps onto the floor of the safe.

9. SKID REMOVAL AND SECURING

TOOLS FOR SKID REMOVAL & SECURING

- DRILL / HAMMER DRILL
- DRILL BIT – 1/2" (For installing into concrete with provided hardware)
- WRENCH / 11/16" (17mm) SOCKET
- HAMMER

FASTENING HARDWARE

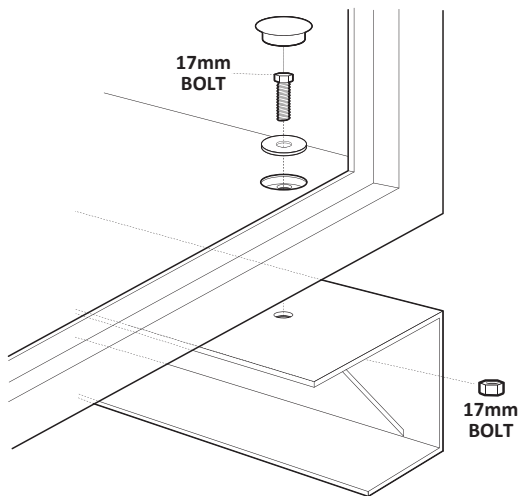
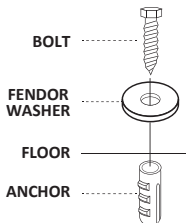

WARNING: A second person must hold and stabilize the safe to keep it from tipping, causing injury, and/or damage to the safe and surrounding structures. Make sure the door is closed and locked while removing the skids. Failure to do so will compromise the safety, security, and warranty of the safe. Use the hardware provided or consult your hardware retailer for skid removal and fastening to mounting surface.

1. Remove the four bolts that secure the safe to the skids using a wrench or 11/16" (17mm) socket.
2. With a person stabilizing the safe, carefully tilt the safe to the left and pull the shipping skid on the right side away from the bottom of the safe.
3. With the shipping skid removed from one side of the safe, carefully lower the safe to the floor. Follow the same procedure to remove the remaining shipping skid.
4. Open your safe door and locate and remove the four black caps on the safe floor. This will provide access to the factory drilled bolt down holes.

To secure your safe to the floor it will first be necessary to drill pilot holes in the floor surface.

5. Drill the appropriate diameter and depth of pilot holes based on the type of hardware being used and the type of floor surface. For the hardware provided (concrete floor installation) we recommend using a hammer drill and 1/2" concrete drill bit to drill holes the four corresponding in the concrete floor.
6. Insert and drive the plastic anchoring plugs into the pilot holes. You may need to use a hammer to fully insert the plugs into the pilot holes.
7. Secure the safe, by threading all 4 anchor bolts through the factory drilled bolt down holes in the bottom of the safe and ratcheting down tight.
 - Make sure the metal washer sits on top of the rubber washer. Tighten the bolt to compress the rubber washer between the safe and metal washer. Failure to do so will allow water to enter the safe in the event of a flood.
8. Replace the four black caps onto the floor of the safe.

10. GUN REST INSTALLATION

1. Locate the gun racks that will be part of your safe assembly kit. Find the pre-drilled drywall anchors that are located on the back and side walls of your safe. Select the ideal location(s) for your gun rack(s) that best fit your custom storage needs.
2. Insert bolts, as shown below, into the two pre-drilled holes in your gun rack, through the drywall anchor on the interior of your safe to secure the gun rack in place.

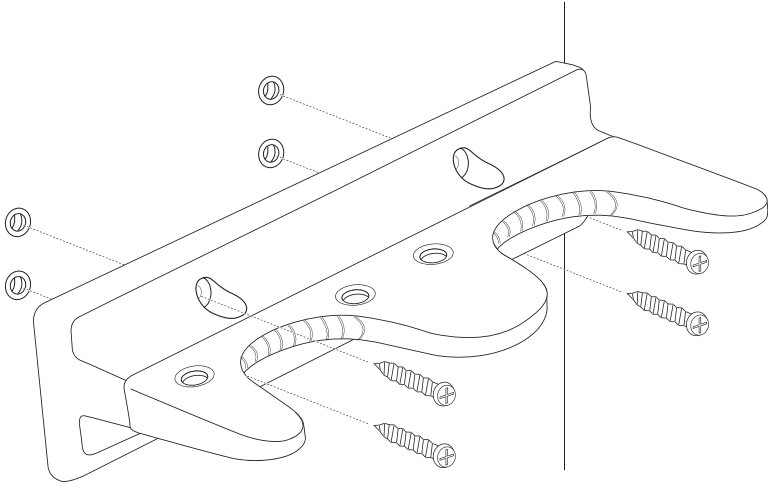

Scoped firearms will require additional clearance from the cabinet walls. Installing Standoffs will distance the scope from the cabinet wall, ensuring no damage to the scope or firearm.

1. Locate the standoffs inside the cabinet assembly kit located inside of your cabinet. Simply clip the two attachment points into the holes located on top of the gun rest to fully secure.

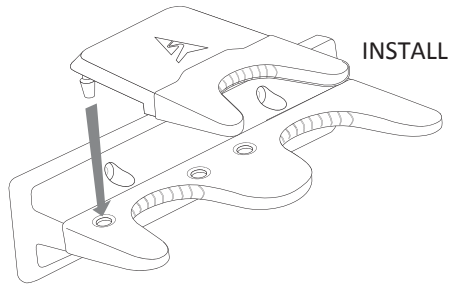

2. Standoffs are designed to clip at any position in any quantity along the gun rest brackets to suit your needs. The standoffs can be easily removed or transitioned to another area by pulling directly up and twisting on the opposite end of the attachment points to safely remove.

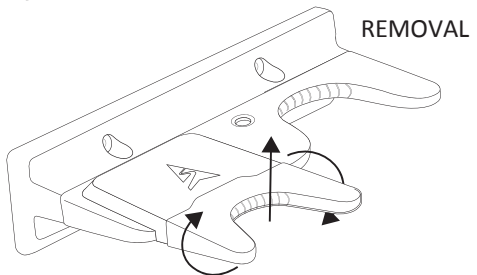

11. E-LOCK INSTALLATION

1. Remove lock face from box located inside of safe.

Step 1

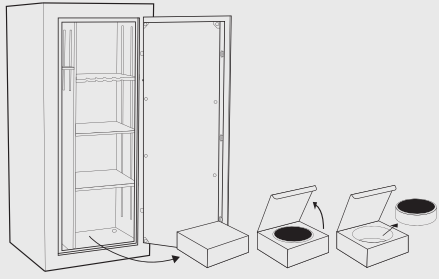

2. The e-lock requires 1x9V alkaline battery. The battery compartment is located on the back of the lock face. Insert the battery in the proper orientation. Keypad will beep when batteries are successfully installed.

WARNING: The batteries must be inserted with the correct polarity. Exhausted batteries must be removed from the product and discarded safely. Do not mix old and new batteries. Do not mix alkaline or standard (carbon – zinc) batteries. Do not use rechargeable (nickel – cadmium) batteries.

Step 2

FRONT OF LOCK FACE

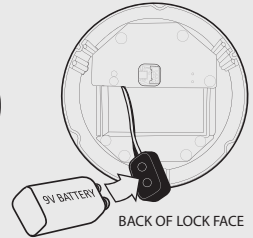

3. Plug E-lock cable into the back of the E-lock. The cable connector will only fit one way into the connector in the lock face.

Step 3

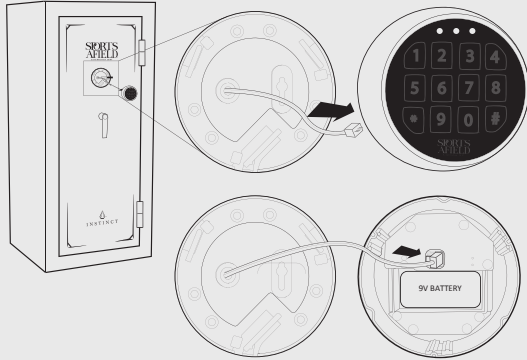

4. Install the E-Lock onto the safe door by aligning the lock face to the backer plate and turning clockwise until you feel the E-lock click into place.

The SA5529INS model will have two remaining handles inside of the safe. Locate and install them into the threaded openings of the central hub.

Step 4

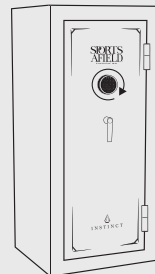

11. E-LOCK INSTALLATION

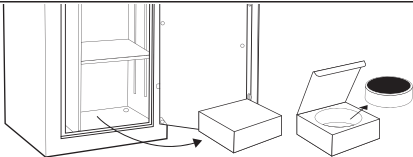
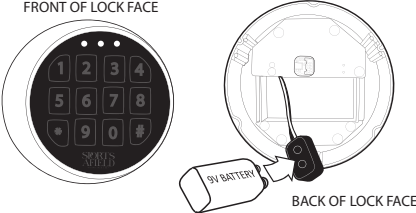
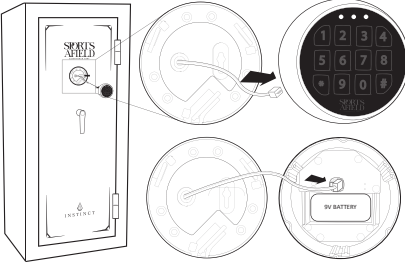
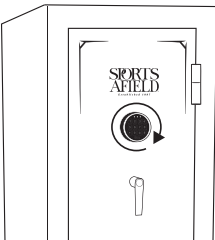
<p>1. Remove lock face from boxlocated inside of safe.</p>	
<p>2. The e-lock requires 1x9V alkaline battery. The battery compartment is located on the back of the lock face. Insert the battery in the proper orientation. Keypad will beep when batteries are successfully installed.</p>	<p>FRONT OF LOCK FACE</p>  <p>BACK OF LOCK FACE</p>
<p>3. Plug E-lock cable into the back of the E-lock. The cable connector will only fit one way into the connector in the lock face.</p>	
<p>4. Install the E-Lock onto the safe door by aligning the lock face to the backer plate and turning clockwise until you feel the E-lock click into place.</p> <p>The SA5529INS model will have two remaining handles inside of the safe. Locate and install them into the threaded openings of the central hub.</p>	

WARNING: The batteries must be inserted with the correct polarity. Exhausted batteries must be removed from the product and discarded safely. Do not mix old and new batteries. Do not mix alkaline or standard (carbon – zinc) batteries. Do not use rechargeable (nickel – cadmium) batteries.

12. LOW BATTERY WARNING

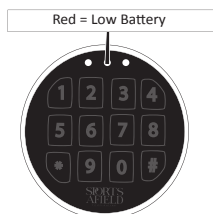

- This E-Lock is equipped to alert you when the batteries are low by illuminating the red light (center) when any button is pressed on the keypad. Please replace batteries immediately when receiving this warning.
- Always test the batteries when installing or replacing. If the red light comes on when a button is pressed you know the batteries are not fully charged.

12. SECURITY CODE SETUP FOR NON ILLUMINATED E-LOCKS

Important: It is necessary to re-program your safe with a new security code you have personally selected to provide maximum household security. Be careful, in choosing your new security code, you'll want to be sure that you can operate the unit quickly without making an error.

1. Key in the preset factory code [1 5 9 #].
The right light will turn green. Turn the handle to ensure bolts are activated. Once confirmed return handle to starting position to lock bolts out.

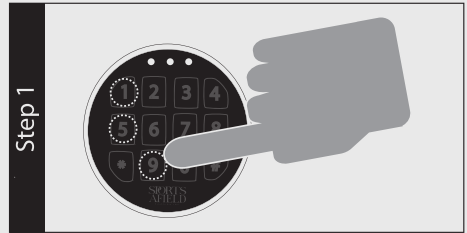

2. On the inside of the safe door, locate the small brass cap. Unscrew and remove the cap, you will now see the reset button. Press and release the reset button. You will hear a beep. The yellow (left) light on the E-lock will illuminate so that you can enter your new code.

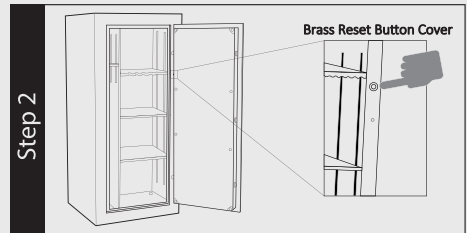

3. Enter your new 3 to 8 digit security code while the yellow (left LED) light is illuminated followed by the [*] symbol. Keypad will beep twice after pressing the [*] symbol. Reenter new code, now followed by the [#] symbol. The Keypad will flash yellow (left LED), beep twice, then flash green (right LED).

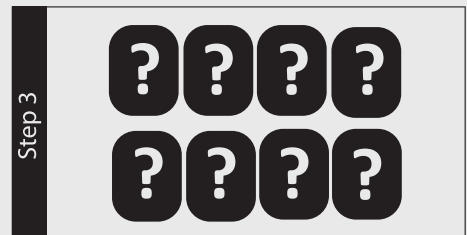

4. While the safe door is still open, confirm your newly entered security code. Confirm code by entering the 3-8 digit code followed by the [#]. If successful you will hear two beeps and the green light will illuminate, allowing you to retract the bolts.

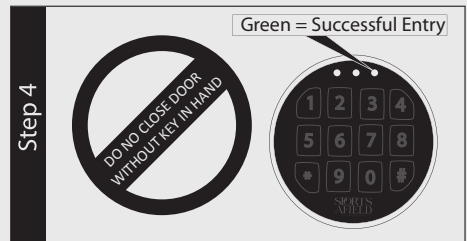





Note: Do not shut the safe door until you have confirmed your new security code at least 3 times to ensure your code has been saved and you can open the door successfully. If the code fails, the yellow (left) light will flash and beep. Repeat the steps above until successful.

Warning: If the incorrect security code is entered 3 times you will have an automatic lockout for 30 seconds before you can enter your code again. If 3 additional failed attempts are made, the keypad will lockout for 5 minutes. Leave batteries in to go through lockout cycle. If batteries are removed the timer will restart zero.

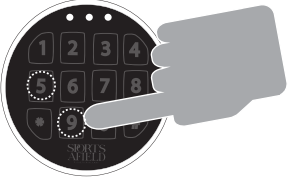
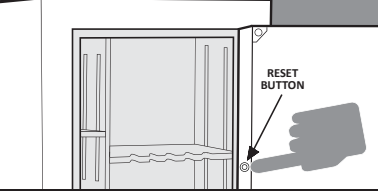
13. SECURITY CODE SETUP FOR NON ILLUMINATED E-LOCKS

Reprogram your safe with a new 3 to 8 digit security code of your choice. Make sure your code is both secure and easy to remember so that you can operate the unit quickly without making an error.

<p>1. Key in the preset factory code [1 5 9 #]. The right light will turn green. Turn the handle to ensure bolts are activated. Once confirmed return handle to starting position to lock bolts out.</p>	
<p>2. On the inside of the safe door, locate and unscrew the reset button cap. Press and release the button. After a beep, the yellow light on the E-lock will illuminate.</p>	
<p>3. While the yellow light is illuminated, enter your new code and press the [*] symbol. The keypad will beep twice. Enter the new code again and press the the [#] symbol. The Keypad will flash yellow, beep twice, then flash green.</p>	
<p>4. Do not close door without key in hand. Keep the safe door open while confirming the code setup was successful. Enter your security code and the [#] symbol. If successful there will be two beeps and a green light.</p>	
<p>5. Silent Mode (Optional) Now that you have successfully set up your security code, you may want to enable silent access. Simply enter the code [*633] to enter silent mode and [*66] to turn the sound back on.</p>	

Note: Do not shut the safe door until you have confirmed your new security code at least 3 times and you can open the door successfully. If the code fails, the yellow light will flash and beep. Repeat the steps above until successful.

Warning: If the incorrect security code is entered 3 times you will have an automatic lockout for 30 seconds before you can enter your code again. If 3 additional failed attempts are made, the keypad will lockout for 5 minutes. Leave batteries in to go through lockout cycle. If batteries are removed the timer will restart zero.

13. LOW BATTERY WARNING

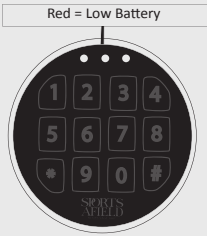

- This E-Lock is equipped to alert you when the batteries are low by illuminating the red light (center) when any button is pressed on the keypad. Please replace batteries immediately when receiving this warning.
- Always test the batteries when installing or replacing. If the red light comes on when a button is pressed you know the batteries are not fully charged.

14. E-LOCK QUIET MODE

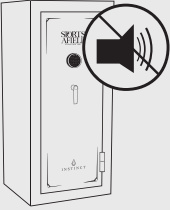

- By activating the E-lock quiet mode, the safe will no longer make audible sound when interacting with safe, allowing for silent access.
1. To mute the E-Lock, enter the code [* 6 3 3].
 2. To turn the sound back on, enter code [* 6 6].

15. LOCKED OUT OF YOUR SAFE

In the event you have forgotten the security code your primary action will be to use your backup keys in order to gain access to your safe and follow the E-Lock Security Setup Code instructions, starting at step 2 of activating the brass reset button.

If you have lost your backup keys, you will need to contact customer service at the number below. Proof of purchase is required to obtain keys.

Customer Service - (888) 792-4264

16. LOADING YOUR SAFE

1. Store documents or heat sensitive items in the bottom of the safe for greatest protection against fire damage.
2. Store ammunition separately from valuables.
3. Do not put anything in your safe that will put pressure against the door when it is closed.
4. Select safe models have reinforced shelving, but as a good safety precaution store heavier items either on the floor of the safe, or away from the middle of the shelves.
5. When loading guns into your safe, make sure they rest securely against the cutouts provided in the gun racks to prevent accidental tipping when the door is closed.

17. MAINTAINING HINGES AND INTERNAL MECHANISMS

The hinges and internal locking mechanism are permanently lubricated, thus needing no maintenance. Opening the door panel of your safe may void your warranty. Always consult our customer service experts prior to doing so.

LIFETIME WARRANTY

SA Consumer Products, Inc. will repair or replace, at their sole discretion, any Sports Afield Gun Safe damaged by fire, forced entry, forced attack or natural flood for the lifetime of the original owner.

SA Consumer Products, Inc. will repair or replace, at their sole discretion, any Sports Afield Gun Safe with defective parts, paint or lock for the lifetime of the original owner.

If SA Consumer Products, Inc. deems a replacement safe is to be sent, they will pay the freight costs to ship the replacement safe to the original owner.

This lifetime warranty is limited to the safe and expressly excludes any loss associated with the contents of the safe.

SA Consumer Products, Inc. reserves the right to receive full evidence of your misfortune, such as a police report and/or homeowners statement of coverage. This warranty is not valid outside of the United States and Canada.

Proof of registration and copy of sales receipt must be on file at the time of claim. Visit our website at www.sportsafieldsafes.com to register your safe.

Lifetime warranty only applies to the original owner of the safe.

SA Consumer Products, Inc. shall only be responsible and liable when the safe is used in compliance with the directions specified in your new Sports Afield Safe Owner's Manual.

SA Consumer Products, Inc. requires that specific guidelines be followed for repair. The safe will be repaired in-home if possible (to include parts and labor); however, if factory replacement is necessary (at SA Consumer Products, Inc.'s sole discretion), the replacement will be shipped freight prepaid, curbside delivery.

This warranty is inclusive and is in lieu of any and all other warranties, express or implied. Specifically excluded are the warranties of merchantability and fitness for a particular purpose. This warranty is limited to the safe itself and/or its value and does not include consequential damages of any kind including, but not limited to, the contents in and of the safe.