

Mix Series



Mix Series Design features



1. Fluid™ Concrete

Incredibly strong yet relatively lightweight, EcoSmart's concrete products incorporate revolutionary Fluid Concrete Technology. Fluid features a stain and impact-resistant barrier that protects the concrete from environmental weathering – even under extreme conditions and long UV exposure.

Environmentally-Friendly

Bioethanol fireplaces use an environmentally-friendly, renewable energy source that burns clean and delivers warming heat. You and your guests will enjoy the ambiance and tranquility of a real fire, without the hassles of burning real wood - no more embers, ash, and soot to clean up.

Surround Colours

Our Fires are available in three Fluid Concrete colours.



Natural



Graphite



Bone

2. Decorative Media

Concrete models come with black glass charcoal.

3. Articulating Feet

Our Fire Pits and Tables feature 360° height-adjustable articulating feet, so you can achieve a perfectly level and stable model before operating the fireplace.

Versatile & Incredibly Durable

EcoSmart portable fireplaces are versatile, incredibly durable, and are constructed of weather resistant materials. These appliances are designed to look great for years, and will perform admirably through all four seasons.

4. Burner Colours

Available with a Stainless Steel or Black Burner.

Available in 2 Sizes

Mix 850 stands 310mm [12.2in] tall, 850mm [33.5in] wide. The smaller Mix 600 stands 220mm [8.7in] tall, 600mm [23.6in] wide.

Quick & Easy Installation

With no installation or building works required, simply unpack, put into position, and off you go.

Ground Fixing Brackets

Models come with fixing brackets for permanently locating into a fixed position.

Global Compliance

These models comply with existing standards in the USA and Australia. O-TL listed to UL 1370 and ACCC Safety Mandate compliant.

Included Accessories



Jerry Can with Safety Spout & e-NRG bottle adaptor



Lighting Rod & Lighter



AB8 Efficiency Ring
(Mix 850 only)



Jerry Can Spout Extension
(Mix 600 only)



Black Glass Charcoal

Optional Accessories



Outdoor Cover





Disclaimer: All product specifications and data are subject to change without notice and believed to be correct at the time of publication. MAD Design Group (MDG), its affiliates, agents, and employees, and all persons acting on its or their behalf (collectively, "MAD Design Group"), disclaim any and all liability for any errors, inaccuracies or incompleteness contained herein or in any other disclosure relating to any product. MDG disclaims any and all liability arising out of the use or application of any product described herein or of any information provided herein to the maximum extent permitted by law. The product specifications do not expand or otherwise modify MDG's terms and conditions of purchase, including but not limited to the warranty expressed therein, which apply to these products. No license, express or implied, by estoppel or otherwise, to any intellectual property rights is granted by this document or by any conduct of MDG. Customers using or selling MDG products not expressly indicated for use in such applications do so entirely at their own risk and agree to fully indemnify MDG for any damages arising or resulting from such use or sale. Please contact authorised personnel from MDG to obtain written terms and conditions regarding products designed for such applications. Images are indicative only.

Mix 850 Specifications

A simple, elegantly shaped outdoor fire pit, the Mix 850 beautifully illuminates outdoor and indoor spaces and brings people together.

Burner Ventilation and Efficiency*

Dimensions L x W x H mm/in	Compatible Burner	Fuel Capacity	Heats on Average (Indoors)	Thermal Output Net (MAX)	Approx. Burn Time	Minimum Room Size
850 x 850 x 319 33.5 x 33.5 x 12.5	AB8	8 L [2.1 Gals]	Over 60 m ² [645 ft ²]	21.56 MJ/h 20,433 BTU/h 5.99 kW	7 - 9 hours	116 m ³ [4,096 ft ³]

Application	Outdoor
Surround Colours	<div style="display: flex; justify-content: space-around;"> <div style="text-align: center;">  Natural ESF.O.MX8.NA </div> <div style="text-align: center;">  Graphite ESF.O.MX8.GH </div> </div> <div style="text-align: center; margin-top: 10px;">  Bone ESF.O.MX8.BO </div>
Burner Colours	<div style="display: flex; justify-content: space-around;"> <div style="text-align: center;">  Stainless Steel </div> <div style="text-align: center;">  Black </div> </div>
Materials	Fluid Concrete Surround, Grade 304 Stainless Steel Burner, with optional Black Ceramic Coating
Approx. Weight	47.6kg [104.8lbs] Weight includes burner and black glass charcoal.
Fuel Type	e-NRG Bioethanol / e-NRG.com

*These values are indicative only and may vary depending on the model purchased, installation, and the seasonal resource used to manufacture e-NRG. This model comes with fixing brackets for permanently locating into a fixed position. This model complies with existing standards in the USA and Australia. O-TL listed to UL 1370 and ACCC Safety Mandate compliant.

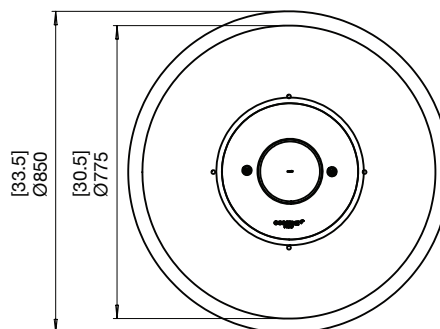
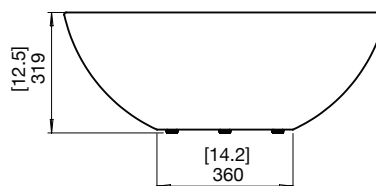







FOR MORE INFORMATION PLEASE REFERENCE THE CLEARANCE & INSTALLATION MANUAL



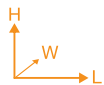

Disclaimer: All product specifications and data are subject to change without notice and believed to be correct at the time of publication. MAD Design Group (MDG), its affiliates, agents, and employees, and all persons acting on its or their behalf (collectively, "MAD Design Group"), disclaim any and all liability for any errors, inaccuracies or incompleteness contained herein or in any other disclosure relating to any product. MDG disclaims any and all liability arising out of the use or application of any product described herein to the maximum extent permitted by law. The product specifications do not expand or otherwise modify MDG's terms and conditions of purchase, including but not limited to the warranty expressed therein, which apply to these products. No license, express or implied, by estoppel or otherwise, to any intellectual property rights is granted by this document or by any conduct of MDG. Customers using or selling MDG products not expressly indicated for use in such applications do so entirely at their own risk and agree to fully indemnify MDG for any damages arising or resulting from such use or sale. Please contact authorised personnel from MDG to obtain written terms and conditions regarding products designed for such applications. Images are indicative only.

Mix 600 Specifications

Fashioned from weather-resistant concrete, the portable Mix 600 (little sister to the Mix 850), is the perfect addition to myriad outdoor environments.

Burner Ventilation and Efficiency*

 Dimensions L x W x H mm/in	 Compatible Burner	 Fuel Capacity	 Heats on Average (Indoors)	 Thermal Output Net (MAX)	 Approx. Burn Time	 Minimum Room Size
600 x 600 x 229 23.6 x 23.6 x 9	AB3	2.5 L [0.7 Gals]	Over 20 m ² [215 ft ²]	6.14 MJ/h 5,800 BTU/h 1.7 kW	8 - 11 hours	40 m ³ [1,413 ft ³]

Application	Outdoor
Surround Colours	 Natural ESF.O.MX6.NA  Graphite ESF.O.MX6.GH  Bone ESF.O.MX6.BO
Burner Colours	 Stainless Steel  Black
Materials	Fluid Concrete Surround, Grade 304 Stainless Steel Burner, with optional Black Ceramic Coating
Approx. Weight	23.4kg [51.6lbs] Weight includes burner and black glass charcoal.
Fuel Type	e-NRG Bioethanol / e-NRG.com

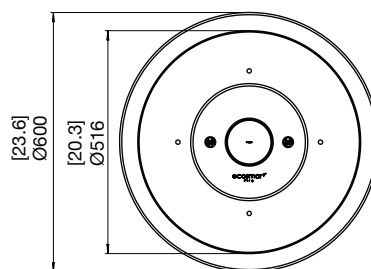
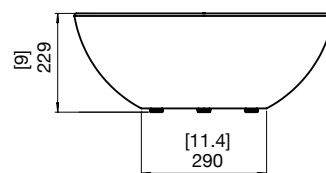

*These values are indicative only and may vary depending on the model purchased, installation, and the seasonal resource used to manufacture e-NRG.

This model comes with fixing brackets for permanently locating into a fixed position.

This model complies with existing standards in the USA and Australia. O-TL listed to UL 1370 and ACCC Safety Mandate compliant.

FOR MORE INFORMATION PLEASE REFERENCE THE CLEARANCE & INSTALLATION MANUAL

Disclaimer: All product specifications and data are subject to change without notice and believed to be correct at the time of publication. MAD Design Group (MDG), its affiliates, agents, and employees, and all persons acting on its or their behalf (collectively, "MAD Design Group"), disclaim any and all liability for any errors, inaccuracies or incompleteness contained herein or in any other disclosure relating to any product. MDG disclaims any and all liability arising out of the use or application of any product described herein or of any information provided herein to the maximum extent permitted by law. The product specifications do not expand or otherwise modify MDG's terms and conditions of purchase, including but not limited to the warranty expressed therein, which apply to these products. No license, express or implied, by estoppel or otherwise, to any intellectual property rights is granted by this document or by any conduct of MDG. Customers using or selling MDG products not expressly indicated for use in such applications do so entirely at their own risk and agree to fully indemnify MDG for any damages arising or resulting from such use or sale. Please contact authorised personnel from MDG to obtain written terms and conditions regarding products designed for such applications. Images are indicative only.