

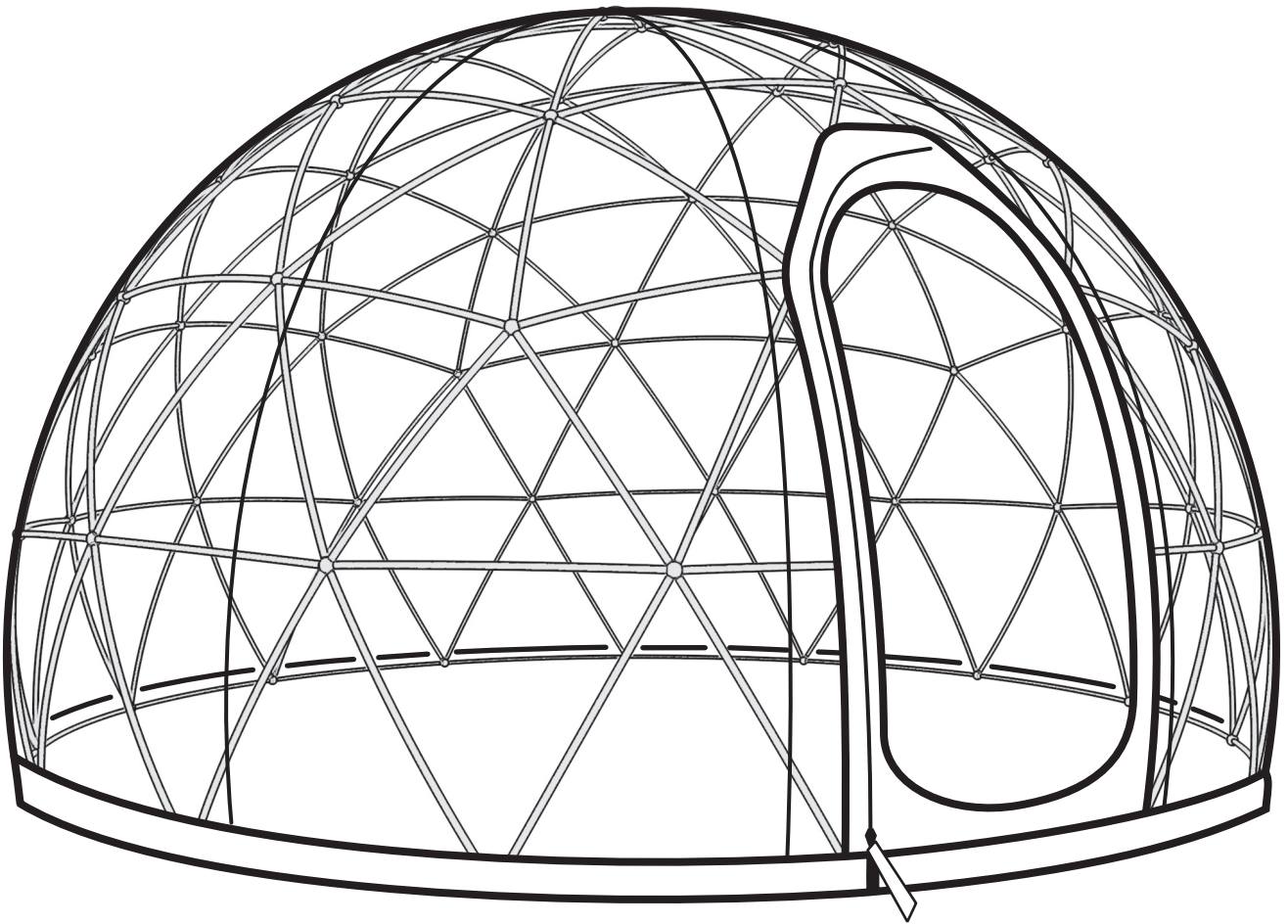











IGLOO **POD**









INSTALLATION & USER'S GUIDE

PART LIST

STRUTS

											
A	B	C	D	E	F	G	H	I	J	K	L
30x	42x	64x	4x	8x	8x	2x	2x	2x	2x	1x	2x

JOINTS

1	2	3	4	5	6	7
						
2x	13x	6x	37x	2x	2x	2x

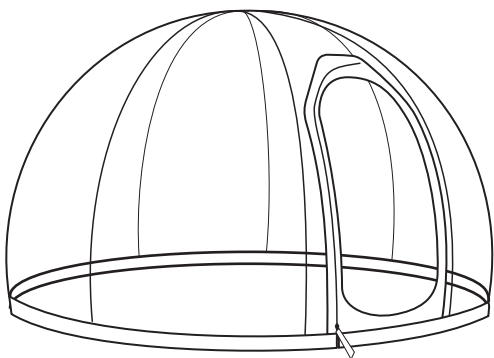

1x
TRANSPARENT COVER

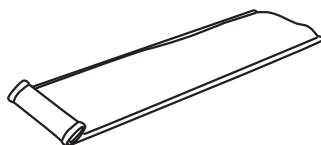

14x
BASE WEIGHT BAGS



40x
SCREWS & RAWLPLUGS



28x
VELCRO STRAPS



20x
ANCHOR CLAMPS

For your safety:



DANGEROUS for children

- Keep the packaging material out of the reach of children. The plastic bags and protective films are not toys. Make sure that children do not pull them over their heads, and do not to allow them to swallow any parts. Risk of suffocation!
- Keep infants away from the product as they might try to pull themselves up on it or climb onto it.

DANGER – due to fire / lighting / heat

- The cover is made of non-flammable material:
 - Do not position gas/coal grill or other types of cooking devices inside or nearby the product.
 - Do not use naked flames, e.g. propane cookers, candles or oil lamps in the vicinity of the product.
 - Do not smoke inside Igloopod.
- Never light a fire, or set up a barbecue inside Igloopod! There is a risk of death due to carbon monoxide poisoning!
- Never assemble or take down Igloopod during a thunderstorm. Always evacuate Igloopod during thunderstorms or stormy weather, and look for a suitable refuge.
- Warning! When using Igloopod with the transparent cover:
 - The temperature inside Igloopod can quickly reach over +60°C in sunny weather.
 - Never leave children or pets in Igloopod unsupervised.
 - Open the door and windows early on to allow air to circulate.
- Use only outdoor type electrical components such as heating, lighting, etc...
- Do not use electrical components manufactured for indoor/household use.

CAUTION – risk of injury and material damage!

- Assemble Igloopod with at least 2 people (including yourself).
- When assembling the product, wear protective gloves, ensure that your fingers do not get caught between the struts and joints.
- Keep other people – especially children – well away from the working area when assembling the product.
- Do not put your full weight off the product. It could fall over or be damaged.
- Check from time to time whether all joint connections are tight, and press the struts in tighter if necessary.
- When placing Igloopod, make sure that there are no pointed objects on the ground, e.g. stones or branches. These can damage the cover.
- Only use the product for its intended purpose and do not overload it. For example, do not hang any objects on any part of the frame.
- **Please note the important information regarding stability!**

Intended use:

The product is designed and suitable for outdoor use.

The product is designed for household use and can be used commercially* as well.

Cleaning and storage:

- Wipe off the cover with a moist microfiber cloth. For stubborn stains on the tent material, use a commercially available cleaning product designed for tents.
- Do not use any abrasive or caustic cleaning products or hard brushes, etc. for cleaning. The cover is not suitable for machine washing, or drycleaning, drying in a tumble dryer, or ironing.
- Check the cover regularly for damage and leaks. Tears and holes are best patched with appropriate material available from specialist retailers.
- Should you wish to disassemble and store Igloopod: Clean all parts thoroughly before folding up, packing up and storing Igloopod.
- You can keep the struts in the previously emptied sandbags.
- Store Igloopod in a dry, cool, well-ventilated place protected from frost. Avoid direct sunlight and sources of heat.
- Weather and sunlight cause Igloopod's material to age over time. This may lead to color changes, and to material fatigue over time. Therefore, store Igloopod in a sheltered place when it is not in use.

Information regarding stability:

- Always assemble the product on a leveled, non-sloping surface.
- Choose a place that is as sheltered from wind as possible. Always secure Igloopod with the supplied sandbags and/or clamps around its edge. Fill the sandbags completely with fine, dry sand. Carefully fix the cover to the frame with the Velcro® straps.
- Igloopod is wind-resistant (Precondition: Igloopod is secured with sandbags and/or clamps as described; the door and windows are closed.) up to wind strength 6 (Beaufort scale = approx. 50 km/h). At wind speeds higher than wind strength 7 (Beaufort scale, storm/hurricane warning), remove the cover.
- ALWAYS USE YOUR ANCHORAGE KIT! Fully utilizing the Anchorage kit is vital to maximize the Igloopod's wind resistance. Please do NOT skip the installation of the ALL Metal Clamps and Screws, and ALL the 14 Weight bags.
- The transparent cover is not designed for outdoor use throughout the year. It can withstand temperatures between –20°C (outer temp.) and +60°C (inner temp.) and sunlight up to level 5 in the UV index. On sunny spring/summer days with an outdoor temperature of over +10°C the temperature inside in Igloopod can quickly get up to +60°C and above. This can damage your Igloopod, as well as your self, your animals, the furniture and plants. Monitor the temperature, if it is above +10°C outside, open the vents for the air to circulate and exit. At indoor temperatures of +60°C and over, you should remove the transparent cover. By protecting the cover from strong UV rays in this way, the service life of the cover will be prolonged.
- Disassemble Igloopod entirely, if a strong storm or hurricane is forecast.
- Igloopod can bear up to max. 40 KG of snow. You should broom off the snow regularly to prevent accumulation.

* The Igloopod can be used commercially to the Owner's discretion. However, the Owner uses the Igloopod in a commercial environment at their own risk. Any damages inflicted upon the Igloopod from third parties will nullify the Igloopod's warranty.
(I.E: A customer puncturing the Igloopod's cover with an utensil)

Dear Customer,

Keep these instructions for future reference. If you give this product to someone else, remember to pass on these assembly instructions.

We hope you will be fully satisfied with your purchase.

Read before starting !

1. Build the frame of Igloopod by following the steps of the installation diagram.
2. If the air temperature is below +10°C, keep the cover at room temperature until the assembly of the frame is completed.
3. Before installing, be sure that the ground is leveled and firm for anchorage. Soft grounds like sand, grassland, muddy surfaces, etc., may not be firm enough for using the parts provided in the anchorage kit (metal clamps and sand bags). In this case an extra foundation is recommended before installation.
4. Do not place your cover on a windy day!

See the installation video at: www.igloopod.co.uk/pages/videos

CONNECTING THE PARTS

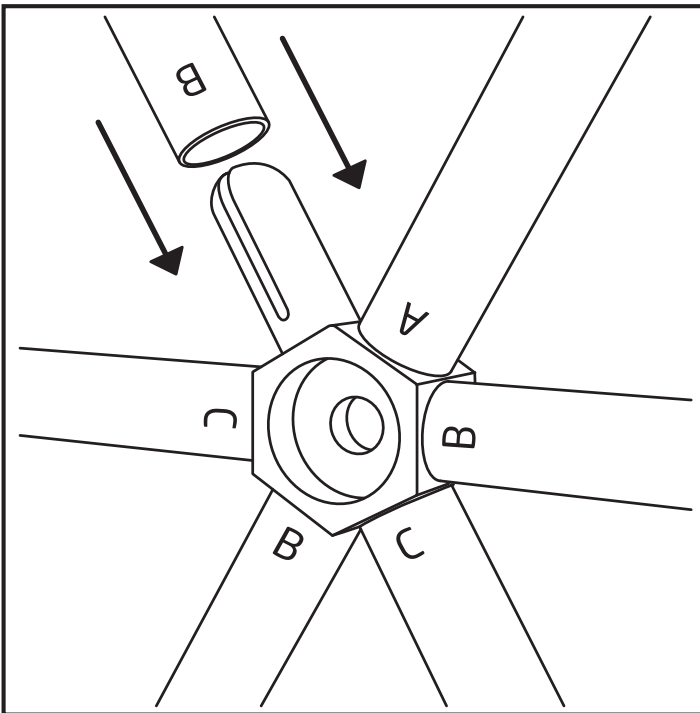

Put the joint parts in the struts tightly and be sure that they fit **completely**.

FORMING THE FRAME

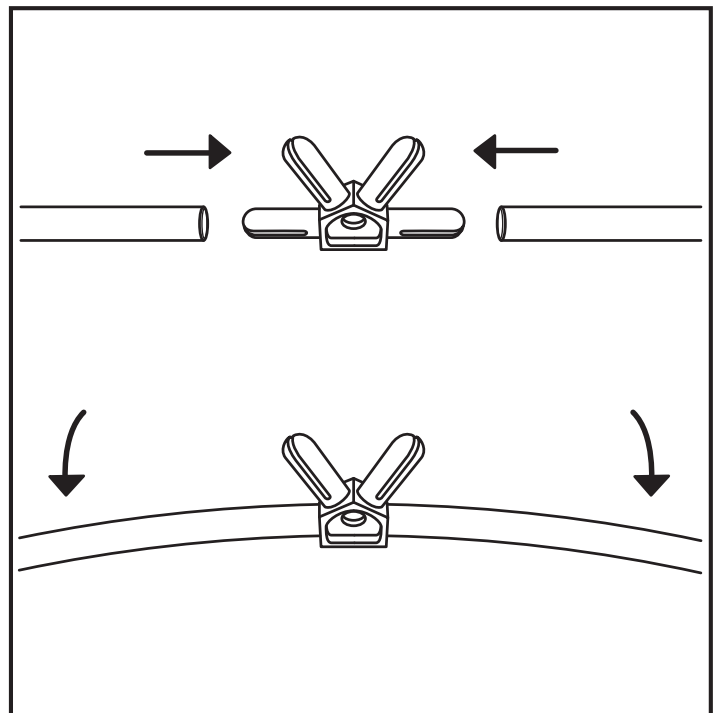

As the struts are connected, they will bend slightly to form a curved shape.

1

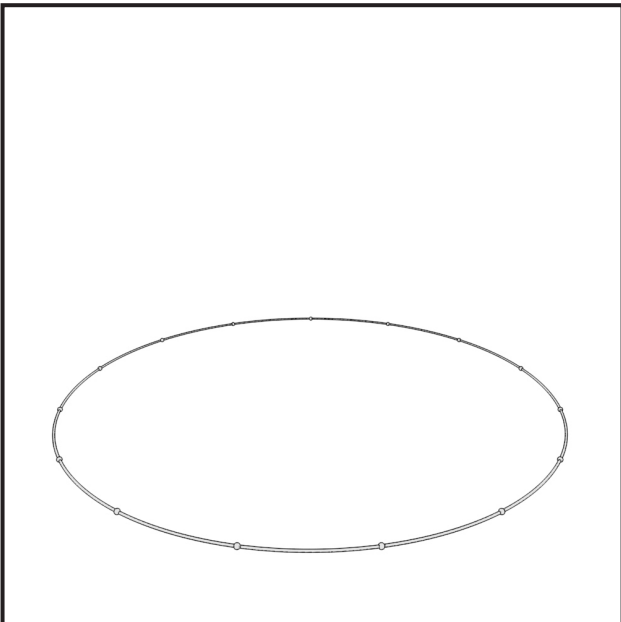
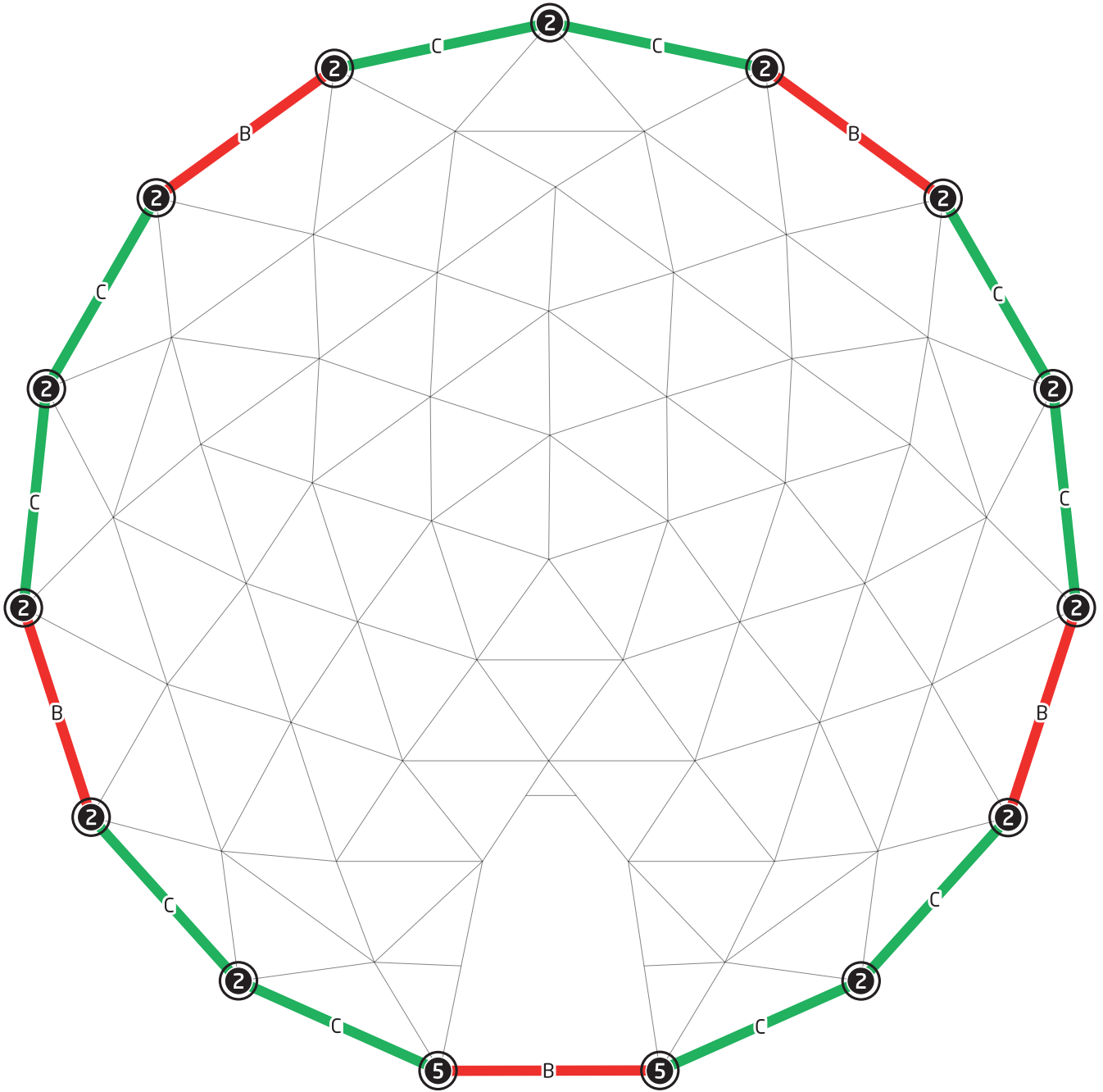

Connect the parts listed below to build a frame as shown in figure (top view) and proceed to the next step.

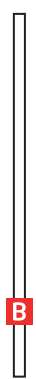

5x



10x



13x



2x



It is recommended to anchor the base circle to the ground, before the following steps. (p.21)

3

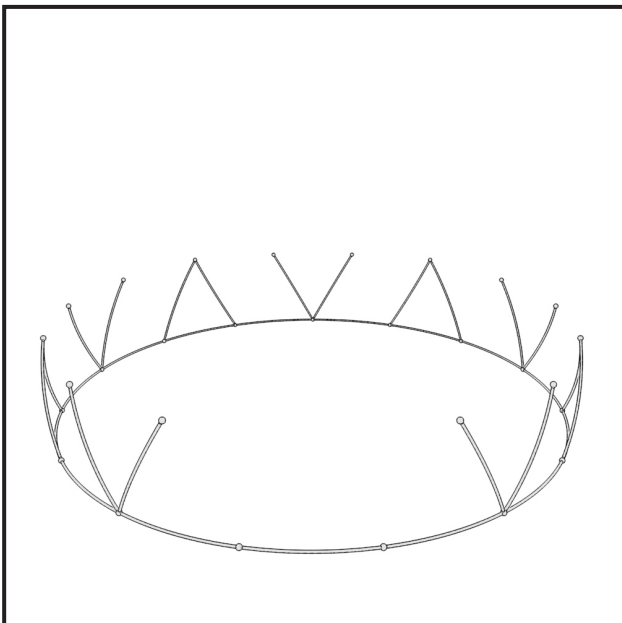
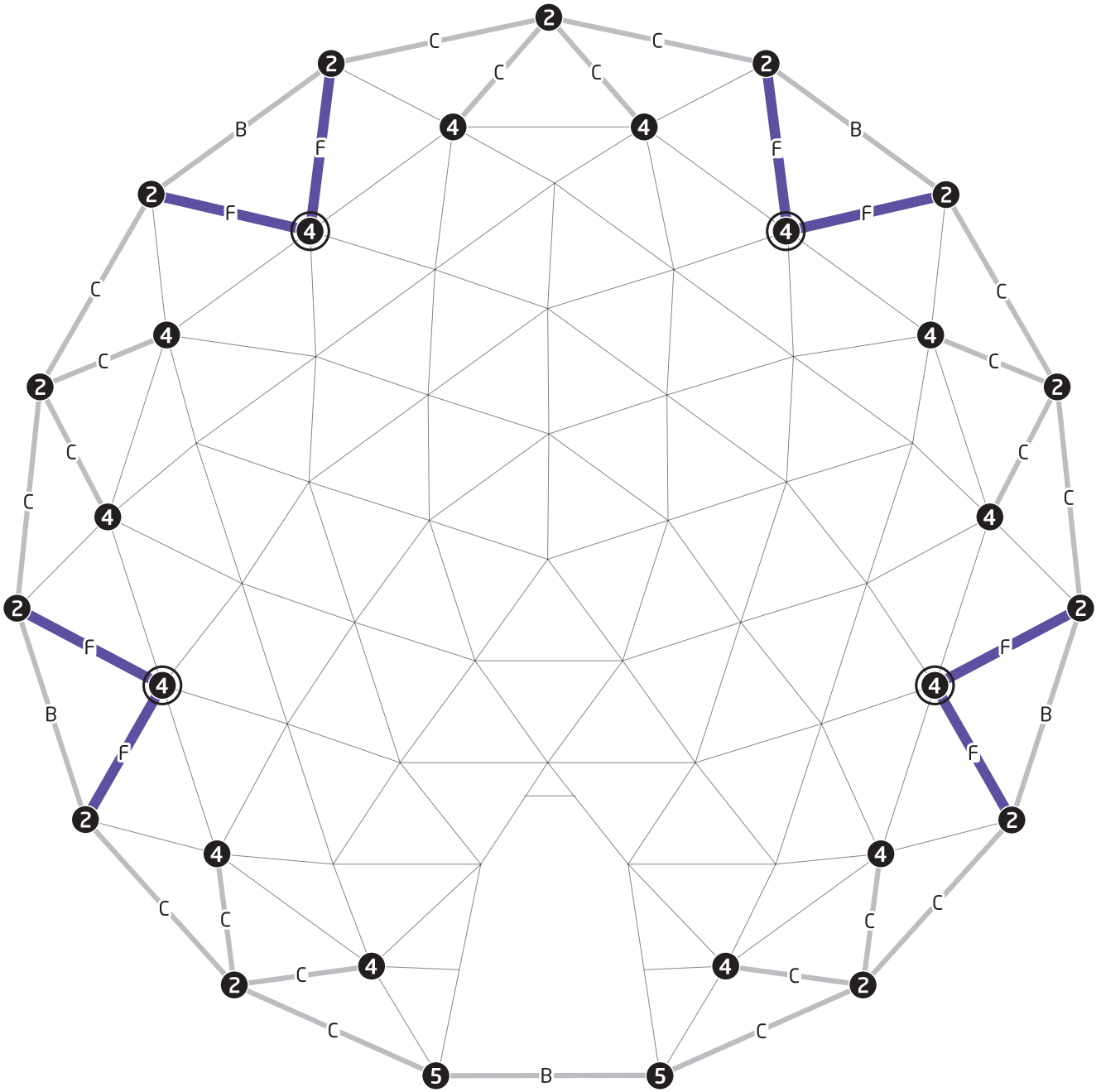

Connect the parts listed below to build a frame as shown in figure (top view) and proceed to the next step.



8x



4x

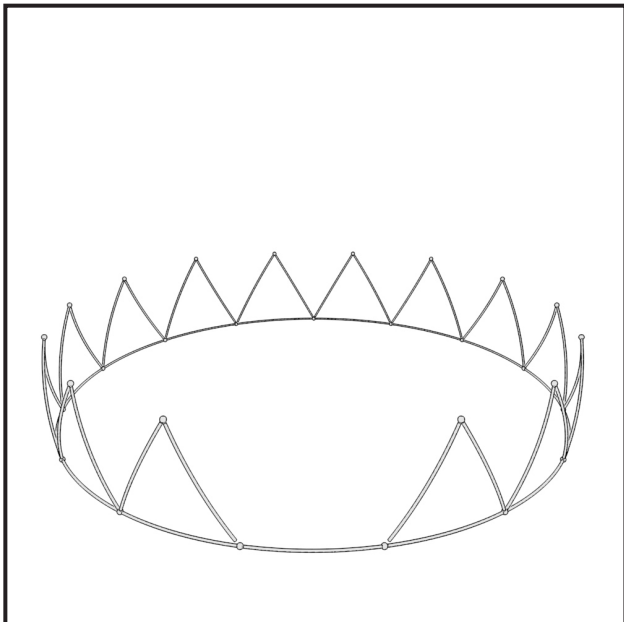
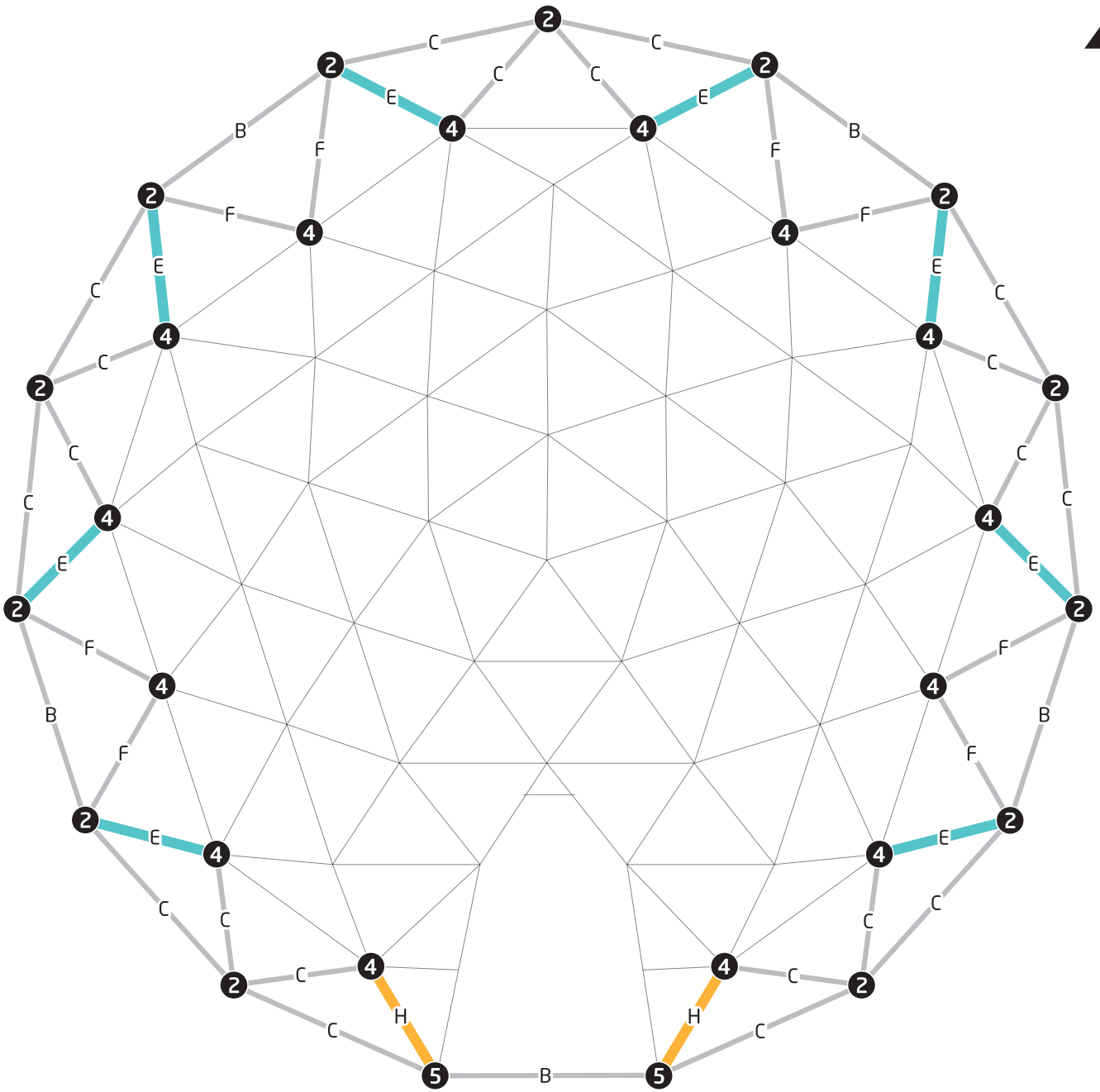

Connect the parts listed below to build a frame as shown in figure (top view) and proceed to the next step.



2x



8x

5

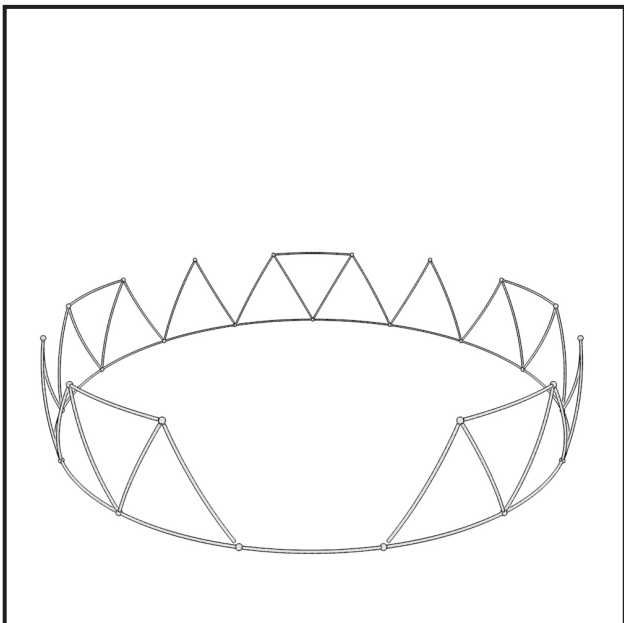
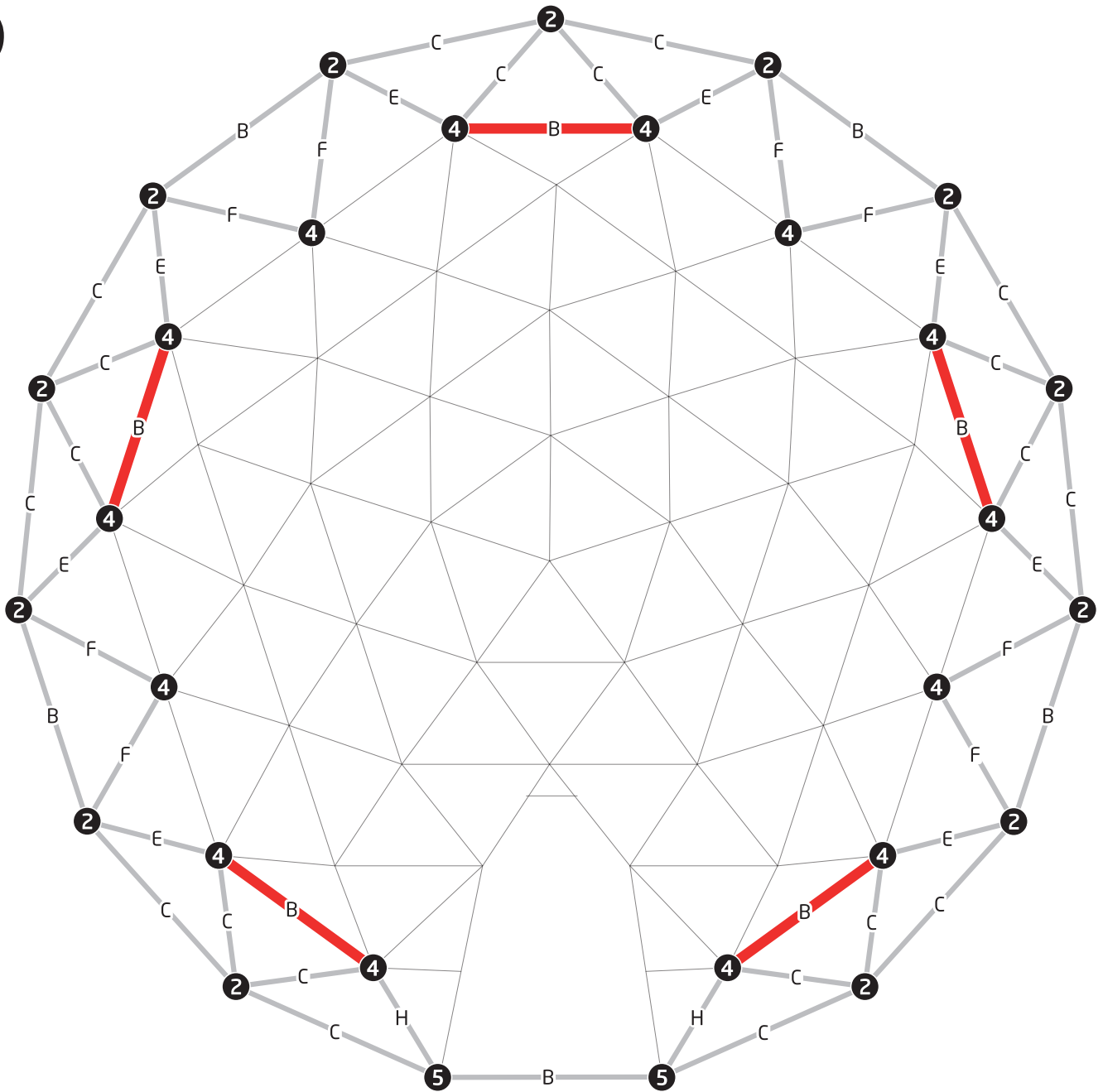

Connect the parts listed below to build a frame as shown in figure (top view) and proceed to the next step.



5x

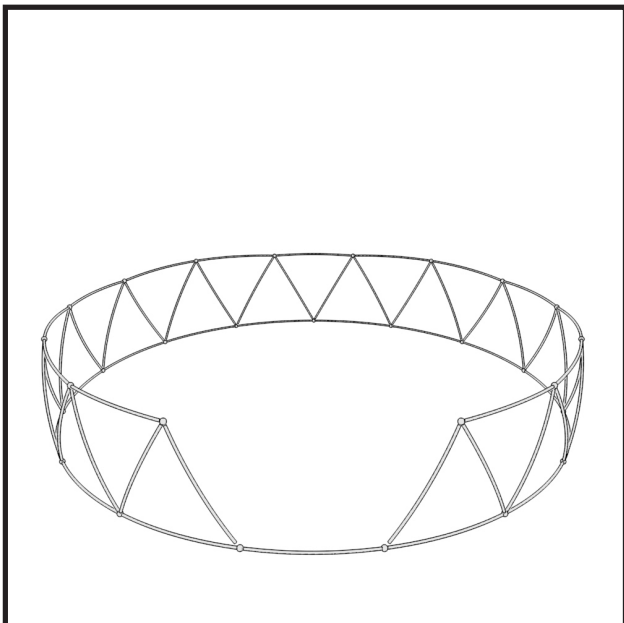
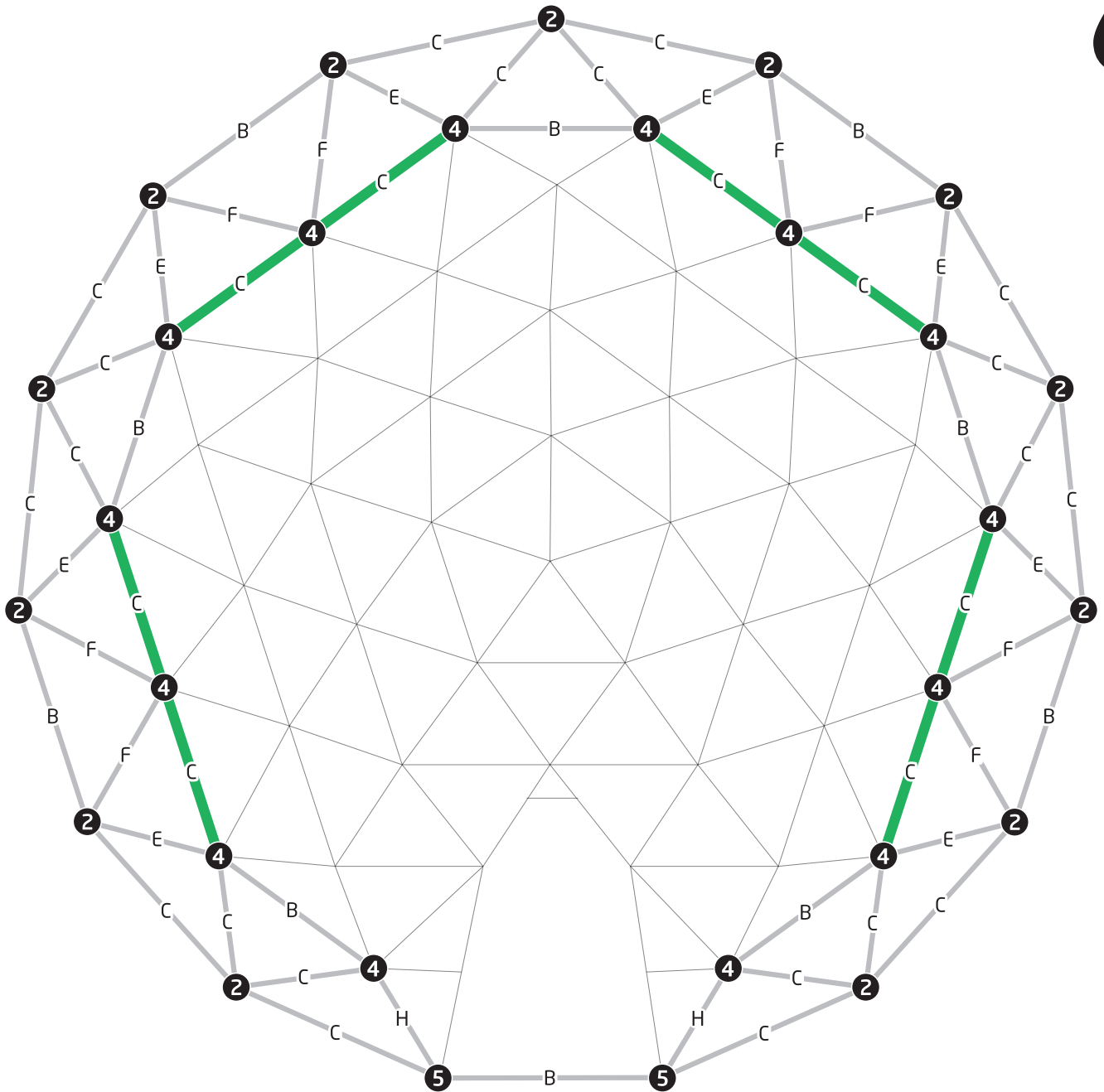

Connect the parts listed below to build a frame as shown in figure (top view) and proceed to the next step.



8x

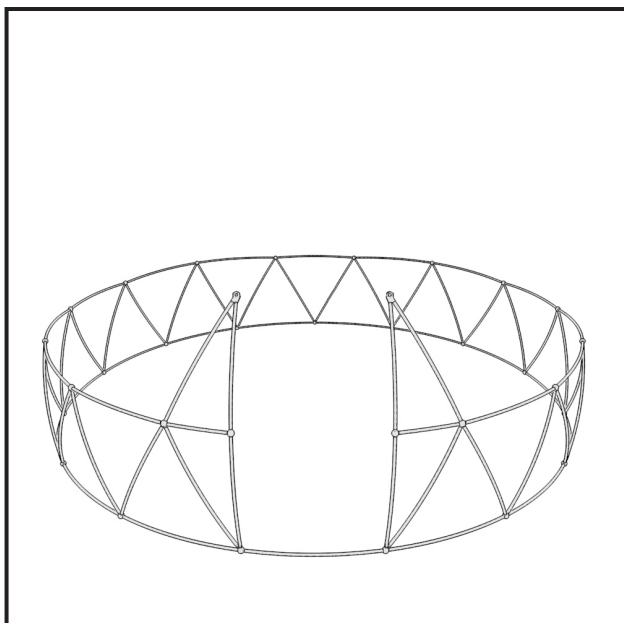
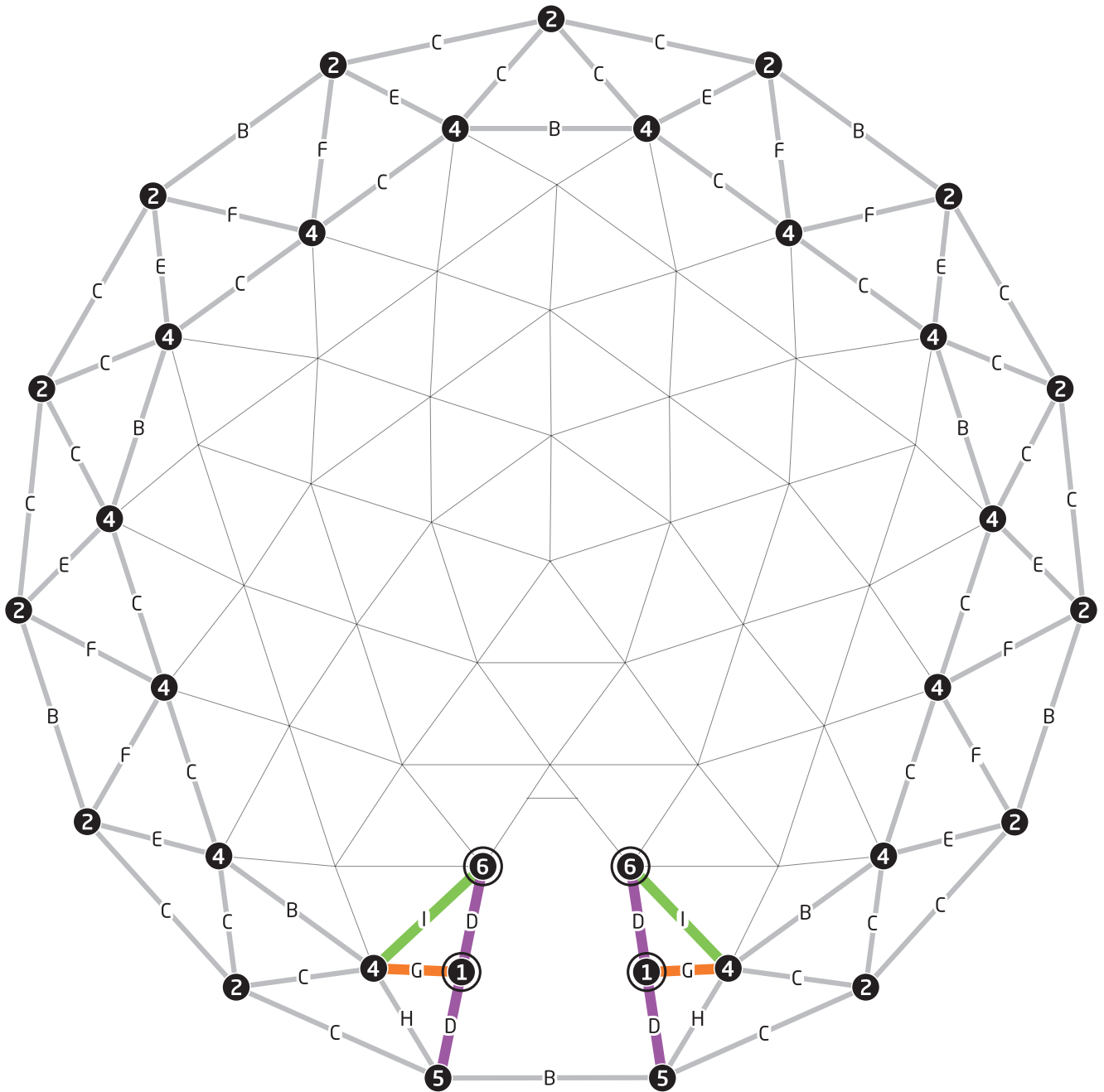

Connect the parts listed below to build a frame as shown in figure (top view) and proceed to the next step.

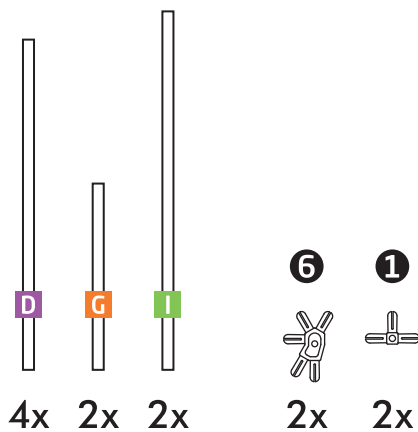

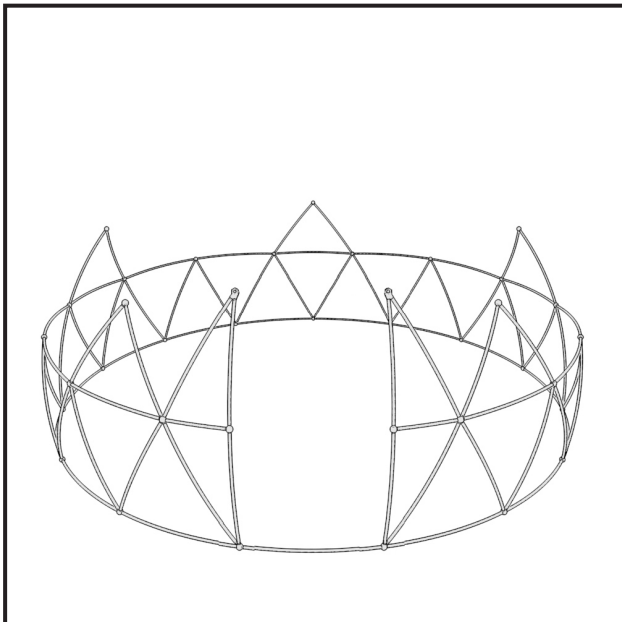
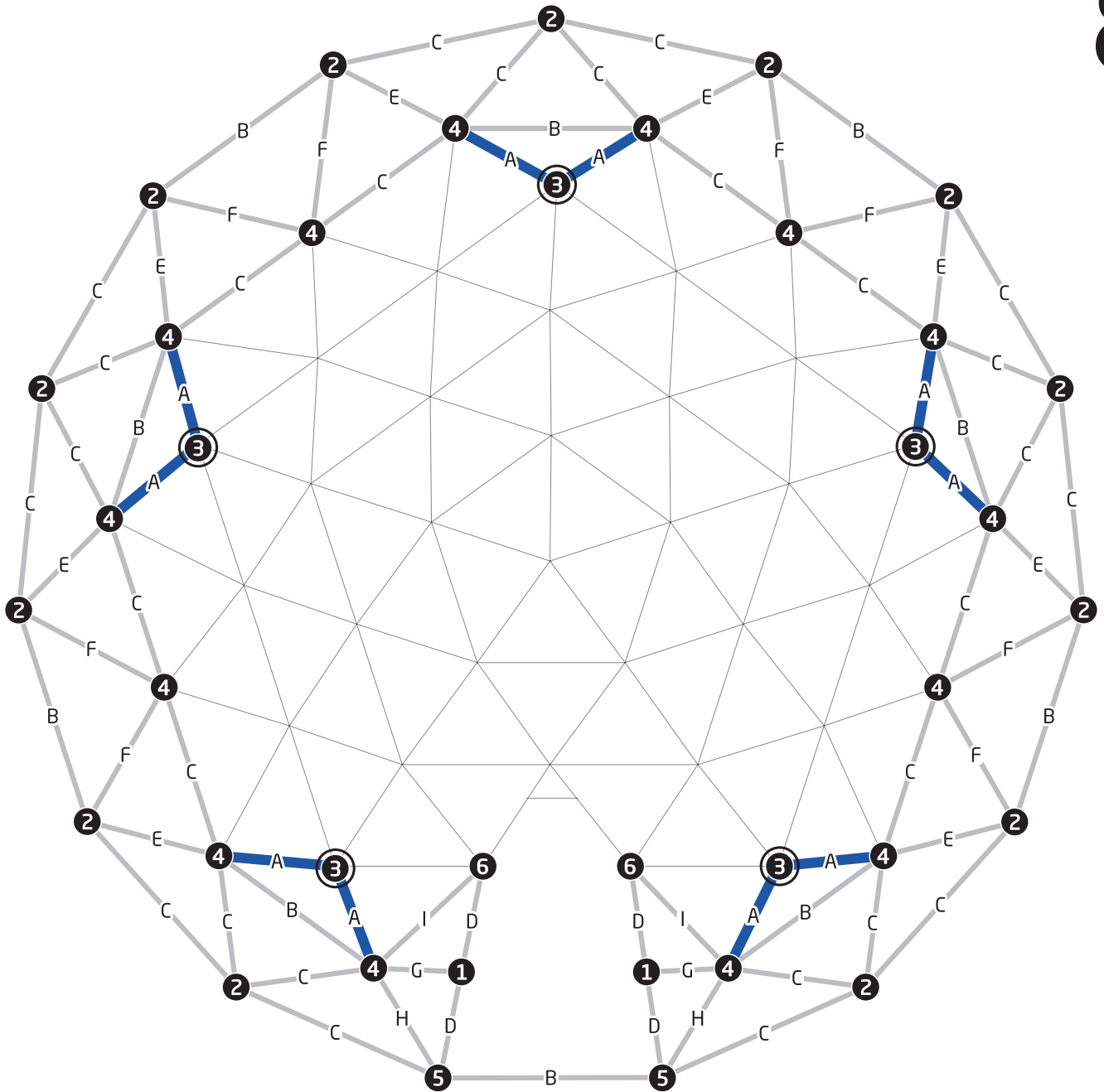

Connect the parts listed below to build a frame as shown in figure (top view) and proceed to the next step.



10x



5x

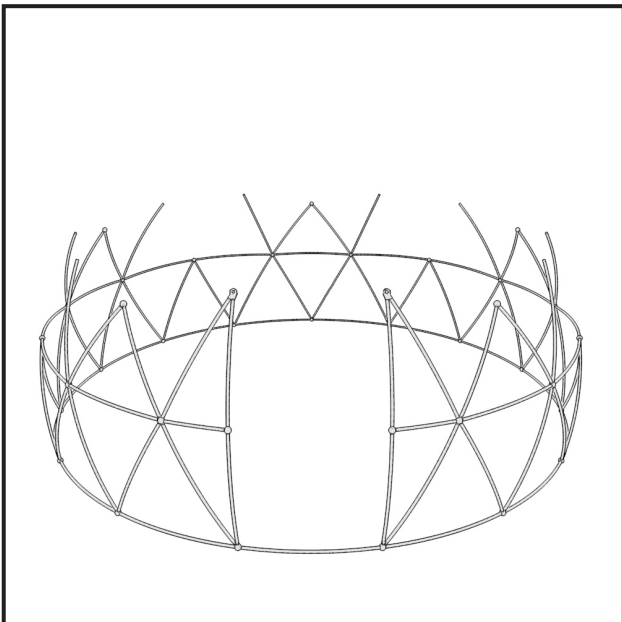
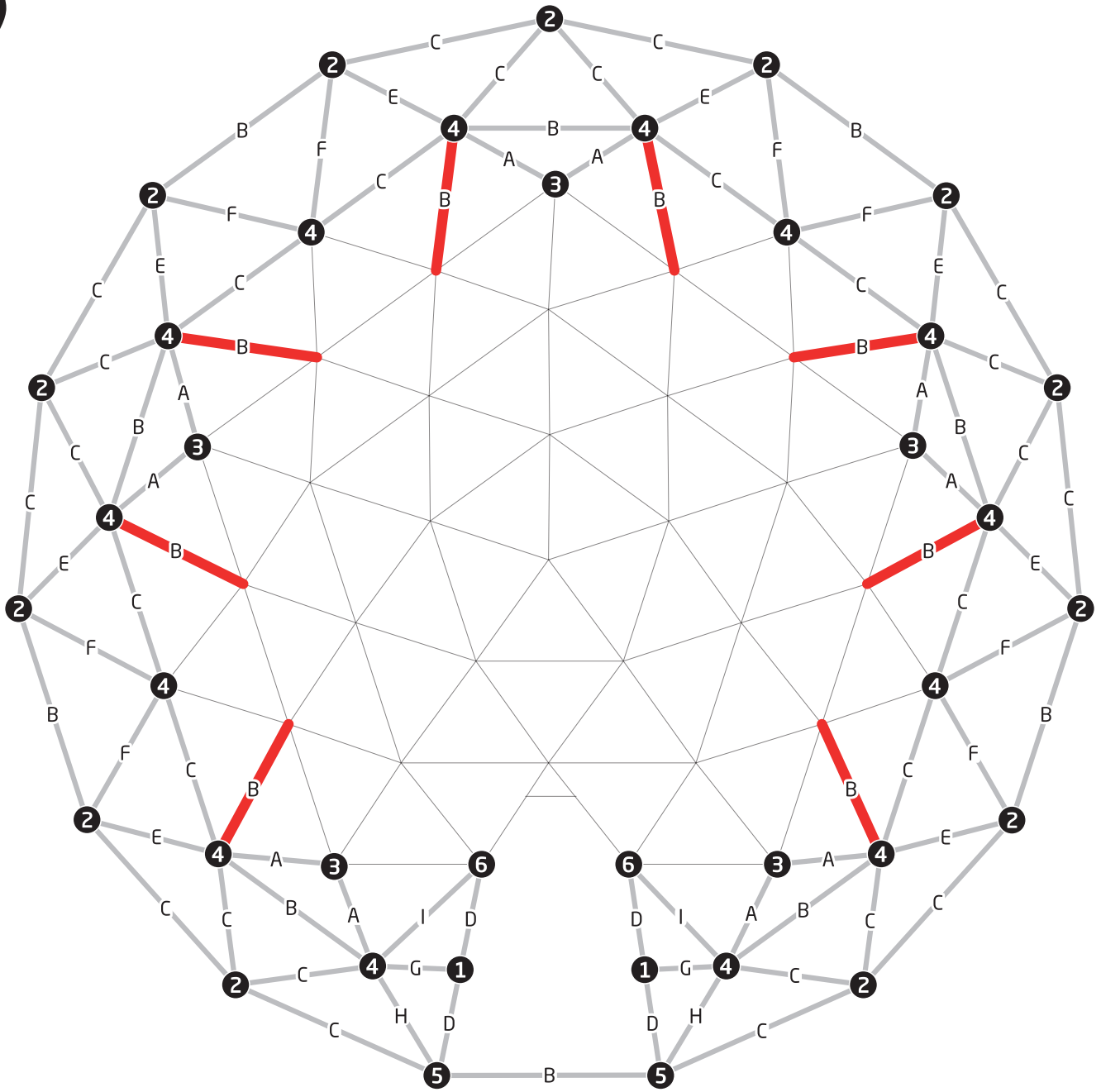

Connect the parts listed below to build a frame as shown in figure (top view) and proceed to the next step.



8x

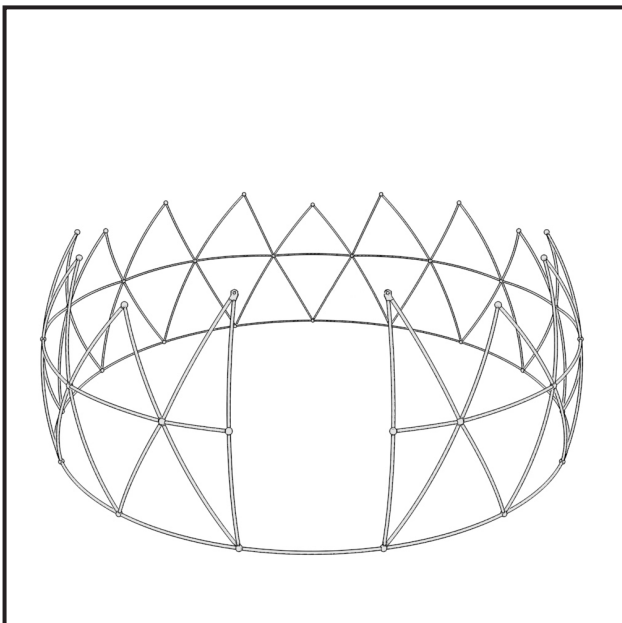
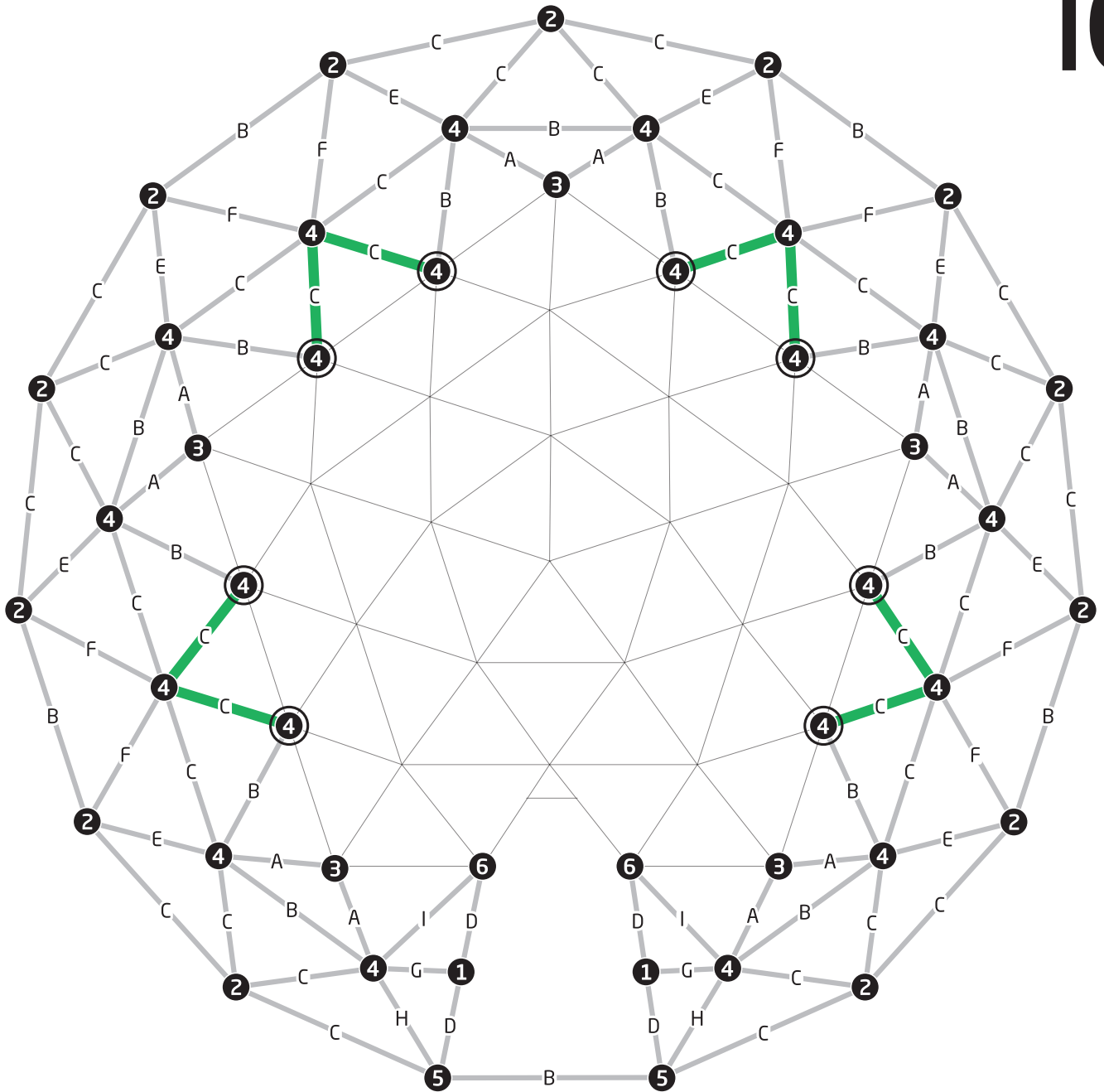

Connect the parts listed below to build a frame as shown in figure (top view) and proceed to the next step.



8x



8x

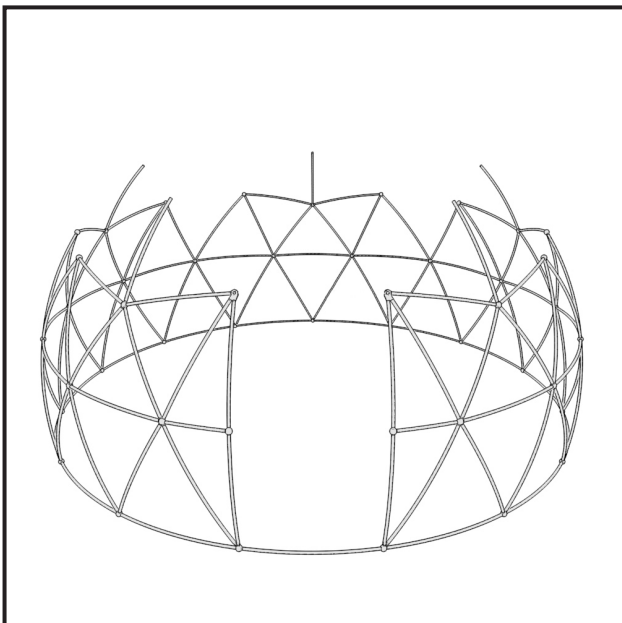
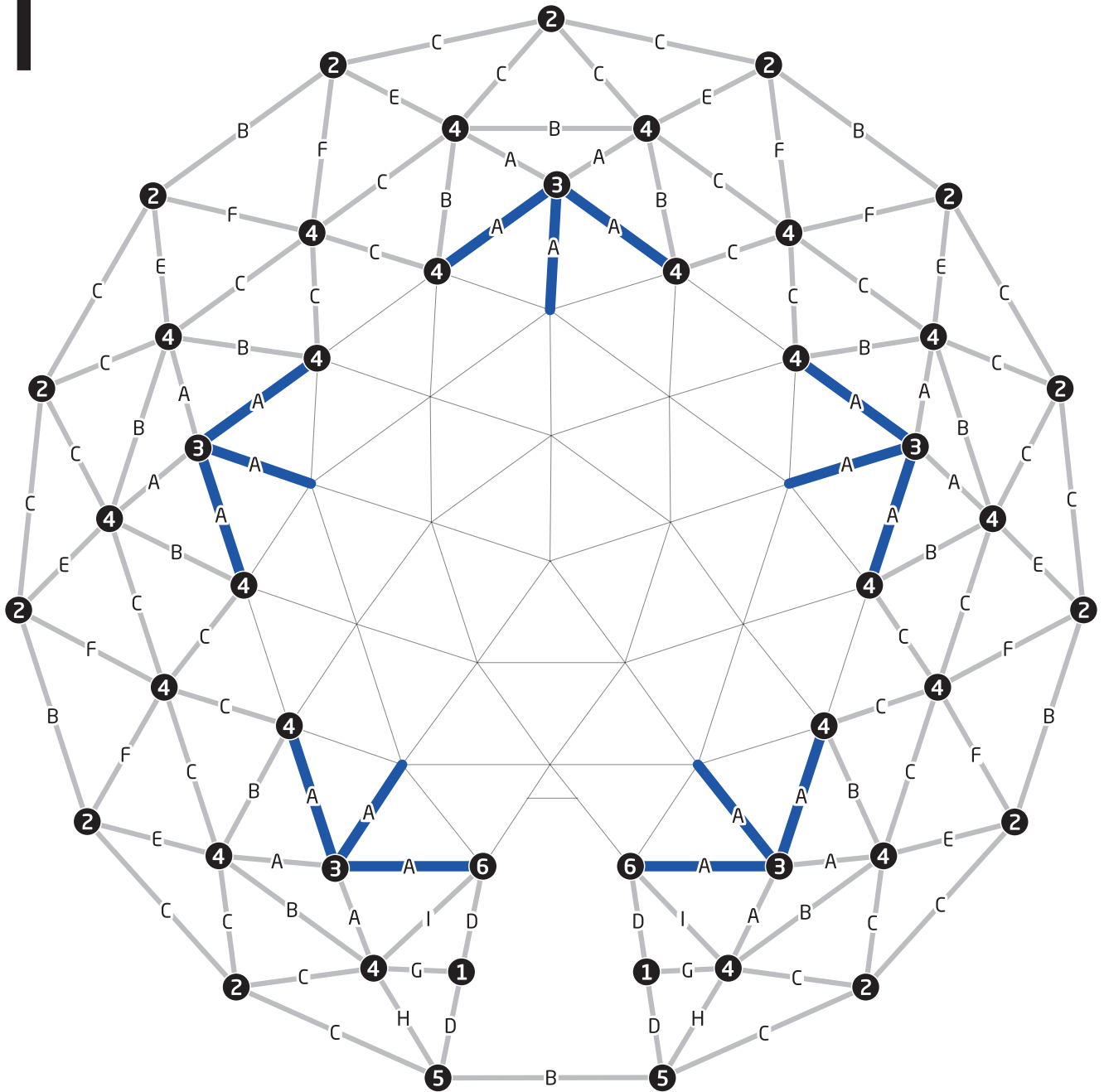

Connect the parts listed below to build a frame as shown in figure (top view) and proceed to the next step.



15x

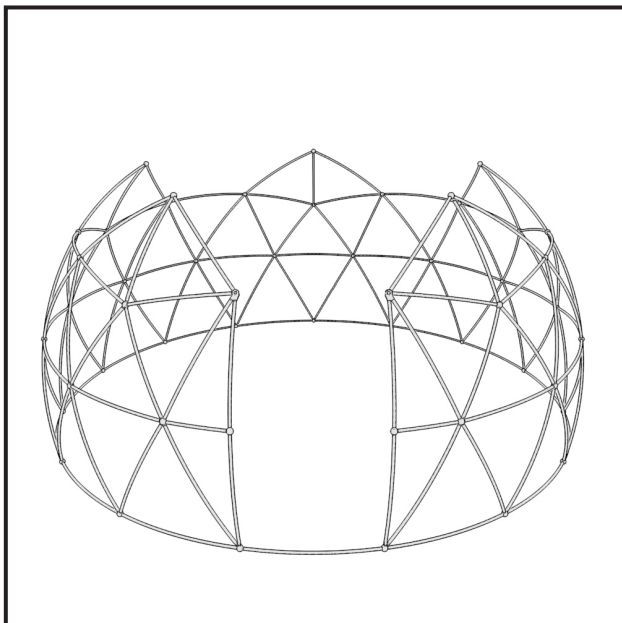
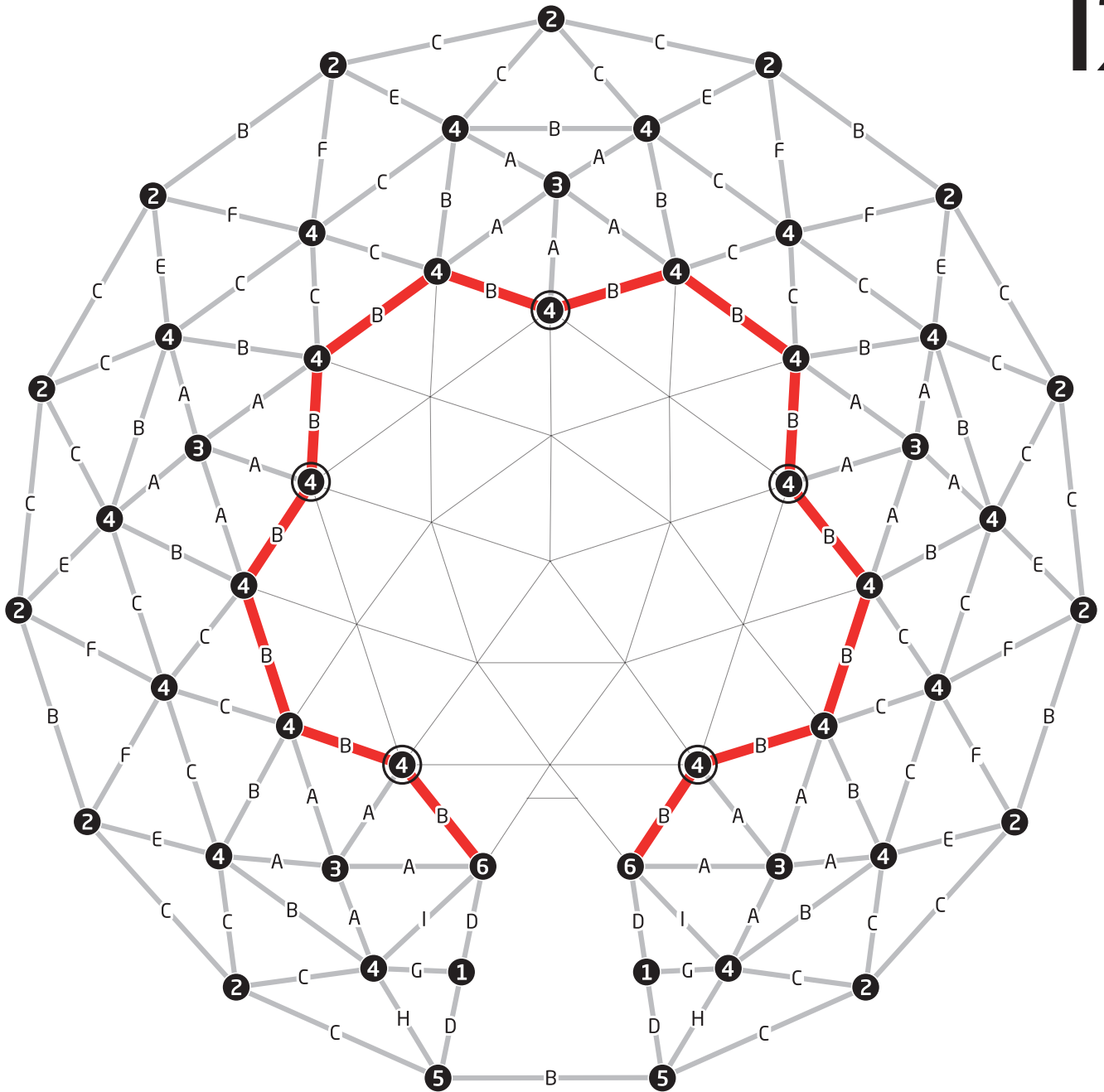

Connect the parts listed below to build a frame as shown in figure (top view) and proceed to the next step.



14x







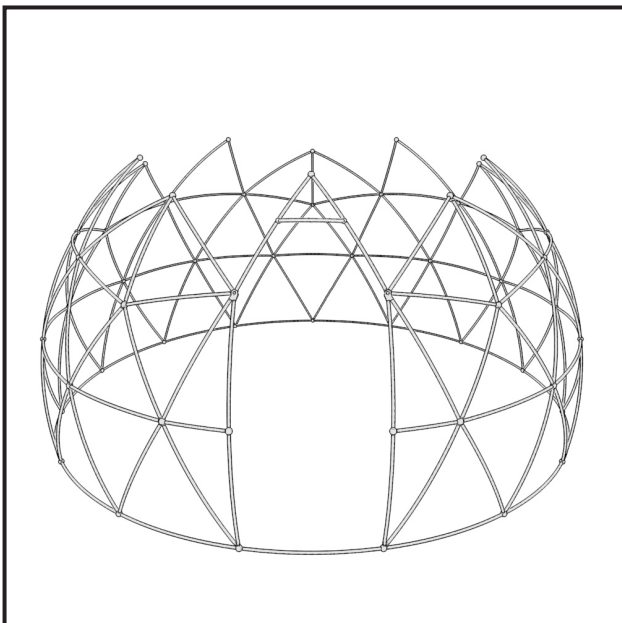
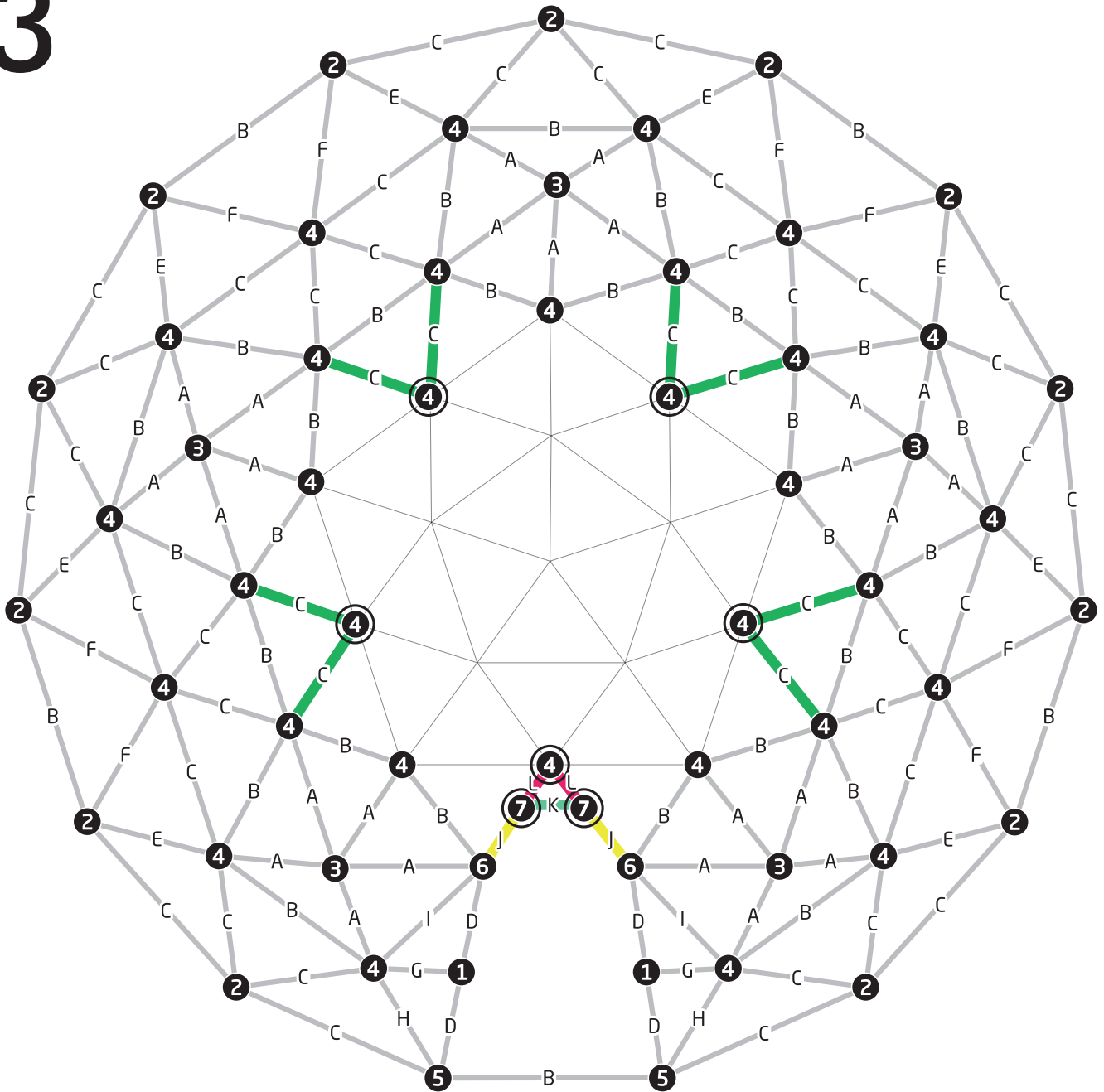

5x

13



Connect the parts listed below to build a frame as shown in figure (top view) and proceed to the next step.

- | | | | | | |
|---|---|---|---|---|---|
|  |  |  |  |  |  |
| 8x | 2x | 1x | 2x | 5x | 2x |

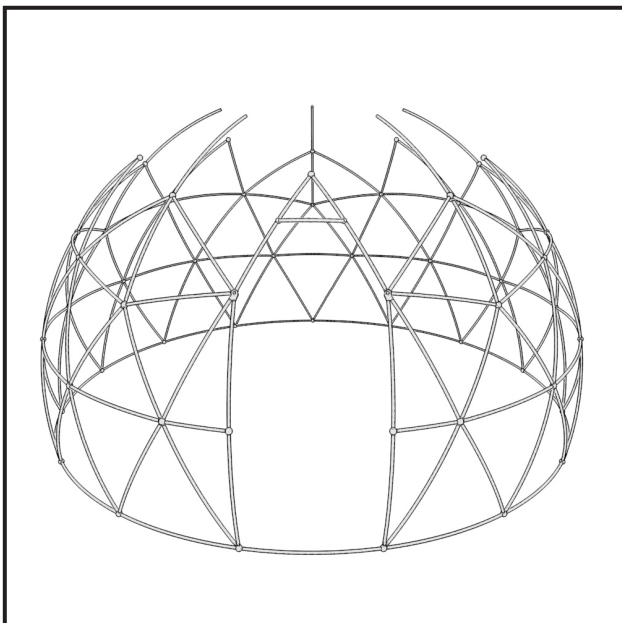
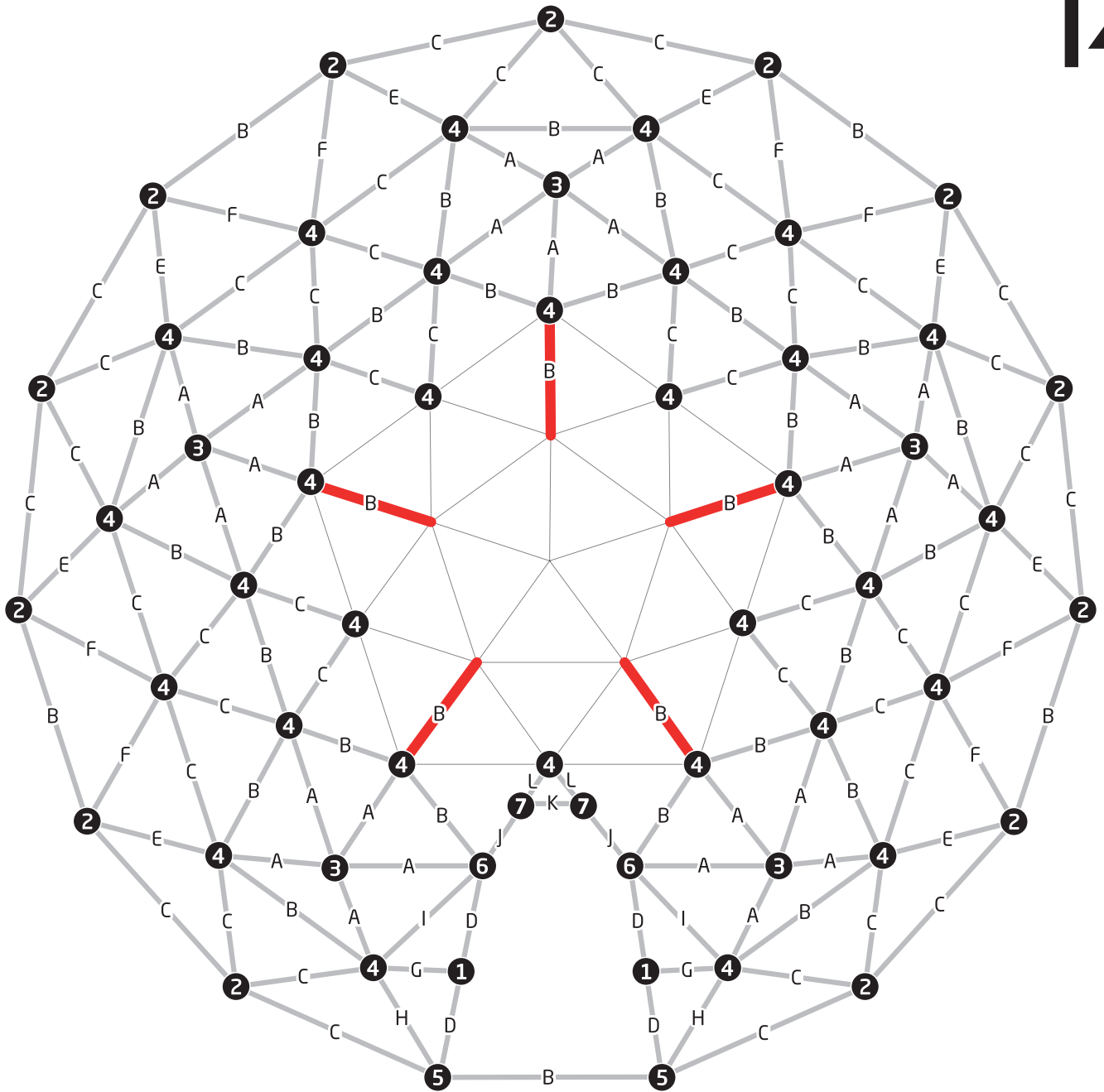

Connect the parts listed below to build a frame as shown in figure (top view) and proceed to the next step.



5x

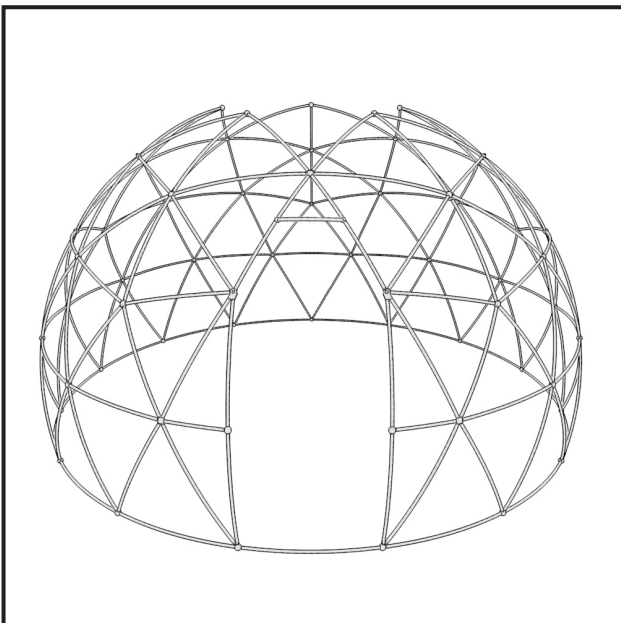
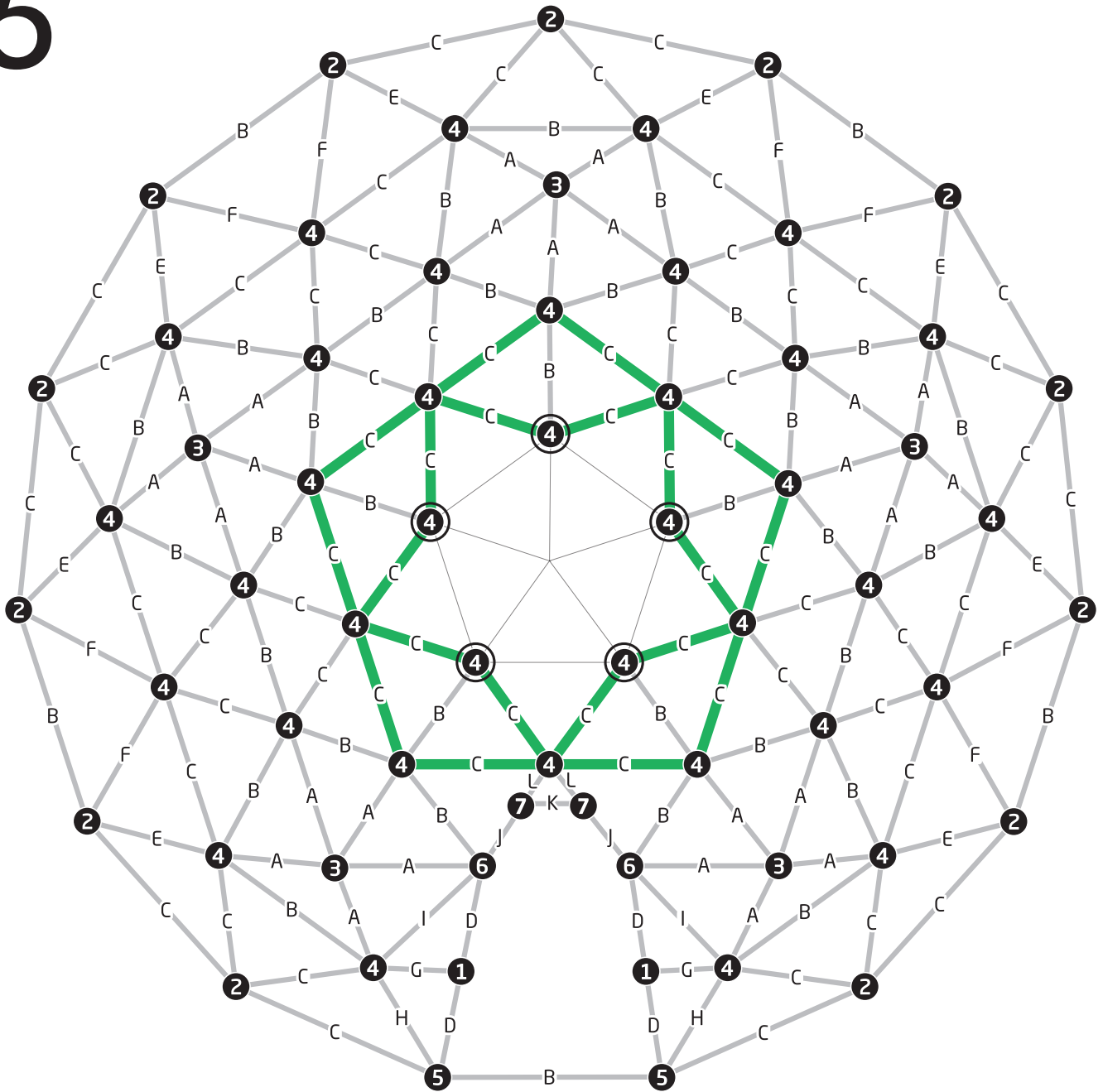

Connect the parts listed below to build a frame as shown in figure (top view) and proceed to the next step.



20x



5x

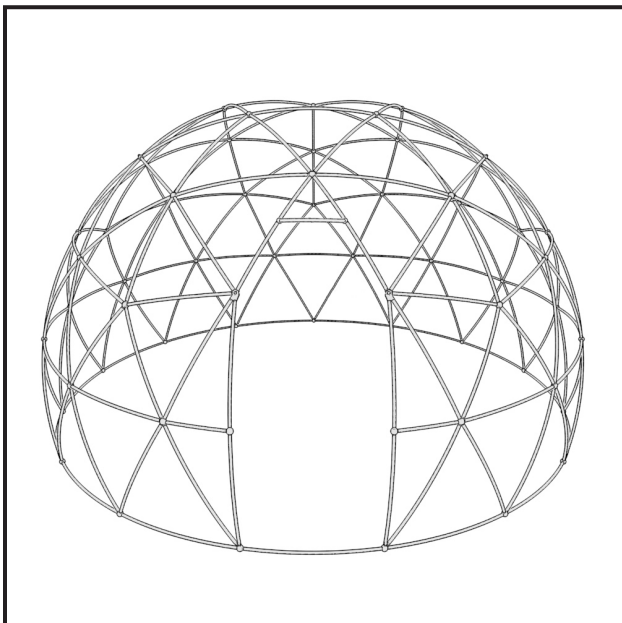
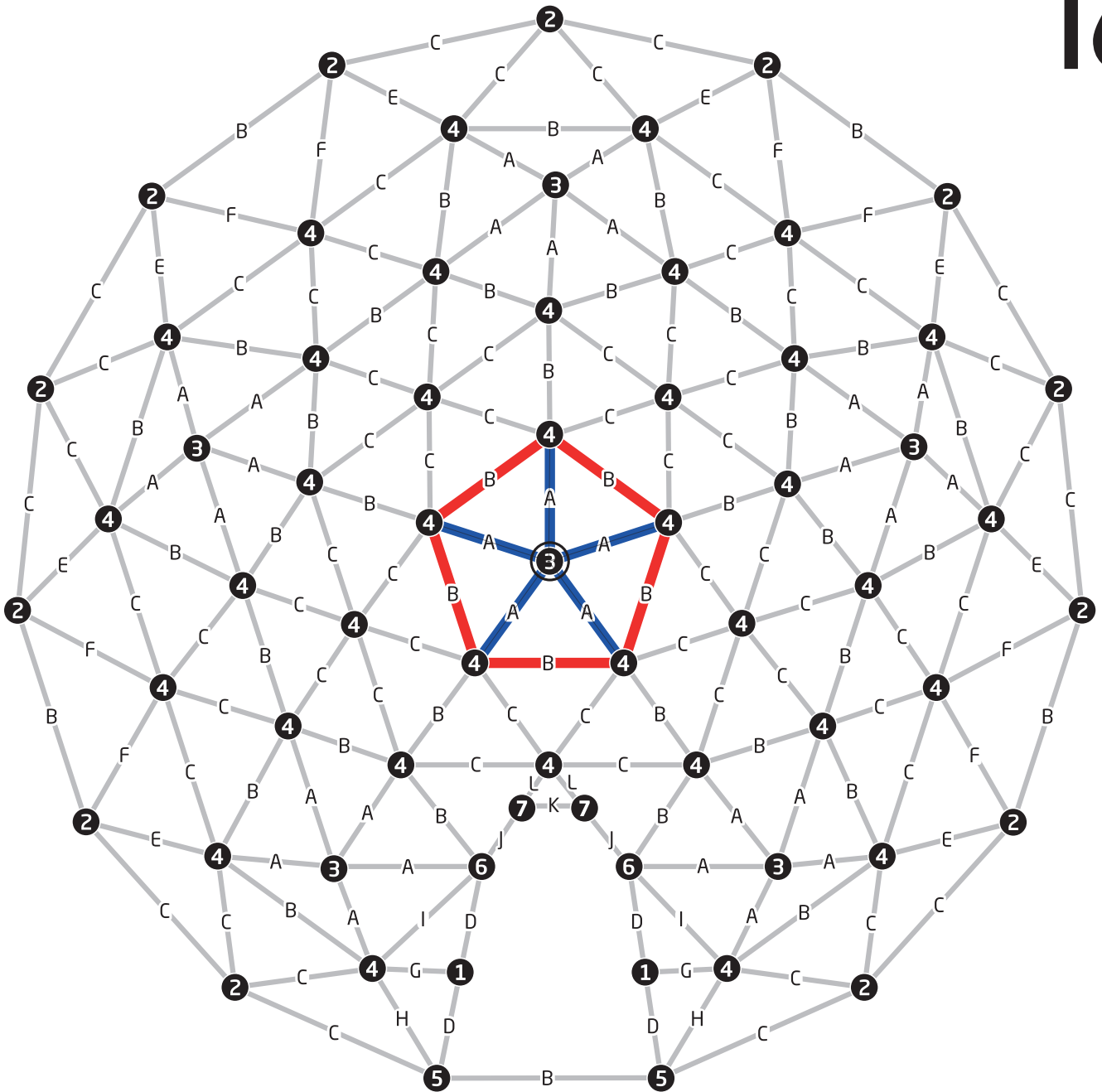

Connect the parts listed below to build a frame as shown in figure (top view) and proceed to the next step.

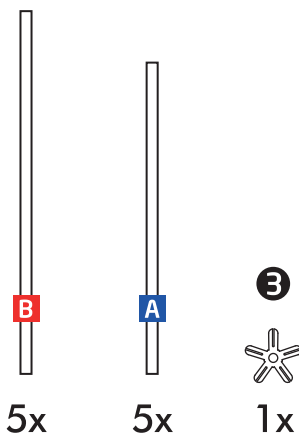

17 ANCHORAGE

Hard surfaces

Your Igloopod must be fixed to the ground at 20 points near the connection points (as shown in figure below).

- Before fixing, be sure that the ground is leveled and the base circle is not skewed to an elliptic form.
- On hard surfaces such as concrete, wood deck, etc., use the metal clamps with suitable screws.

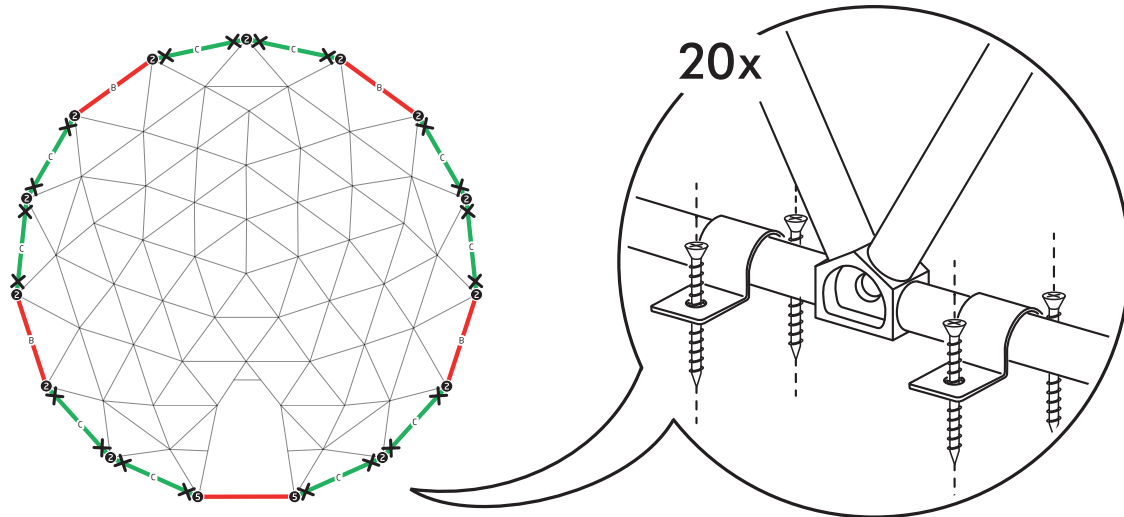

Soft grounds

- Before fixing, be sure that the ground is leveled and the base circle is not skewed to an elliptic form.
- On softer grounds like soil, lawn, etc., use **base weight bags** to fix your Igloopod to the ground.
- Igloopod may be dragged by the force of wind, turned upside down or worse, broken into pieces. To avoid wind damage to your Igloopod, it is mandatory to use the 14 base weight bags.

BASE WEIGHT BAGS

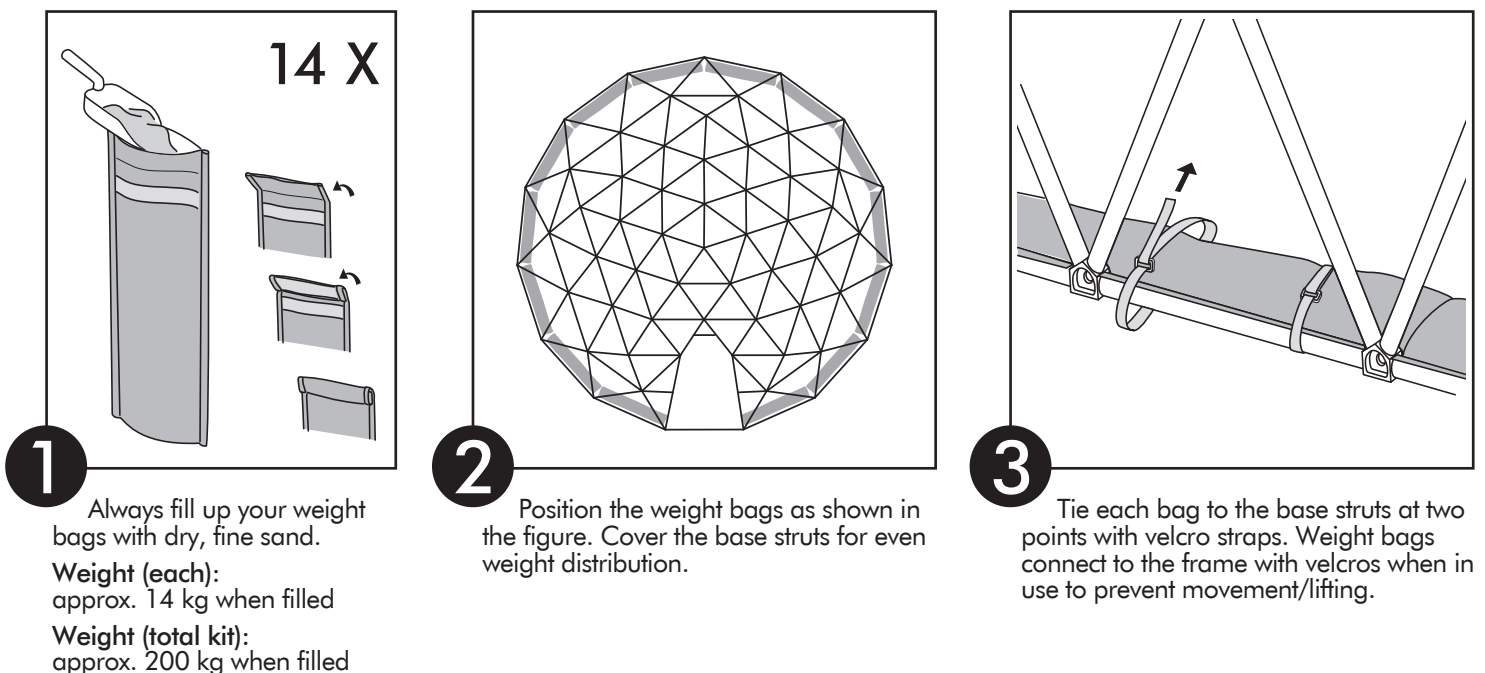



INSTALLATION OF THE COVER 18

Please make sure to properly install your cover on the structural frame of the Igloopod.
Follow all steps as dictated and apply them with **two people**.

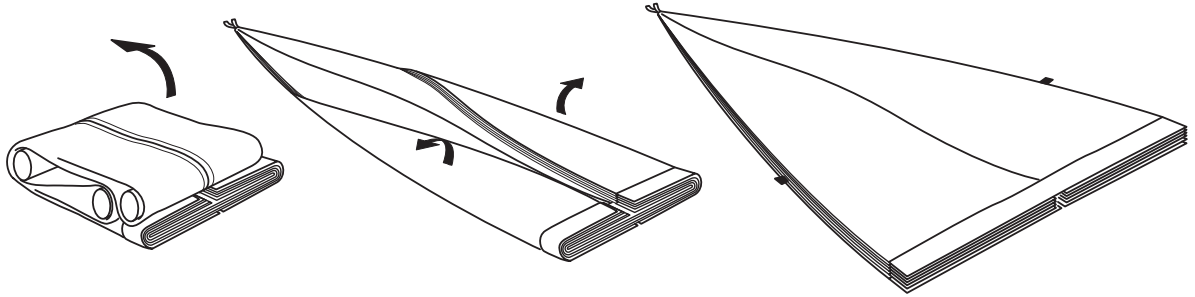

1 Unfold the cover on a clean, smooth surface as shown in the figure. Keep your cover away from sharp-edged or pointed objects (sticks, stones), cutting surfaces to prevent damage. If the outside air temperature is below +10°C, keep your cover warm at room temperature until you are ready to install.

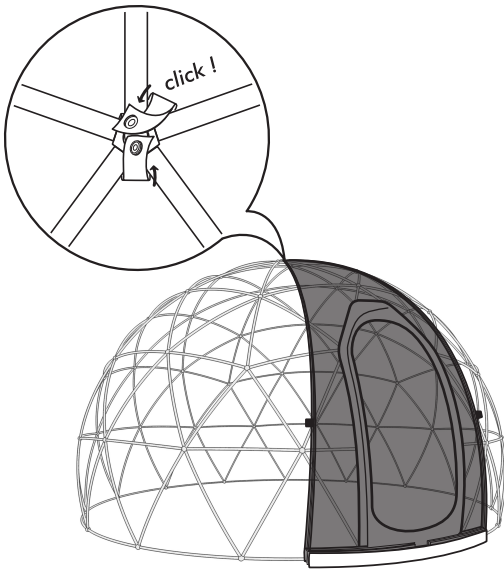

2 Lay the cover over the frame so that the zip fastener of the door is facing inside. Attach the strap on the tip of the cover to the joint on the highest point on the frame.

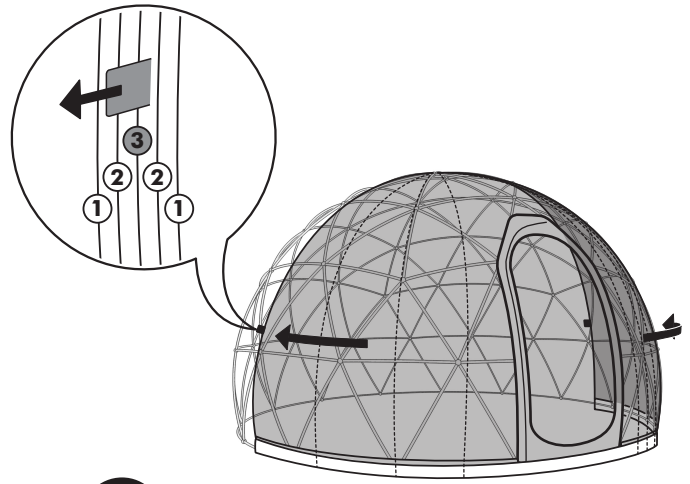

3 Pull the marked layers to both sides equally until they cover exactly half the total surface area.

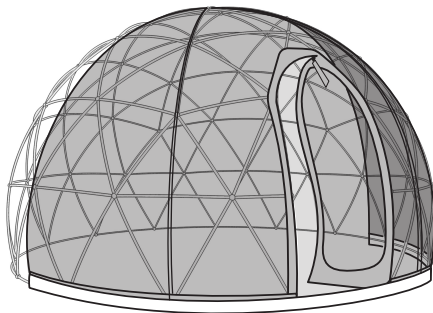

4 Open the door zipper from inside.

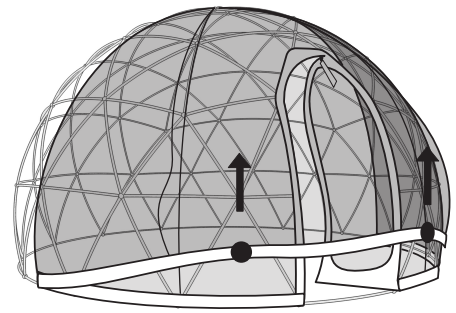

5 Hold the cover tail of the outer layer as shown in the figure.

18 INSTALLATION OF THE COVER

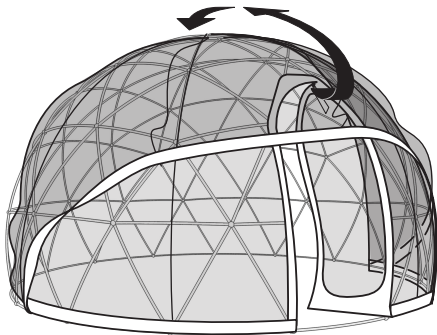

6 Lift the cover tail up and reverse it by sliding it over the frame.

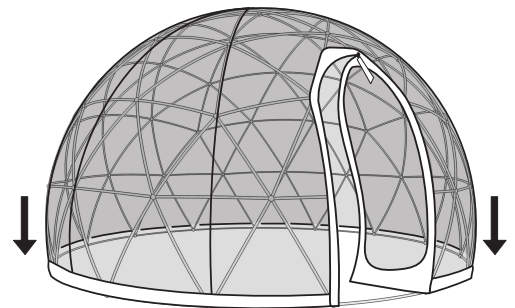

7 Hold the cover tail, gently pull even and tighten the cover.

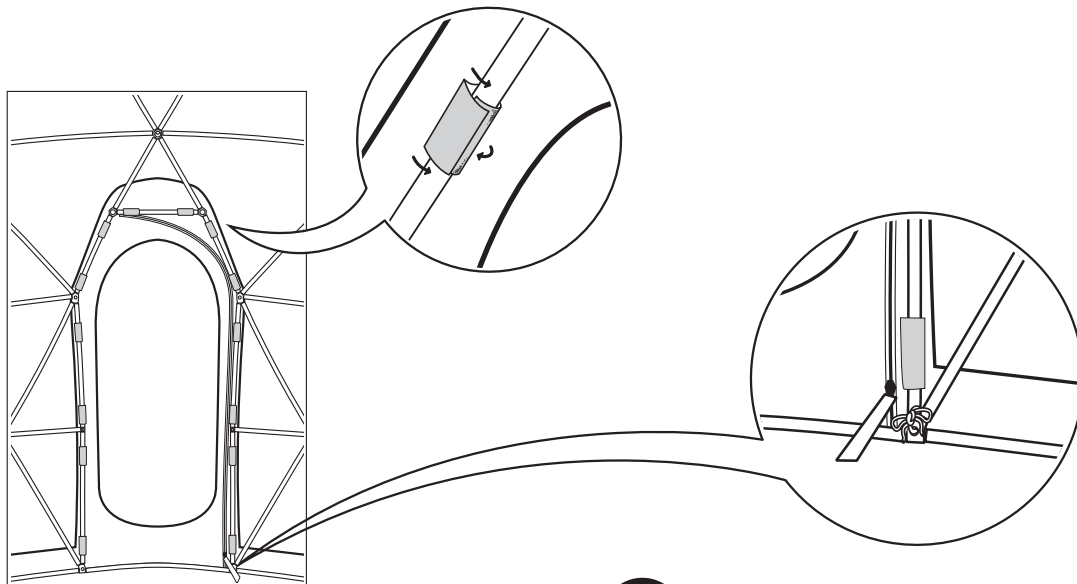

8 Wrap the Velcro straps around the struts.

9 Tie the cord at the corner edge of the cover through the hole of the joint (#5) with tight knot.

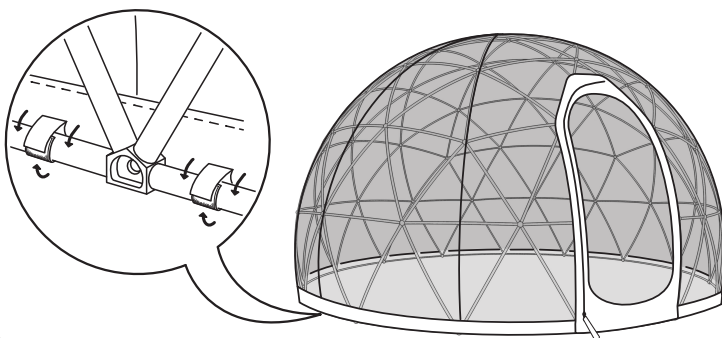

10

Close the zip fastener on the door from the inside. Align the windows of the cover with the frame. Attach all the velcro straps around the bottom edge of the cover to the base struts.

See the detailed installation videos at:
<http://igloopod.co.uk/pages/videos>



WARNING

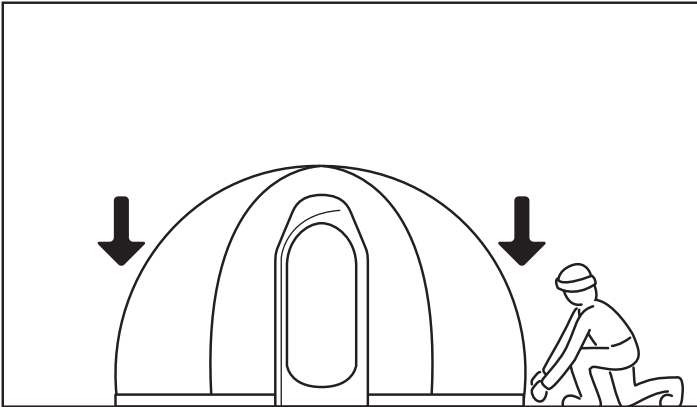

Anchorage

Your Igloopod must be fixed to the ground by provided clamps and screws at 20 points near the connection points. Weight bags must be accompanied with clamps and screws for the strongest anchoring. On soft grounds where clamps and screws are not applicable, you must use all 14 weight bags. (p.20) !

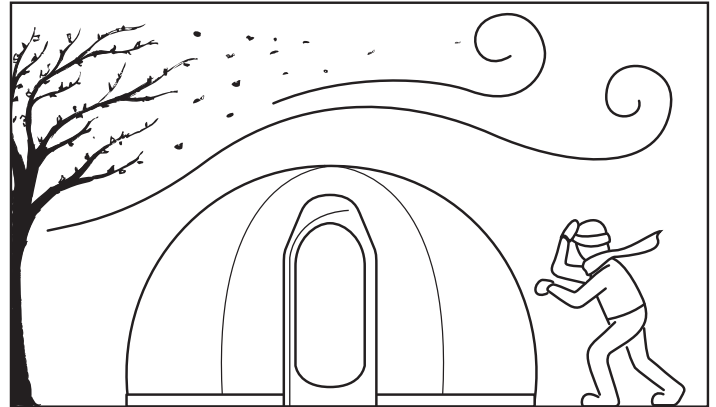

Wind resistance

Under proper conditions* Igloopod withstands strong wind conditions (Beaufort scale 6 - up to 50 km/h).

**Properly anchored on hard surfaces or with the base weight bags on soft surfaces, all air vents and door zippers are closed.*

Removal of the transparent cover is recommended if there is a storm or hurricane alert (Beaufort scale 7 and up).

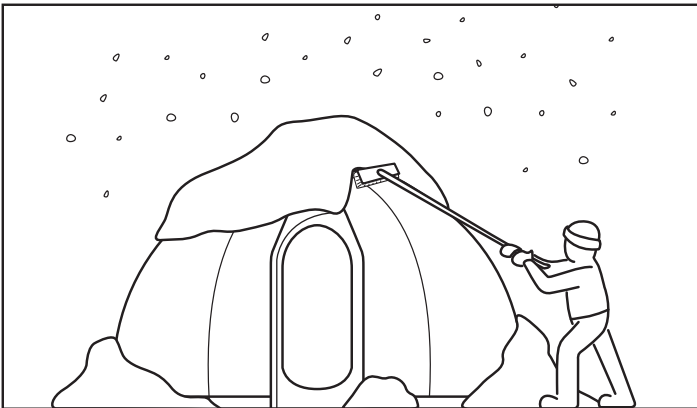

Snow resistance

Igloopod has a maximum snow load capacity of 90 lbs. You need to broom off the snow regularly to prevent collapsing.

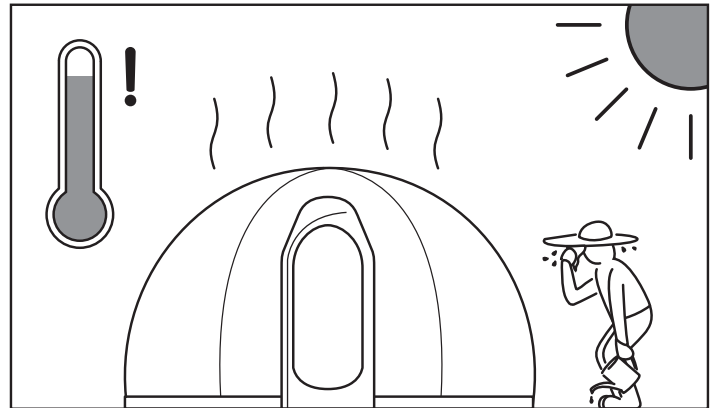

Heat and UV resistance

Igloopod's structure is stable at temperatures ranging from -20°C and +60°C (inner temp.) and withstands exposure to the sun up to UV index 5. However, during sunny spring - summer days, when the outside temperature is above +10°C, the interior air temperature can rise to excessive heat levels (+60°C).

These conditions may harm your Igloopod structure, the furniture inside, or your pets and plants.

The sunlight is always transmitted at right angles throughout the day for four seasons, delivering maximum radiant energy into the dome shape. When the outside temperature is above +10°C, it is HIGHLY RECOMMENDED to monitor the interior temperature of Igloopod, to keep the air vents open during day time, and to completely remove the transparent cover when the interior temperature exceeds +60°C. Protecting your transparent cover from high UV exposure will extend its service life.

If this recommendation is not complied with, there will be inevitable heat damage to your Igloopod structure, any furniture inside, or your pets and plants. In such cases, ODDO Ltd. will not be liable for heat damages and we do not provide a guarantee against such damage due to misuse.

Using heaters in your Igloopod

We urge you to use outdoor-type electric space heaters. Never use the following types as heat sources; Gas, Propane, Coal/Charcoal, OR Open Fire Heating.



Disassembling your Igloopod

To disassemble your Igloopod, follow the assembling steps in reverse order (from step 16 to step 1). Remove all the joints from the struts. The struts can be wet due to moist conditions, using a garden glove will help increase your grip.

The cover might be damaged if it contacts cigarettes and other flame sources. Do not machine-wash, bleach, tumble dry, iron, or dry-clean. Use a moist microfiber cloth for cleaning the cover.



WARRANTY

We guarantee that the materials and workmanship in every Igloopod product will stand up to its intended use. We offer a 1-year limited warranty from to purchase date for faults in manufacture. We will always attempt a repair and offer spare parts before replacement, where possible.

We do not provide a warranty against failure or damage due to the alteration of the product. We don't offer alterations or modifications for any of our products, as they may hinder the product's original design and therefore jeopardize its performance. This would void the warranty on the item.

This warranty does not cover failure or damages due to misuse or damages sustained after purchase, damages caused by improper care, accidents or incorrect anchoring, poor maintenance, abuse or neglect, abrasions, tears, UV degradation or using the product outside its intended use, or the natural breakdown of materials over time.

A product showing signs of age (fabric that's become thin or faded, or has developed tears; a zipper that no longer catches; fraying cuffs, etc.) is often the result of natural breakdown. We'll take this into consideration when evaluating your warranty claim. Products should be returned to us for evaluation, and will be repaired or replaced at our discretion.

The warranty process:

For international warranty questions or claims, please contact the Igloopod representative in your country. Check our web site -www.igloopod.co.uk- for a list of international subsidiaries and distributors.

Please note:

Customers are responsible for shipping items to Igloopod. We will cover the return shipping. Please ensure that you ship the product with a reputable carrier that can provide tracking information and proof of delivery. Customers are responsible for their product until we sign for delivery. All shipping must be pre-paid and insured. Igloopod cannot be held responsible for packages lost in transit.

TO ALL COMMERCIAL USERS:

1-We urge you to check with your local Fire Department and Local Building Code to see if the Igloopod may be possibly ineligible for use in your area. (Such as commercial use, specific regulations regarding size and so on.) The Igloopod's intended use is for recreational purposes, to the owner's discretion. **Although the Igloopod itself may cause no harm, such authority is tied to regulations.**

2-We as ODDO Ltd. must mention that very rarely such issues came up regarding "Fire Retardancy" and "Building code". These issues then were solved by providing various documentation. **Please understand that if the Igloopod does not match up with regulations of your area, it will be difficult to help your circumstances.**

3-We as ODDO Ltd. **are willing to cooperate with any Fire Department / Local Council with concerns to the Igloopod product.** We will provide inspectors / owners / customers with test results and specifications where possible.

4-However, the regulations in your area may have some specific differences compared to nationwide standards. We as ODDO Ltd. claim that although there is no inherent fire risk, and that the utilization of the Igloopod is up to the owner's discretion. To be on the safe side, **we urge you to conduct your own research in your local vicinity so that you may fully utilize the Igloopod.**

5-When checking for info, please note that we have an available spec sheet on our website. Issues regarding regulation can tend to be tricky, so be sure to compare what is dictated to what information has been provided to you. (Such as size, a unique certification, snow load, resistance, height, etc.)

6-You may always contact us on E-mail or by phone to ask questions and advice regarding any issues concerning the Igloopod's utilization and assembly.

www.igloopod.co.uk

ODDO LTD

Company Number : 14202506

284 CHASE ROAD A BLOCK 2ND FLOOR LONDON UK N14 6HF

Phone: (754) 222-9124