

oneisall

# Pet Grooming Vacuum

## LM5 Manual

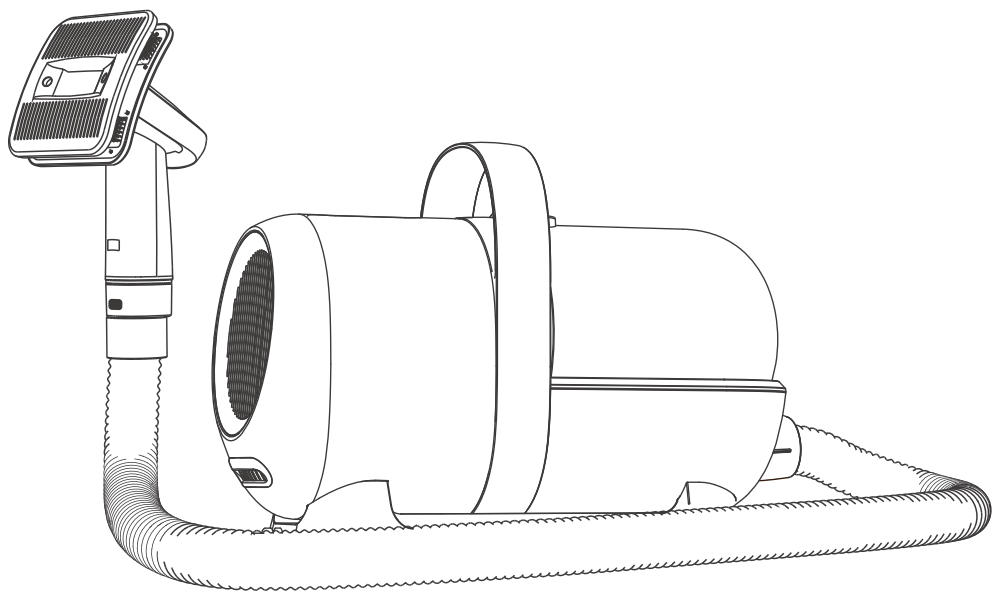

ON-D103

## Safety Warnings and Use Precautions

---

- This product is only for home use, not for commercial or industrial use, nor for outdoor or humid places.
- Supervise use for children and people with physical and mental disabilities.
- Please use the machine in a safe environment and under the instruction and supervision of a person who understands the safe use method and dangers of the product. In the absence of such a person, never let a child use it.
- Please pay attention when using it near children and pets. In addition, please do not let children and pets play with this product.
- Please do not touch the power plug and the product with wet hands.
- Do not use this product if the power cord or power plug is damaged.
- Do not use this product if the power cord is damaged or if the product is not working normally or damaged; contact our company.
- Please do not disassemble the product; the wrong assembly method may cause electric shock or fire; please contact our company if maintenance is needed.
- Please do not inhale flammable or combustible liquids such as gasoline; in addition, please do not use the machine in or near an environment with flammable or combustible gases.
- Do not pull the power cord, do not put heavy objects on top of the machine, and do not pinch the cord.
- Do not use it while smoking or working with other high-temperature items (matches, hot ash, etc.).
- Please do not put things into the opening or block the opening.
- Please unplug the power cord when you need to change the parts or conduct maintenance.
- Please do not use or keep it outdoors or in other wet places.
- Please do not use products with fragrance as the fragrance may contain flammable chemicals.

## Use Precautions

---

- Please do not operate with wet hands or unplug the power cord to avoid failure and electric shock.
- Please do not smoke or use other flammable material.
- Please do not use the machine in or near an environment with flammable or combustible gases.
- There may be a strange smell during the first use; however, it will not cause adverse effects on the body.
- When using this product for the first time, it will smell, but it will disappear after a while. Please understand, however, that if the scorching smell persists, stop using it immediately!
- Please keep the dust cup and filter clean; if the dust cup and filter are used while dirty, they may cause failure, and unexpected accidents may occur.
- During maintenance, turn off the power supply and unplug the power cord before proceeding.
- If the power is turned on for maintenance, it will cause electric shock, unexpected accidents, or injury.
- The product will stop working when the temperature rises abnormally; in case of abnormal heating of the motor, stop using it immediately. If the suction opening is blocked, please stop using it immediately. Take out the dust cup and clean the inlet and filter, then open it again after 60 minutes.
- Please be sure to install and use the filter; if you remove the filter, it will lead to failure.

# Contents

---

<b>Package List</b>	<b>01</b>
<b>Product Overview</b>	<b>02</b>
<b>Product Technical Parameters</b>	<b>02</b>
<b>Operation Instructions</b>	<b>03</b>
Accessory Combination	03
Ready to Use	03
Use of Different Accessories	05
Accessory and Power Mode	07
<b>Maintenance</b>	<b>08</b>
How to Clean Dust Cup	08
How to Clean HEPA	09
How to Clean the Sponge Filter	09
<b>QA</b>	<b>10</b>
<b>Warranty</b>	<b>11</b>

# Package List

---

---

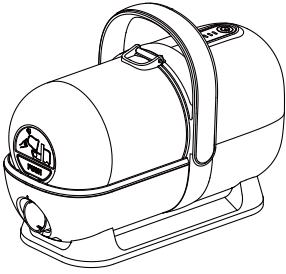

Main Vacuum Machine x 1



Hose x 1



Crevice Tool x 1

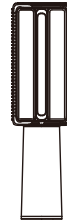

Cleaning Brush x 1

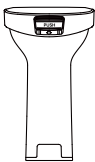

Deshedding  
Brush x 1

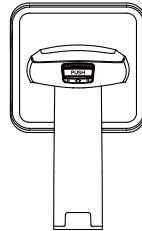

Grooming  
Brush x 1

## Product Overview

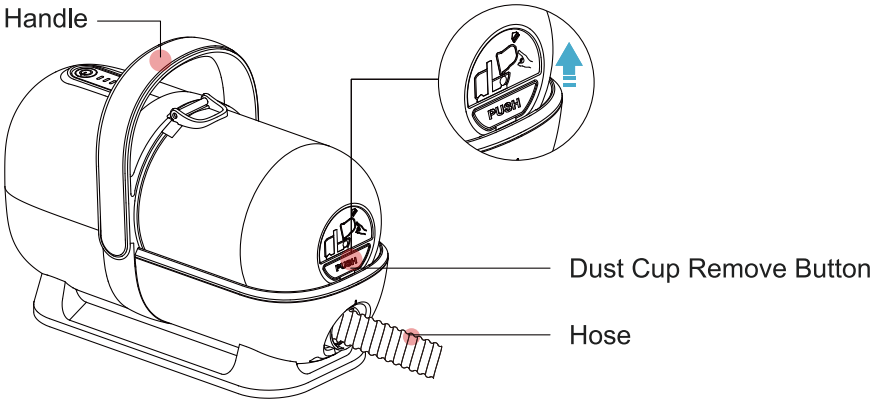
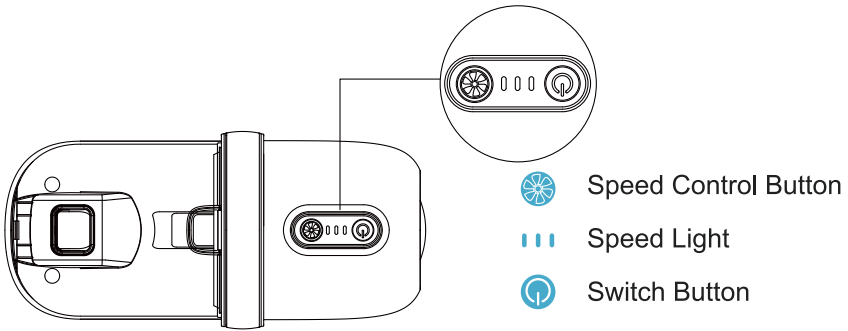

## Product Technical Parameters

Input	UK:220V-240V~50Hz/US:110V~130V~60Hz
Power	300W
Hose Length	1.5M
Dust Cup Capacity	1.5L
Product Size	302X220X130MM
Wire Length	2.5M
Maximum Noise	60dB

# Operation Instructions

## 1. Install the Dust Cup

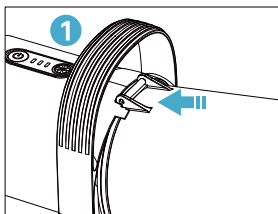

1. Align the snap-fit.

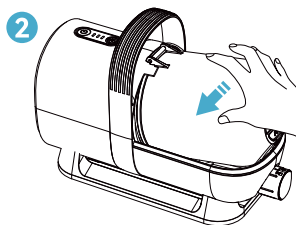

2. Press the dust cup down by your hand.

### **NOTE**

If the device has no suction or is very noisy, please reinstall the dust cup.

## 2. Ready to Use

1. Connect the accessory to the vacuum cleaner through the hose.

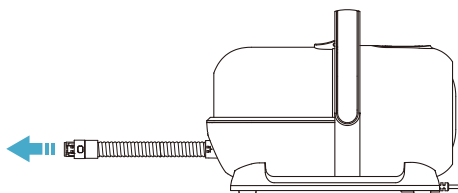
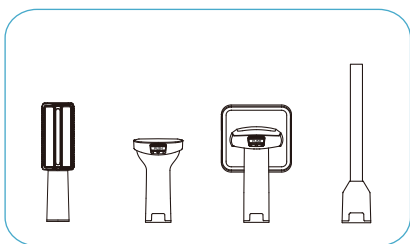

2. Insert the plug into the socket.

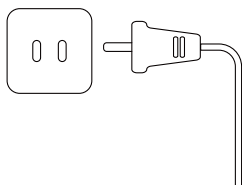

3. Turn on the switch and begin vacuuming.

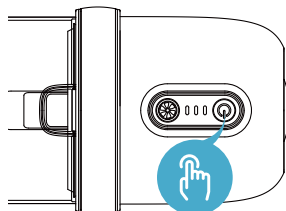

4. Select the speed you need. We suggest starting with silence mode for first-time use.

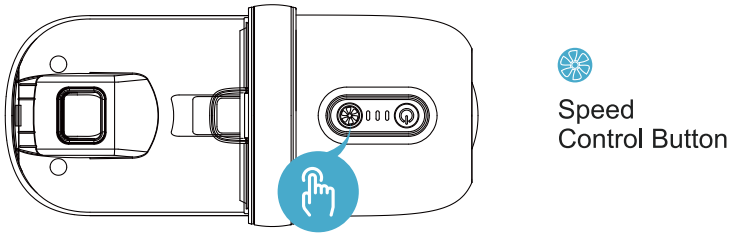

5. Grooming Your Pet.

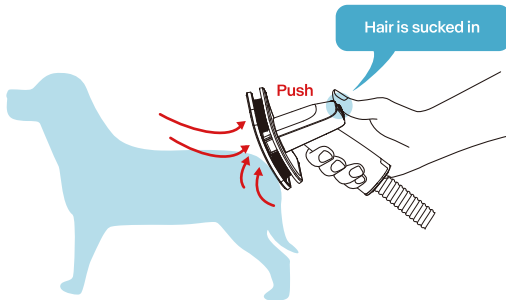

6. The hair you collect can go straight into the trash.

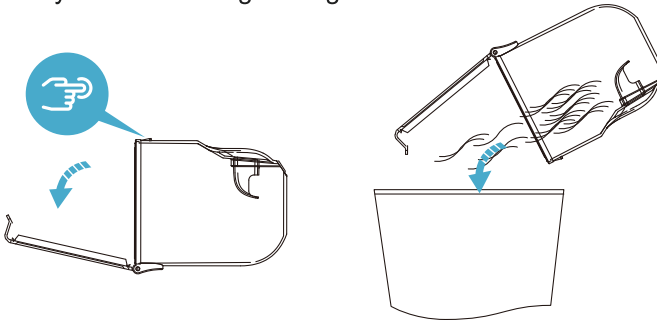

**! NOTE**

There are 3 Cleaning Modes: Silence Mode, Standard Mode, and Max Mode.

We suggest starting with the Silence Mode for first-time use as your pet will slowly get used to the noise.



# Use of Different Accessories

---

## 1. Daily Grooming Brush

Used to clean floating hair and dander, making the hair more healthy, shiny, and soft.

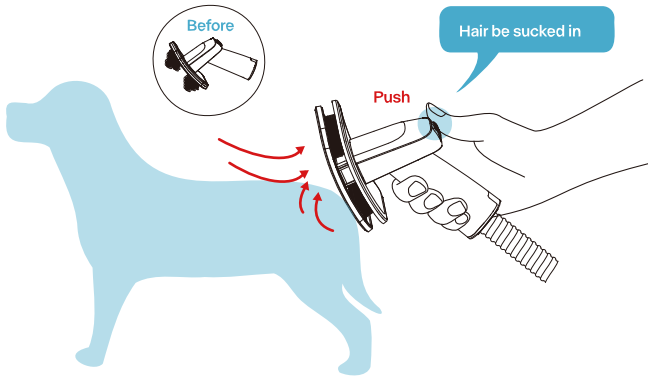

## 2. De-shedding Brush

Used to remove the pet's long and unnecessary thick hair.

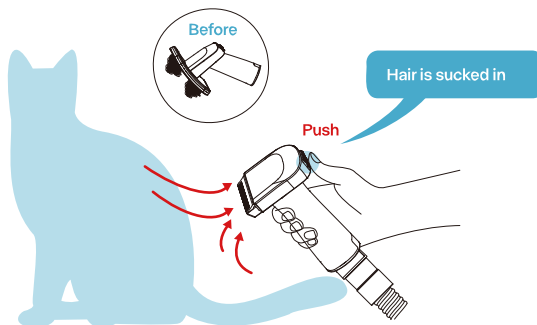

### **NOTE**

During use, pay attention to the cutting edge and position, do not use excessive force as it causes skin irritation.

### 3. Cleaning Brush

Used to clean pet's paws or pet hair on clothes and furniture.

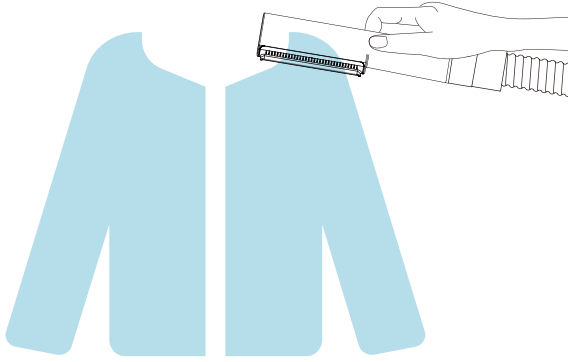



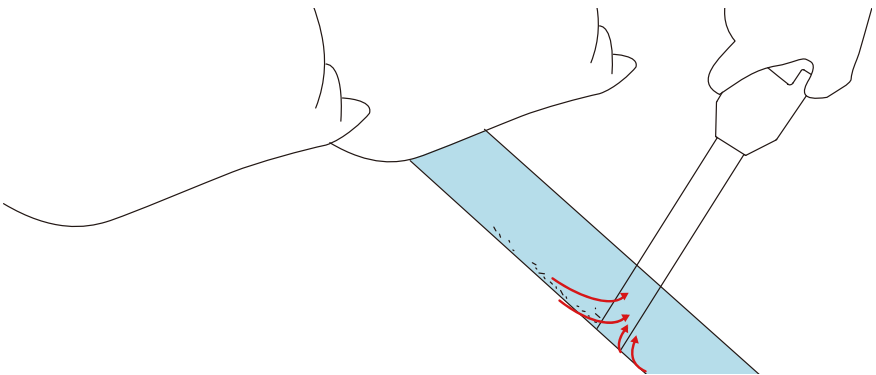

### 4. Crevice Tool

Used to clean hair on the furniture and or hard-to-reach areas.



## Accessory and Power Mode

- The following chart is for advice only, please choose accessories and modes according to your needs!

Accessory	Power Mode		
	Silence Mode	Standard Mode	Max Mode
	Cleans fallen hair from the sofa, corner, or other hard-to-reach areas.	Cleans the fallen hair from the sofa, corner, or other hard-to-reach areas.	Deep cleaning of stubborn dust. (A little noisy, but recommended)
	Cleans surface dust and makes the hair smooth.	Airflow massage makes the hair glossy. (Recommended)	Deep cleaning to remove dead hair. (A little noisy)
	Soft suction power to clean the pet hair on clothes.	Deep clean hair on your clothes.	Strong suction power. (A little noisy, but recommended)
	Remove loose hair.	With soft suction to de-shed pet hair.	Suction to de-shed pet hair. (A little noisy)

# Care and Maintenance

## Cleaning the Dust Cup

1. Press the remove button and take off the dust cup.

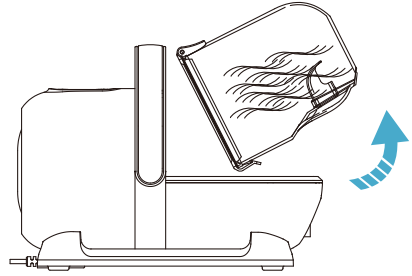
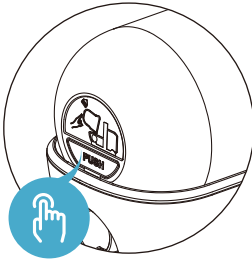

2. Press the release button and pour out the hair.

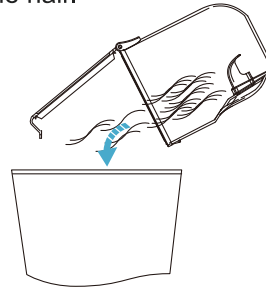
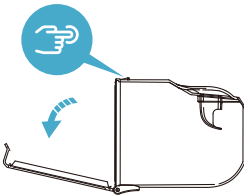

3. Assemble the dust cup according to the arrow direction.

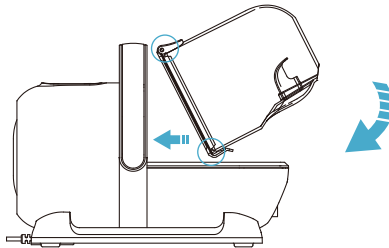

- If the removed dust cup is cleaned with water or a wet cloth, be sure to install it after the dust cup is completely dry. Otherwise, it will damage the motor.
- Please take dust cup lightly, if it drops will damaged easily, if have any problems with the cup, please contact us on Amazon or contact us email: [support@oneisall.com](mailto:support@oneisall.com)

## Cleaning the HEPA & Sponge Filter

1. Remove the dust cup and remove the HEPA & sponge filter.

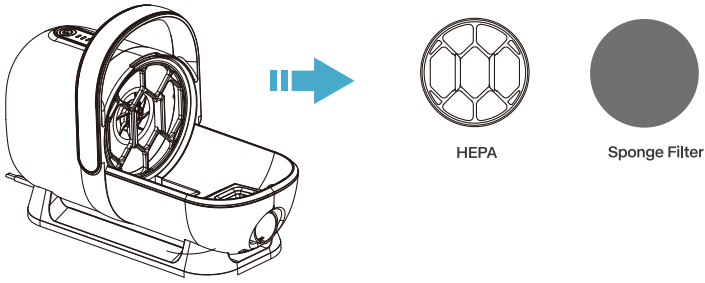

2. Tap it or clean it with brush. Don't wash it with water.

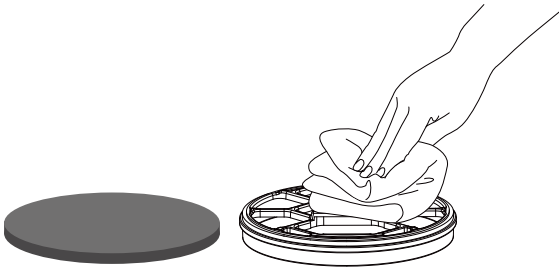

3. Place the HEPA & sponge filter back into the machine.

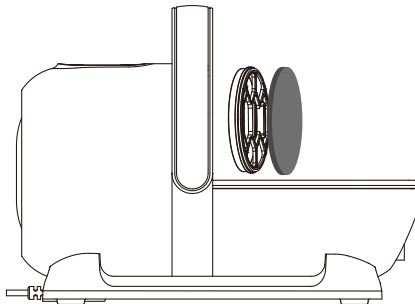

 **NOTE**

The product is equipped with voltage protection device. If you hear a "didi" sound when you press the switch, and the gear lights are all flashing, it means that the machine voltage is not consistent. Please check your voltage. If you have any problems, please contact us at any time with our email [support@oneisall.com](mailto:support@oneisall.com)

### Troubleshooting

Problems	Possible Causes	Solutions
Cannot be turned on	Plug not been inserted well	Reinsert the plug
	Switch not been turned on	Press switch button to turn it on
Weak suction	Flexible hose is clogged	Clean flexible hose and suction mouth
	Dust cup is too full	Empty dust cup
	Filter is dirty	Clean filter
The hose is broken	Accidental damage	The hose is detachable and can be stored in the bag we provided
	Bitten by pets at home	
Whistle-like noise when the machine is running	The Dust Cup snap is not aligned	Please check whether the Dust Cup is installed

- If the above solutions do not solve the problem, please stop using the product, and contact our customer support: [support@oneisall.com](mailto:support@oneisall.com)

## Warranty

---

**The Warranty Team Provides You With Specific Legal Rights; You May Also Have Other Rights Which Vary From State To State.**

### **12-Month Warranty & Lifetime Customer Support**

Only applies to eligible purchases made directly from oneisall authorized distributors. Warranty coverage applies to the original owner and to the original product only and is not transferable.

### **How to Initiate a Warranty Claim**

If your appliance operates improperly while in use under normal household conditions within the warranty period, please contact our customer support team [[support@oneisall.com](mailto:support@oneisall.com)] to initiate a warranty claim.

For more warranty details, please refer to [www.oneisall.com](http://www.oneisall.com).  
All rights are reserved by oneisall official website.

# oneisall

Any problems you have, please contact us :  
[support@oneisall.com](mailto:support@oneisall.com)



Scan the QR-Code to get the product  
installation video and join us to get  
more prize

ON-D103