

oneisall<sup>®</sup>

# Pet Grooming Vacuum

Model: BM3

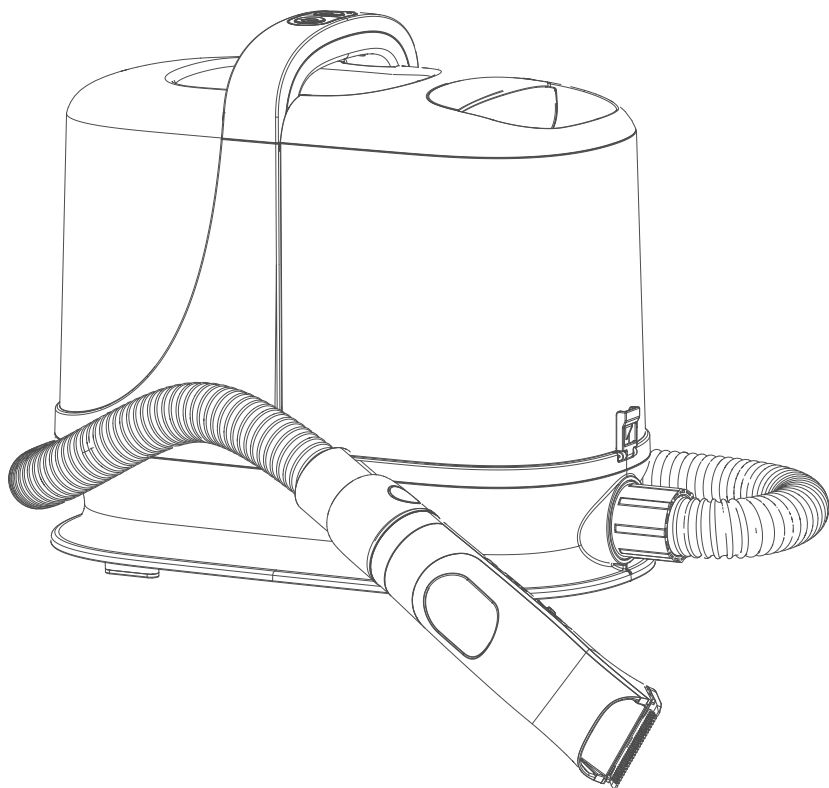

ON-D106

## Safety Warnings and Use Precautions

---

- This product is intended for home grooming only, not for commercial or industrial use, nor for use outdoors or in humid places.
- Supervise use for children and people with physical and mental disabilities.
- Please use the machine in a safe environment and under the instruction. Supervision of a person who understands the safe use method and dangers of the product. In the absence of such a person, never let a child use it.
- Please pay attention when using it near children and pets. In addition, please do not let children and pets play with this product.
- Please do not touch the power plug and the product with wet hands.
- Do not use this product if the power cord or power plug is damaged.
- If you find the product can not work or damage or immersion in liquid, contact us. Please do not disassemble the product; the wrong assembly method may cause electric shock or fire; please contact our company if maintenance is needed.
- Please do not inhale flammable or combustible liquids such as gasoline. in addition, please do not use the machine in or near an environment with flammable or combustible gases.
- Do not pull the power cord, do not put heavy objects on top of the machine, and do not pinch the cord.
- Do not use it while smoking or working with other high-temperature items (matches, hot ash, etc.).
- Ensure that the opening is not blocked before use.
- Please unplug the power cord when you need to conduct maintenance.
- Please do not use or keep it outdoors or in other wet places.
- Please do not use products with fragrance as the fragrance may contain flammable chemicals.
- Please only use this product under the specified voltage, which can be found at the bottom of the machine.

## Use Precautions

---

DO NOT operate with wet hands or unplug the power cord to avoid electric shock.

DO NOT smoke or use other flammable material.

Please do not use the machine in or near an environment with flammable or combustible gases.

There may be a strange smell during the first use; however, it will not cause adverse effects on the body and will disappear after a while.

If the scorching smell persists, stop using it immediately!

Please keep the dust cup and filter clean.

If the dust cup and filter are used while dirty, they may cause product issue.

During maintenance, turn off the power supply and unplug the power cord before proceeding.

If the power is turned on for maintenance, it will cause electric shock, unexpected accidents, or injury.

The product will stop working when the temperature rises abnormally.

In case of abnormal heating of the motor, stop using it immediately.

If the suction opening is blocked, please stop using it immediately.

Take out the dust cup and clean the inlet and filter, then open it again after 60 minutes.

Please be sure to install and use the filter.

If you remove the filter, it will damage the motor.

## Use Precautions

---

---

Package List	01
Product Overview	02
How to Do if My Pets Get Nervous?	03
Get Started	04
Tips for Accessories Option	07
Maintenance	12
Specifications	17
Warranty	18



oneisall Official  
Community



oneisall support



Tutorial Video

# Package List

---



Main Vacuum Machine x 1

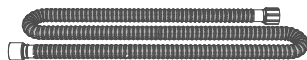

Hose x 1



(3-6-9-12-18-24mm) Guide combs x 6

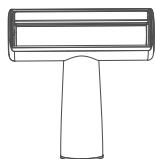

Pet Hair Remover Roller



Slicker Brush

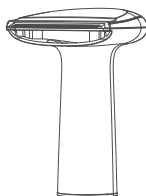

Deshedding Brush



Pet Clippers



Pet Paw Trimmer



Pet Nail Grinder



Long Narrow Nozzle



Storage bag



USB charging cord for clippers



Brush x 1

# Product Overview

---

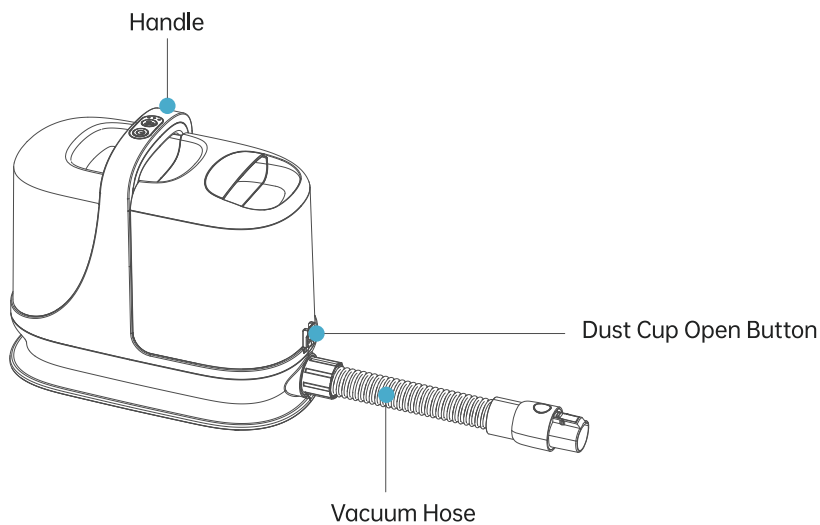
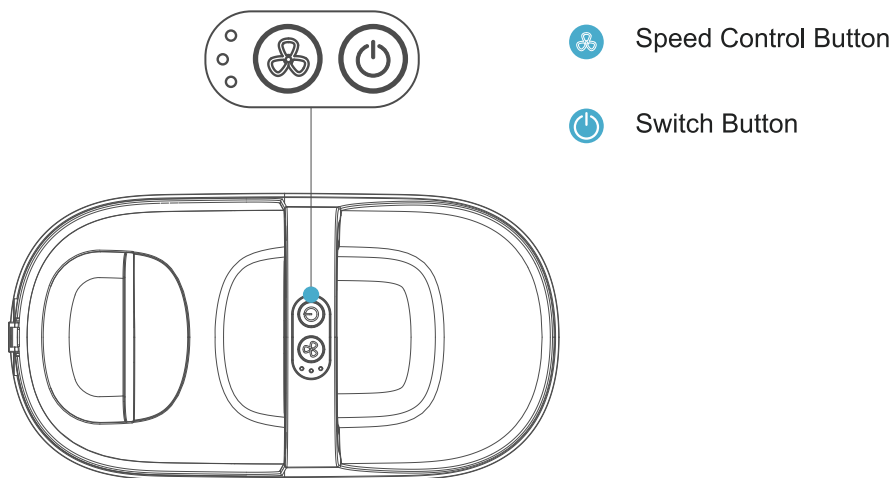

## How to Do if My Pets Get Nervous?

If your pet is nervous about the noise or the air flow, you may need to let him get used to the machine at first.

1. Let your pet hear the sound of the machine or feel the slower air flow.

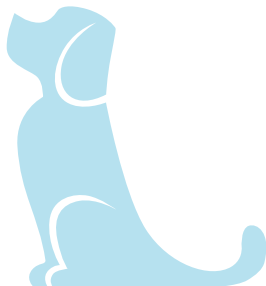
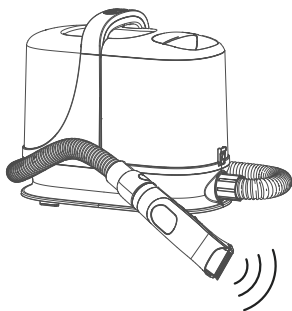

2. Treat your pet with snack.



3. Start to use the vacuum. If your pet still get nervous, try to repeat 1-2 to let him know that this machine would not do harm to him.

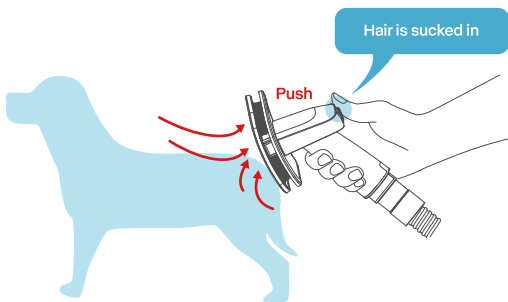

# Get Started

## Get Ready

1. Put the dust cup gently in the direction of the arrow.

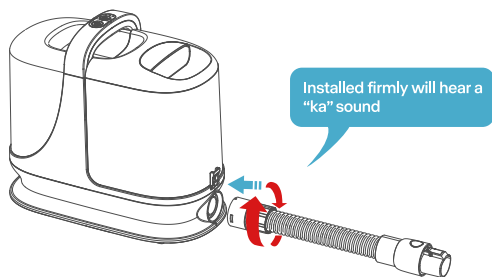

2. Connect the Accessory to the Vacuum Cleaner Through the Hose.

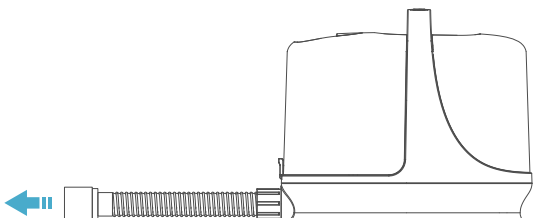

When using accessories, please pay attention to the edges of the accessories to avoid scratching your hands

3. Connect the power supply.

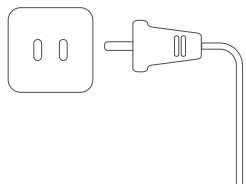

4. Press the on/off button

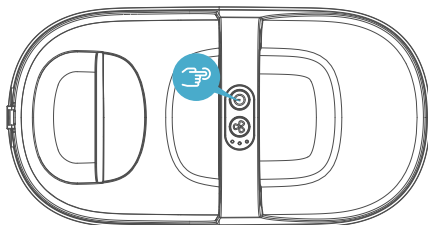



## 5. Select speed

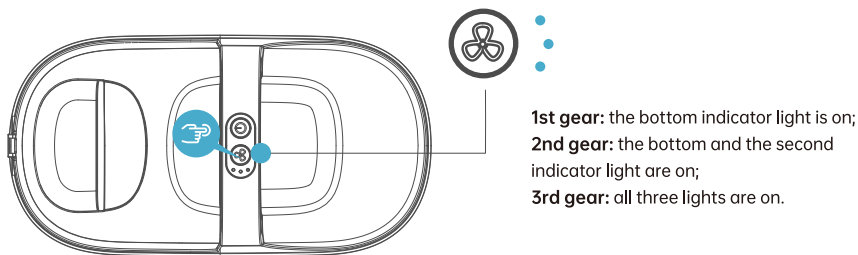

## 6. Shutdown Memory Gear.

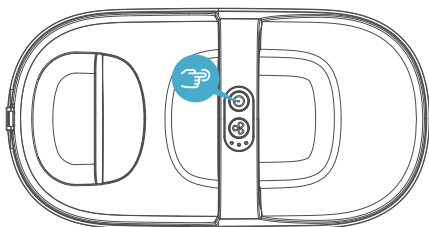

### **NOTE**

Press the power button to shut down during operation, and the next time it is turned on, it will default to the gear before shutting down.  
For example: Press the power button to turn off the power at the second gear, then press the power button again, The machine is on and running in 2nd gear. After the power is cut off, the gear position will not be memorized.  
For example, after the 3rd gear is running, the machine will be turned off and the plug will be unplugged.  
At this time, turn on the power and then turn on the machine, the machine will start and run in 1st gear.

7. Groom your pet.

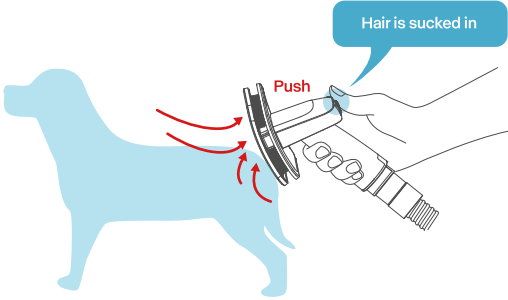

8. Clean the dust cup.

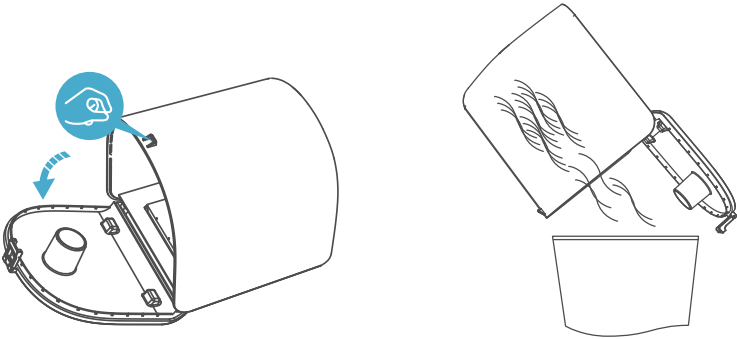

## Tips for Accessories Option

### Deshedding brush

Curved comb teeth can fit the back and head well. Used to remove the pet's long and unnecessary thick hair.

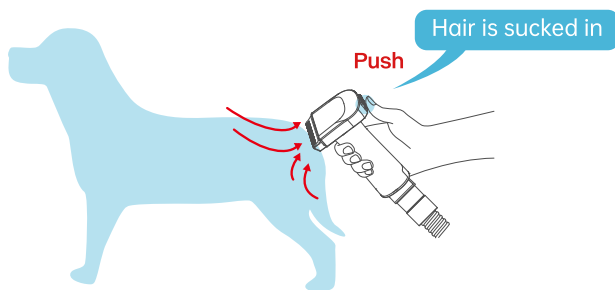

### ⚠ NOTE

Please be careful with the soft parts of your pet and do not use excessive force to cause skin scratches.

Please pop up the PUSH button when you do not need to use it.

### Slicker brush

A larger area of comb teeth is suitable for large dogs with thick fur, used to remove the loosen hair and the dander inside the coats. Making the hair more fluffy and healthy.

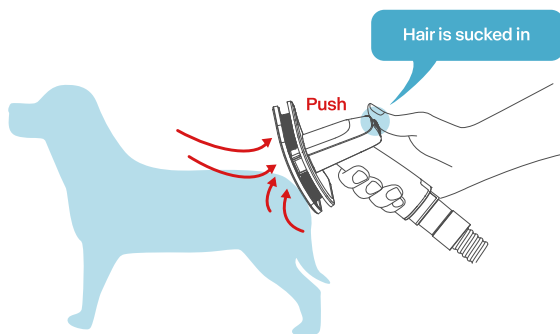

## Pet Clippers

- 1) Used to trim the pet's hair without leaving a mess as the hair will not fly around.
- 2) While cutting, it suctions the cut hair!

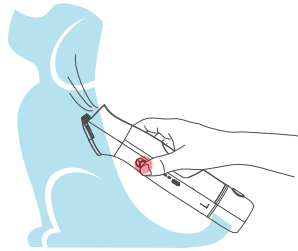
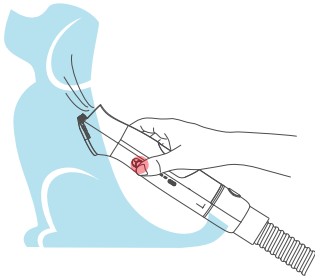

Use with vacuum or the clippers alone.

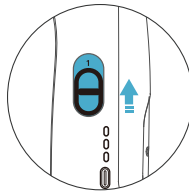
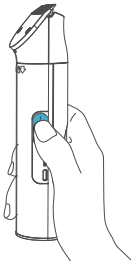

Turn on slide up.

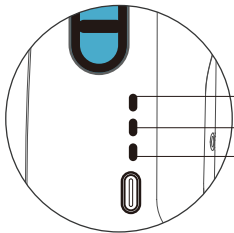

70%-100% battery left (3 Blue lights stay on when fully charged)

40%-69% battery left

0-39% battery left (Red light flashes when less than 10% battery left)

### **NOTE**

Remember to pay attention to the cutting edge and position, and do not use excessive force as it causes skin irritation.

## How to Replace Accessory Heads?

Installation and disassemble method of pet clippers: hold the pet clippers with one hand, and install or dismantle it in the direction of the arrow with force.

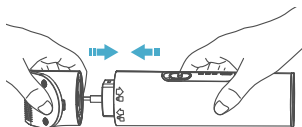
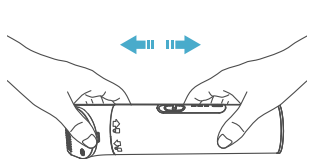

### Replaceable accessory head:



pet paw trimmer



dog nail grinder



pet clippers

**Disassembly:** Hold the product with one hand and push down the accessory head with the other hand.

**Installation:** Hold the product with one hand and follow the arrows to install the replacement head.

**Note:** The protective cover on top of the nail grinder is rotatable, you can rotate the cover according to your own needs (Pictures are needed here to guide you).

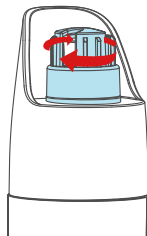
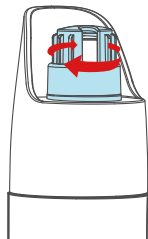

## Pet Paw Trimmer

Used to groom pet's paws, eyes, ears, face, and rump hair.



### **NOTE**

During use, pay attention to the cutting edge and position, do not use excessive force as it causes skin irritation.

## Pet Nail Grinder

Used to groom your pet's nails.

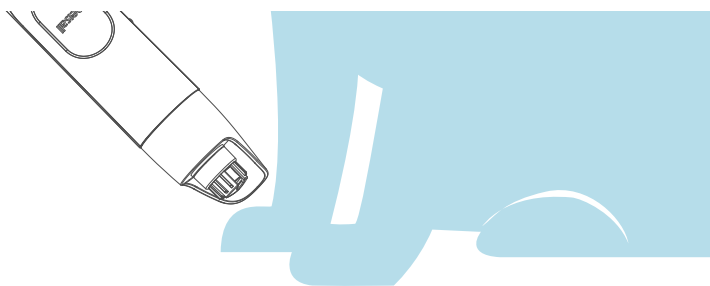

### **NOTE**

Be careful on the soft parts of the pet's skin, and do not use excessive force as it causes skin irritation.

## Install Guide Comb (used with electric clippers)

Choose the length guide comb according to the length of pet hair you want to leave. The guide comb ((3mm/6mm/9mm/12mm/18mm/24mm)) is applicable for grooming different hair lengths.

The guide comb set is small; keep it stored properly when it is not in use.



3mm (1/8")



6mm (1/4")



9mm (3/8")



12mm (1/2")



18mm (3/4")



24mm (1")

## Long narrow nozzle

Used to clean carpet, sofa corners, car, cat tree and cat nest.

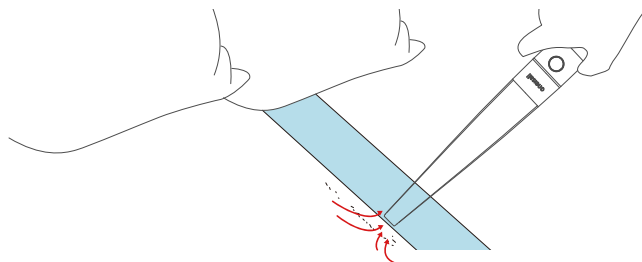

## Pet hair remover roller

Effectively remove pet hair that stuck to clothing.







Use with vacuum or the hair remover alone.

### **NOTE**

Roll the remover back and forth.  
Do Not roll it in one direction all the time.

## Accessory and Power Mode

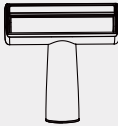
- The following chart is for advice only, please choose accessories and modes according to your needs!

Accessory	Power Mode		
	Silence Mode	Standard Mode	Max Mode
	Cleans fallen hair from the sofa, corner, or other hard-to-reach areas.	Cleans the fallen hair from the sofa, corner, or other hard-to-reach areas.	Deep cleaning of stubborn dust. (A little noisy, but recommended)
	Cleans surface dust and makes the hair smooth.	Airflow massage makes the hair glossy. (Recommended)	Deep cleaning to remove dead hair. (A little noisy)
	Trim styling, handling hairstyle detail. (Recommended)	With soft suction to trim and suck removed hair.	Don't recommend.
	Soft suction power to clean the pet hair on clothes.	Deep clean hair on your clothes.	Strong suction power. (A little noisy, but recommended)
	Remove loose hair.	With soft suction to de-shed pet hair.	Suction to de-shed pet hair. (A little noisy)
	For dog and cat paws, eyes, ears, face, and rump hair.	With soft suction to trim and suck removed hair.	Don't recommend.
	Polish your pet's nails by rounding them out.	With soft suction to trim pet's nails.	Don't recommend.



# Maintenance

## Clean the dust cup

1. Cut off the power.

Put your finger on the tail of the dust cup.

(Follow the arrows for directions)

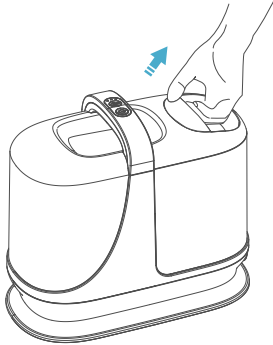

2. Open the lid and pour out.

Push the catch to open the dust cup and pour out the lint.

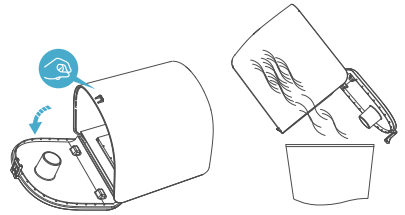

3. Placement of the dust cup

Simply install the dust cup in the direction of the arrow.

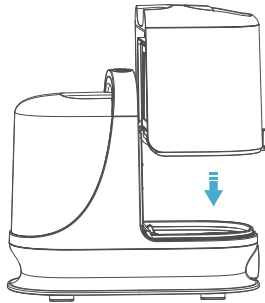

### **NOTE**

1. If the removed dust cup is cleaned with water or a wet cloth, be sure to install it after the dust cup is completely dry. Otherwise, it will damage the motor.

2. Please take dust cup lightly. If it drops will damaged easily. If have any problems with the cup, please contact us on Amazon or contact us email: [support@oneisall.com](mailto:support@oneisall.com)

## Clean the blades of pet clippers

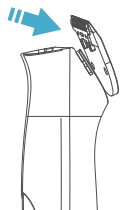

1. Push the blades out by hands.
2. Brush and wash the blades.
3. Dry the blades with cloth and drop oil.
4. Align the slot under the blades and press to install the blades.

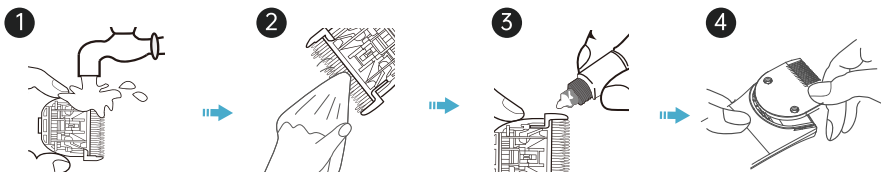

### **NOTE**

Oil is not included in the package. Please order it by yourself.

## Clean the Metal Screen and Filter Sponge in the Dust Cup

Step 1: Remove the dust bin by pulling it diagonally upwards from the main unit.

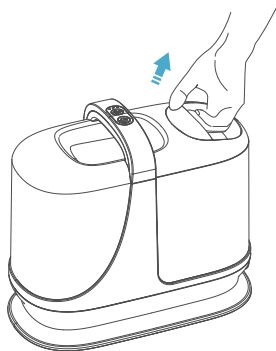

Step 2: Snap open

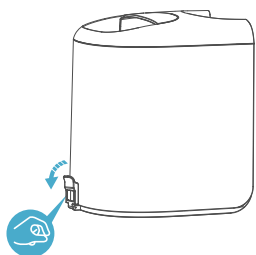

Step 3: Open the bottom cover and clean the dust bin first to clean out the hairs inside.

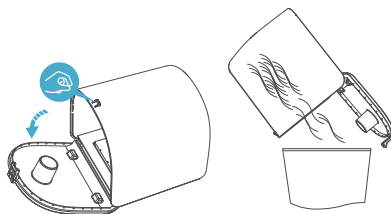

Step 4: Remove the filter pads and filter screen by jacking outwards from inside the dust bin and clean the pads and filter screen, then put them back in their original position accordingly.

**Note: Do not wash filter Pads and filter screen them with water**

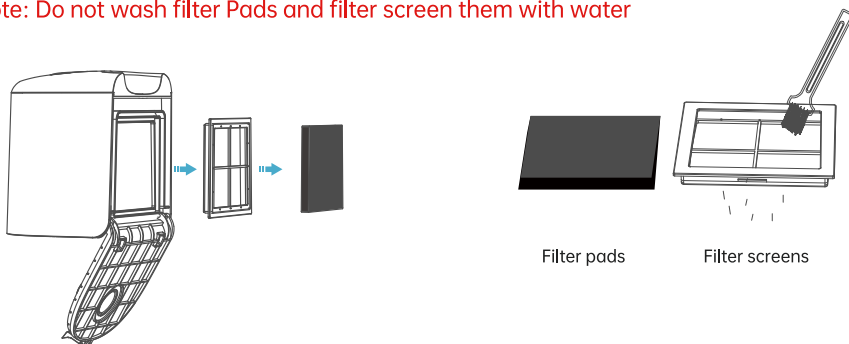

Filter pads

Filter screens

**NOTE**

- The filter should be cleaned with cold water at least every other month.
- Please follow the frequency of use and conditions, the maintenance period is also different, regularly confirm if it is dirty, clean it.
- When cleaning, remember to disconnect the power supply and unplug the plug from the socket.
- Be sure to install HEPA after drying.
- No-yet-dry HEPA can cause electric shock and malfunction.

## Cleaning the HEPA & Sponge Filter

Step 1: Remove the dust cup and remove the HEPA & sponge filter.

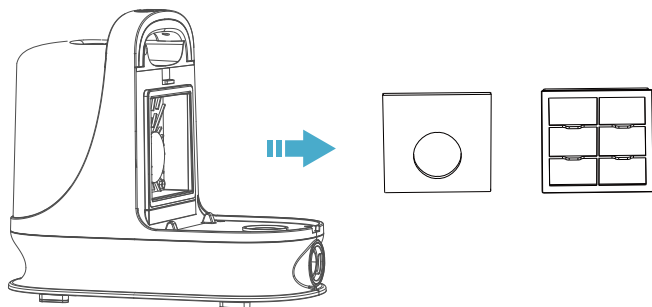

Step 2. Clean them with brush.

**Note: Do not wash filter Pads and filter screen them with water.**

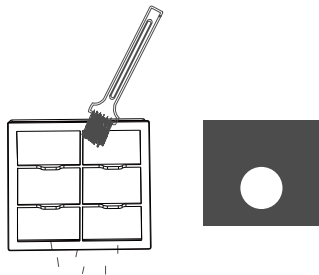

Step 3. Place the HEPA & sponge filter back into the machine.

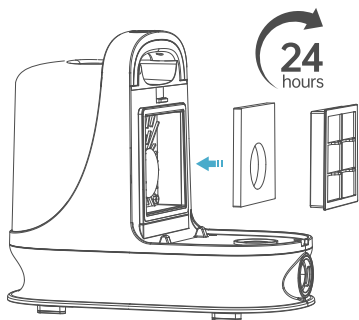

## Troubleshooting

Problems	Possible Causes	Solutions
Cannot be turned on	Plug not been inserted well	Plug the charger again
	Switch has not been turned on right	Please contact our customer support: <a href="mailto:support@oneisall.com">support@oneisall.com</a>
Weak suction	Hose is clogged	Clean the hose and joint
	Dust cup is too full	Empty dust cup
	Filter is dirty	Clean filter
The Pet Clippers heats up during use	Debris stay in the internal parts of the clippers	Please remove the blade. Wash and oil
The hose is broken	Accidental damage	Remove the hoses and store them in the bag we provided.
	Bitten by pets at home	

- If the above solutions do not solve the problem, please stop using the product, and contact our customer support: [support@oneisall.com](mailto:support@oneisall.com)

# Specifications

---

## The Main Machine

Input voltage	120V~60Hz
Rated power	350W
Hose length	1.6M
Dust cup capacity	3L
Size of the main machine	12.8 x 8.7 x 5 inch
Power cord length	2.2M
Noise	60dB

## Pet Clippers

Input voltage (Pet clippers)	DC 5V $\approx$ 1A
Rated power	5W
Charging time	About 3h
Working time	About 2h
Battery capacity	1400mAh

## Contact Us

---

### WE ARE READY TO HELP

Oneisall offers a standard **2-year** warranty. If you have any issues with your Oneisall product, please do not hesitate to contact us. Be sure to include your proof of purchase, model number, and any relevant photos or videos in your message to expedite the process. Our Oneisall support team is available 7 days a week and will respond to your inquiry within **24 hours**. Thank you for choosing Oneisall.

Please note that the Oneisall warranty does not apply to used products or purchases made from unauthorized sellers. It's important to be aware that the warranty also does not cover consumable parts such as blades, guards, filters, brushes, and similar items. These parts may require regular replacement or maintenance.

✉ [support@oneisall.com](mailto:support@oneisall.com)

📞 +1 877-522-8578 (US) **Mon-Fri** 8am-5pm(PST)

🌐 [www.oneisall.com](http://www.oneisall.com)



@Oneisall Official

# oneisall<sup>®</sup>

Any problems you have, please contact us :  
[support@oneisall.com](mailto:support@oneisall.com)



oneisall Official  
Community



oneisall support



Tutorial Video