

# Bathroom Sink Faucet Installation

## INSTALLATION MANUAL Tools You Will Need:

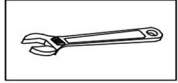

Adjustable wrench

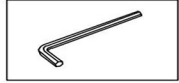

Hexagon wrench

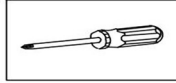

Phillips Screwdriver

## Before the Installation

1. Check the package and confirm all parts are included. If any part is missing or damaged, please contact us.
2. Do not disassemble the main body, as it has been installed & commissioned correctly & precisely before leaving the factory.
3. Shut off the main water supply prior to beginning installation.
4. Do flush the water supply lines to remove any dirt and debris before installation (**IMPORTANT**).
5. Make sure to connect the hot/cold inlet pipe correctly. If standing in front, connect hot water pipe to the left and cold water pipe to the right.
6. After the installation, check for leaks and make sure every joint is safely sealed.

## Cleaning and Maintenance

1. Rinse with clean water and dry with a soft cloth.
2. Do not use any detergent, acid, polisher, abrasives, or harsh cleaners.
3. Do not use cloth with a coarse surface.

## Parts List

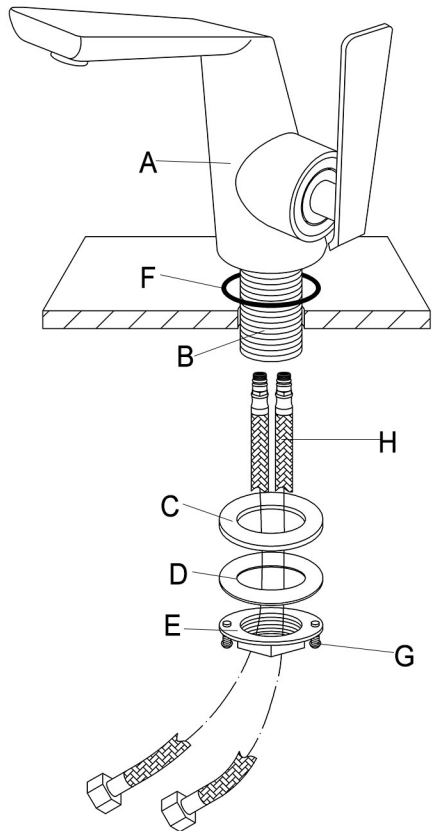

Part	Name	Quantity
A	faucet body	1
B	threaded pipe	1
C	rubber washer	1
D	metal washer	1
E	mounting nut	1
F	O-ring	1
G	mounting screws	2
H	waterlines	2

## Installation Guide

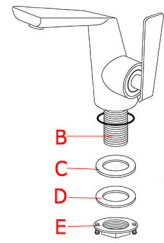

1. Remove the mounting nut (E), metal washer (D), and rubber washer (C) from the threaded pipe (B).

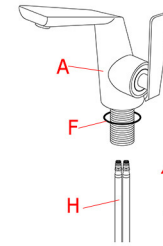

2. Fit the O-ring (F) into the bottom groove of the faucet body (A). Screw the waterlines (H) into the corresponding hole of the faucet body (A).

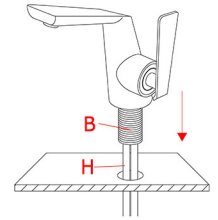

3. Insert waterlines (H) and threaded pipe (B) into the hole of the sink. (**Note:** For 3-hole installation, an escutcheon is needed.)

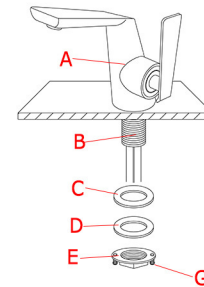

4. Install rubber washer (C), metal washer (D), and mounting nut (E) back to the threaded pipe (B). Adjust the faucet body (A) correctly and secure with mounting screws (G) tightly.

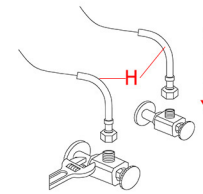

5. Connect waterlines (H) to angle stops. Turn on the angle stops and check for leaks (**DO NOT TURN FAUCET ON**).

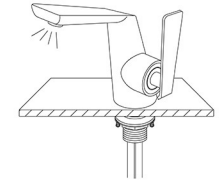

6. Turn the faucet on for 1 minute to flush any debris.

## Troubleshooting

Problem	Possible Cause	Corrective Action
Water does not shut off completely.	1. O-ring is not seated correctly or worn. 2. Cartridge may be defective.	1. Reseat or replace O-ring. 2. Replace cartridge.
Leaks at waterline connection.	1. Worn or broken washer. 2. Faucet body may be defective.	1. Replace washer. 2. Replace faucet (contact us for the replacement).
Leaks from handle.	1. Cartridge may come loose. 2. Cartridge may be defective.	1. Reseat cartridge tight. 2. Replace cartridge.
Leaks at hose connection.	1. Hose connection is loose.	1. Tighten hose. 2. Replace hose.
Leaks at shower valve connection.	1. Connection may come loose or not sealed completely. 2. Defective shower valve inlet or outlet connector.	1. Check connections. 2. Replace valve body.
Diverter knob does not work.	1. Diverter cartridge may be defective.	1. Replace cartridge.
LED light does not Light or noisy LED showerhead.	1. Defective LED generator.	1. Replace LED spray head (for kitchen faucet). 2. Replace LED threaded pipe (for separate faucet spout). 3. Replace LED generator (for others).
Low flow.	1. Check for water pressure problems. 2. Aerator may be dirty or clogged.	1. Clean or replace the aerator. 2. Remove waterflow restrictor if available. 3. Install booster or pump (if applicable).